

ESH
Protocol Embedded

AHA
Protocol Embedded

WelchAllyn[®]

Advancing Frontline Care[™]

ProBP 2400 Digital Blood Pressure Device

Directions for use



EN → 1

CAUTION Federal law restricts this device to sale by or on the order of a physician or licensed healthcare provider

powered by

microlife[®]

Introduction

This directions for use manual is a comprehensive guide designed to help you understand the capabilities and operation of the ProBP 2400 digital blood pressure device. Read this manual thoroughly before attempting to setup, configure, use, troubleshoot, or maintain the device.

Intended use

The ProBP 2400 is a non-invasive digital blood pressure device using oscillometric technique and an upper-arm blood pressure cuff to measure systolic and diastolic blood pressures, pulse rate and mean arterial pressure (MAP) for use in pediatric and adult populations with arm cuff circumference sizes ranging from 14 -52 cm.

The device detects the appearance of irregular heartbeat during measurement, and gives a warning signal with the reading once the irregular heartbeat is detected.

The device can accurately measure blood pressure in pregnant patients including those with known or suspected preeclampsia.

The ProBP 2400 combines the advantages of an automatic blood pressure device and auscultatory sphygmomanometer. It is designed to provide convenient, accurate and reliable office blood pressure measurements according to guidelines of the European Society of Hypertension (ESH)¹, American Heart Association (AHA)², and World Health Organization (WHO)³ with the only modification that the ProBP2400 performs 3 repeated measurements always, regardless of the result of the first two measurements.

Pregnancy

Approximately 20% of women develop hypertension during pregnancy (Pre-eclampsia or Toxemia) which may affect pregnancy. Pre-eclampsia, can usually be recognized by a clear increase in blood pressure and high urine protein levels after 20 weeks of gestation. Since many oscillometric devices appeared to be unsuitable for use in pregnancy and Pre-eclampsia health care authorities require that blood pressure monitors used for this vulnerable patient group are specifically tested. The Welch Allyn ProBP 2400 digital blood pressure monitor has successfully passed this validation and therefore may be recommended for use during pregnancy and Pre-eclampsia.

¹Pickering TG, Hall JE, Appel LJ, et al. Recommendations for blood pressure measurement in humans and experimental animals: part 1: blood pressure measurement in humans: a statement for professionals from the subcommittee of professional and public education of the american heart association council on high blood pressure research. *Circulation* 2005;111:697-716.

²Whitworth JA. 2003 World Health Organization (WHO)/International Society of Hypertension (ISH) statement on management of hypertension. *J Hypertens* 2003;21:1983-92.

³O'Brien E, Asmar R, Beilin L, et al. Practice guidelines of the European Society of Hypertension for clinic, ambulatory and self blood pressure measurement. *J Hypertens* 2005;23:697-701. E, Asmar R, Beilin L, Imai Y, et al. European Society of Hypertension recommendations for conventional, ambulatory and home blood pressure measurement. European Society of Hypertension Working Group on Blood Pressure Monitoring. *J Hypertens* 2005;23:697-701.2003,21:1983-1992.

Table of Contents

Symbols	6	«Manual» Mode	19-20
Warnings and cautions		«3x» Mode	21
General warnings and cautions	7-8	Special Functions	
NIBP (non-invasive blood pressure) warnings and cautions	9	MAP (Mean Arterial Pressure)	22
Product description		Irregular heartbeat detector in «1x» Mode	22
Name of parts and display	10-11	Setting maximum inflation pressure	23
Components and accessories	12	Taking fewer than three measurements	24
Before using ProBP 2400		Skipping the countdown time	24
Attaching the power plug to the power adapter	13	Setting measurement interval times in «3x» Mode	25
Selecting Units of Measure	14	Viewing the stored values	26
Selecting the correct cuff	15	Appendix	
Fitting the cuff properly	16-17	Rechargeable battery and power adapter	27
Taking measurements in Single Reading (1x), Manual and Three Reading Average (3x) Mode		Troubleshooting	28
«1x» Mode	18	Error messages	29-30
		Safety, care, accuracy test and disposal	31-34
		Technical specifications	35

Symbols

Documentation symbols



WARNING: The warning statements in this manual identify conditions or practices that could lead to illness, injury, or death.



CAUTION: The caution statements in this manual identify conditions or practices that could result in damage to the equipment or other property, or loss of data.



welchallyn.com

Consult operating instructions/directions for use (DFU). A copy of the DFU is available on this web site. A printed copy of the DFU can be ordered from Welch Allyn for delivery within 7 calendar days.



Helpful notes.

Shipping, storing, and environment symbols



Fragile; handle with care



Recovery/Recyclable



Recycle the product separate from other disposables



Keep dry

Control symbols



Power on/Power off



Start/Stop



Memory



3 sec.

Adjust measurement interval times



3 sec.

Adjust maximum inflation pressure



Single Reading Mode



Manual Mode



Three Reading Average Mode

General warnings and cautions

Miscellaneous symbols



Meets essential requirements of European Medical Device Directive 93/42/EEC



Regulatory Affairs Representative



Type BF applied parts



Manufacturer



WARNING The information in this directions for use is a comprehensive guide to the operation of ProBP 2400. For best results, read this directions for use thoroughly before using the device.

WARNING The device is intended for use only in environments with clinician supervision.

WARNING The device is designed for medical clinician use. Although this directions for use may illustrate medical spot-check techniques, only a trained clinician should use this device.

WARNING The device is not intended for use during patient transport.

WARNING Fire and explosion hazard. Do not operate the device in the presence of a flammable anesthetic mixture with air, oxygen, or nitrous oxide; in oxygen enriched environments.

WARNING Every three months, inspect the blood pressure cuff and other accessories for fraying or other damage. Replace as necessary.

WARNING Inaccurate measurement risk. Do not use the device on patients who are connected to heart/lung machines.

WARNING Electric shock hazard. Do not open the device or attempt repairs. There are no user-serviceable parts inside ProBP 2400 other than battery replacement. Only perform routine cleaning and maintenance procedures specifically described in this directions for use. Inspection and servicing of internal parts shall only be performed by qualified service personnel.

WARNING The device complies with applicable domestic and international standards for electromagnetic interference and should not present problems to other equipment or be affected by other devices. As a precaution, avoid using the device in close proximity to other equipment.



WARNING Welch Allyn is not responsible for the integrity of any mounting installation. Welch Allyn recommends that customers contact their Biomedical Engineering Department or maintenance service to ensure professional installation for safety and reliability of any mounting accessory.

WARNING The device may not function properly if dropped or damaged. Do not use the device if you notice any signs of damage. Qualified service personnel must check any device that is dropped or damaged for proper operation before putting the device back into use.

WARNING Defective batteries can damage the device. If the battery shows any signs of damage, leakage, or cracking, it must be replaced immediately, and only with a battery recommended for or supplied with the device.

WARNING Improper disposal of batteries may create an explosion or contamination hazard. Never dispose of batteries in refuse containers. Do not dispose of the battery in fire. Always recycle batteries according to local regulations.

WARNING Improper handling of the battery can lead to heat generation, smoke, bursting, or fire.

WARNING Do not disassemble, modify, or solder the battery.

WARNING For proper patient electrical isolation and battery charging, use only the provided external power supply to charge the device.

WARNING Electric shock hazard. Before cleaning the device, disconnect the power cord from the power source and the device.

WARNING Take care to prevent water or other fluid from entering any connectors on the device. Should this occur, dry the connectors with warm air. Check the accuracy of all operating functions.



Avoid simultaneously connecting patients to the device and high frequency surgical equipment.



CAUTION The device is not heat-resistant. Do not autoclave.

CAUTION Use the device within stated operating temperature ranges. The device will not meet performance specifications if used outside these temperature ranges.

CAUTION Always unplug the external power source from the outlet before moving the device to a new location.

CAUTION Use only Welch Allyn approved accessories. Use of unapproved accessories with the device can affect patient and operator safety, and can reduce product performance and accuracy.

CAUTION Federal law restricts this device to sale by or on the order of a physician or licensed health care provider

NIBP (non-invasive blood pressure) warnings and cautions



WARNING ProBP 2400 is not intended to measure blood pressure on children younger than 3 years of age.

WARNING Do not compress the blood pressure hose or cuff. This may cause system errors or patient safety risks to occur.

WARNING Inaccurate measurement risk. Do not use the device on patients who are experiencing convulsions or tremors.

WARNING Use only blood pressure cuffs and hoses listed as approved accessories to ensure safe and accurate of blood pressure measurements.

WARNING Patient injury risk. When several blood pressure measurements are taken on the same patient, regularly check the cuff site and extremity for possible ischemia, purpura, and/or neuropathy.

WARNING Do not allow a blood pressure cuff to remain on the patient more than 5 minutes when inflated above 15 mmHg. Excessive cuff tightness may cause venous congestion, peripheral nerve injury, discoloration of the limb, and patient distress.

WARNING Patient injury risk. Never install Luer Lock connectors on Welch Allyn blood pressure tubing. Using these connectors on blood pressure cuff tubing creates the risk of mistakenly connecting this tubing to a patient's intravenous line and introducing air into the patient's circulatory system.

WARNING NIBP measurements may be inaccurate in the presence of excessive motion artefact. Minimize extremity and cuff motion during blood pressure readings.

WARNING The position and physiologic condition of the subject can affect a blood pressure reading.



CAUTION If the blood pressure cuff is not at heart level, note the difference in reading due to the hydrostatic effect.

CAUTION Proper blood pressure cuff size and placement is essential to the accuracy of the blood pressure determination. See Blood pressure cuff selection for sizing information.

CAUTION The blood pressure cuff must be properly positioned to ensure blood pressure accuracy and patient safety. Wrapping the cuff too loosely (preventing proper inflation) may result in inaccurate blood pressure readings.

CAUTION The patients should be comfortably seated, legs uncrossed, feet flat on the floor, back and arm supported. The middle of the cuff should be at the level of the heart.

CAUTION Recommend the patients to sit down and relax for at least 5 minutes prior to the measurement and not talk during the measurement procedure.

Product description

Name of parts

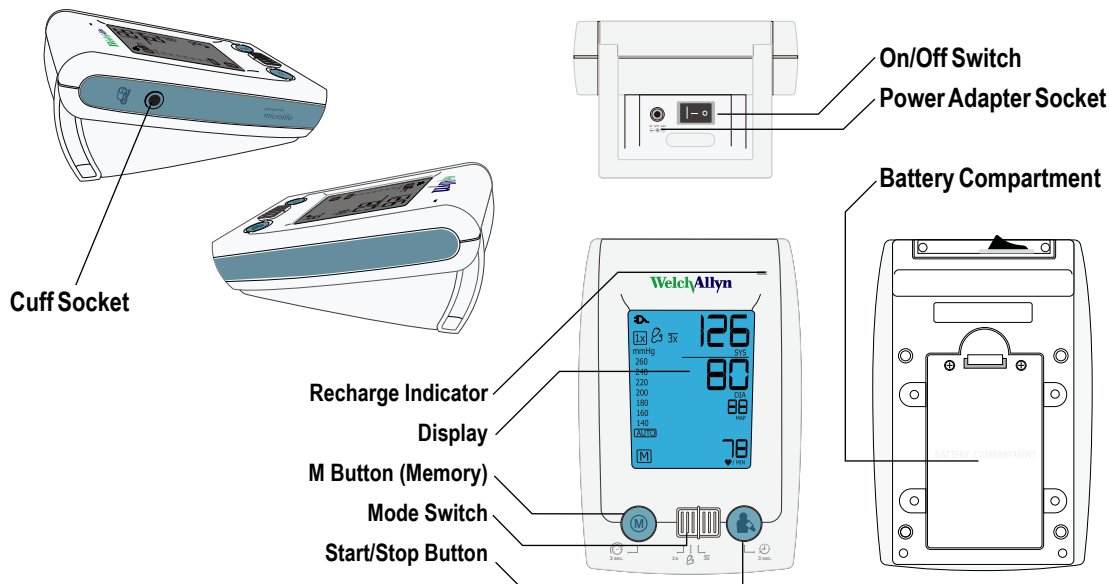

Display

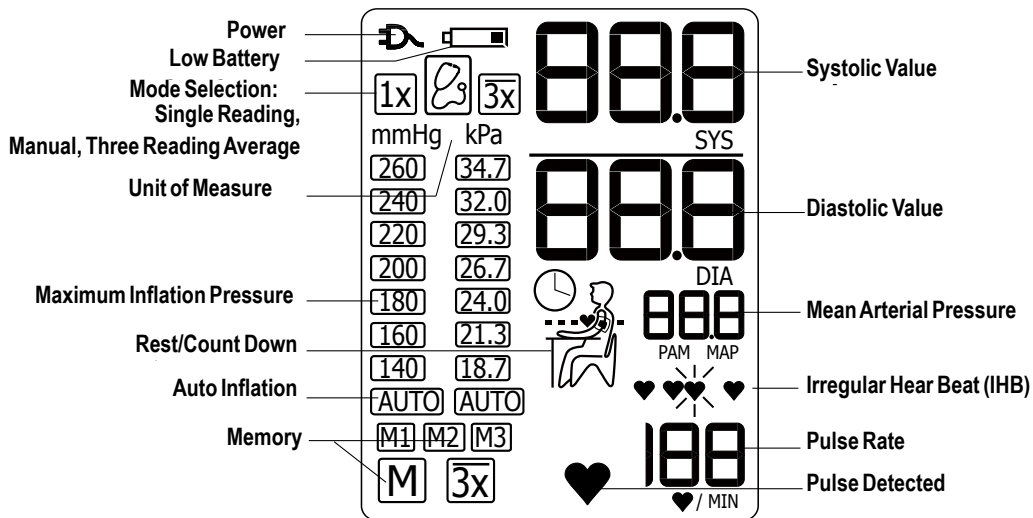

ProBP 2400 components and accessories

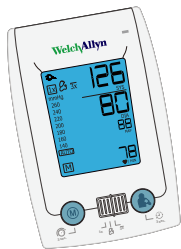

1 X ProBP 2400

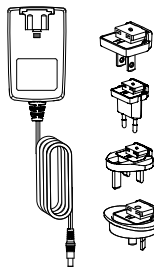

1 X Power Adapter

4 X Power Plugs (US, Europe, UK, Australia)

(Input: 100-240V~50/60Hz 0.5A
Output: +7.5V 1.5A)



1 X Adult (22cm~32cm)
1 X Large adult (32cm~42cm)



1 X CD Directions For Use

Initial set up

Attaching the power plug to the power adapter

Select a proper power plug and attach to the power adapter as shown below.

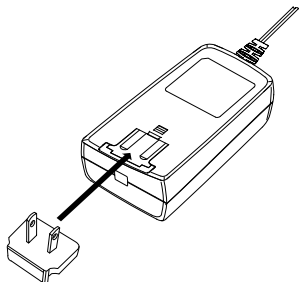

Charge the battery completely

When using for the first time, charge the battery until the recharge indicator on the device turns to green.





- ☞ Refer to page 27 for the section of “Using a power adapter”.
- ☞ Refer to page 27 for the section “Rechargeable Battery”

Initial set up (cont.)

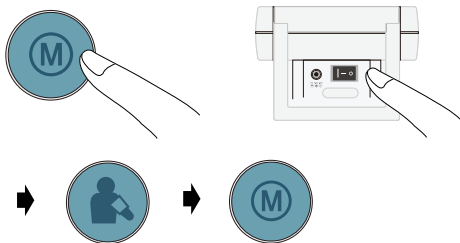
Selecting units of measure

- 1) Make sure the device is switched off.
- 2) Press and hold the M Button and then turn on the power with the On/Off Switch.
- 3) Release the M Button when backlight illuminates.
- 4) Press the Start/Stop Button to select the preferred pressure unit (mmHg or kPa).
- 5) Press M Button to confirm the selection.



		Units	MAP or PAM
1		mmHg	MAP
2		mmHg	PAM
3		kPa	MAP

 Factory default setting

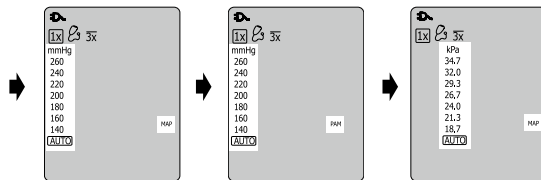

 MAP is the abbreviation of Mean Arterial Pressure.

 PAM or MAP is chosen depending on language preference.

Before using the device

Selecting the correct cuff

A variety of different cuff sizes are available. Adult and Large Adult cuffs are provided with the device. Use the cuff marker to select the cuff size that best matches the circumference of the patient's upper arm.

Cuff Size	Circumference (cm)	Circumference (inch)
Child	14 - 22	5.5 - 8.7
Adult	22 - 32	8.7 - 12.6
Large Adult	32 - 42	12.6 - 16.5
Large Adult Long	32 - 52	12.6 - 20.5

- ☞ Each cuff is provided with 130 cm air tube.
- ☞ Use only cuffs provided by Welch Allyn!
- ☞ Contact Welch Allyn or its authorized distributor to purchase cuffs.

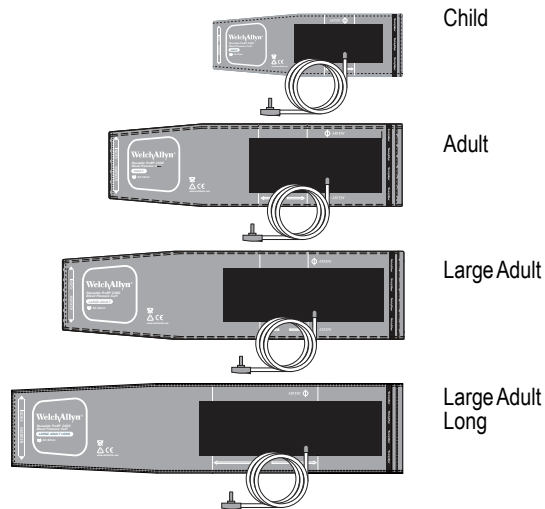

- ☞ Adult and Large Adult cuffs are included as standard accessories.

Before using the device (cont.)

Fitting the cuff properly

- 1) Place the cuff over the upper arm so that the air tube and artery mark arrow points towards the lower arm. The artery mark on the cuff must be placed over the brachial artery.
- 2) Lay the cuff on the arm. Make sure that the lower edge of the cuff lies approximately 2 to 3 cm ($\frac{3}{4}$ to 1 inch) above the elbow.

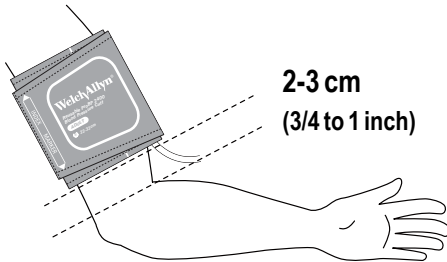

- 3) Wrap and tighten the cuff around the arm.
- 4) Leave free space with the size of 2 fingers between the arm of the patient and the cuff. Excessive tightness may cause venous congestion and discoloration of the limb. If the cuff is wrapped too loosely, it cannot be inflated properly and the measured values may be inaccurate. Remove all clothing covering or constricting the measurement arm. Clothing may interfere with measurement accuracy.

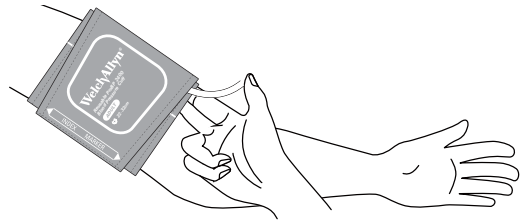

- 5) Cuffs that do not fit properly may lead to inaccurate readings. Use a different size cuff if the range index at the end of the cuff does not fall into the range specified by the range stripes.

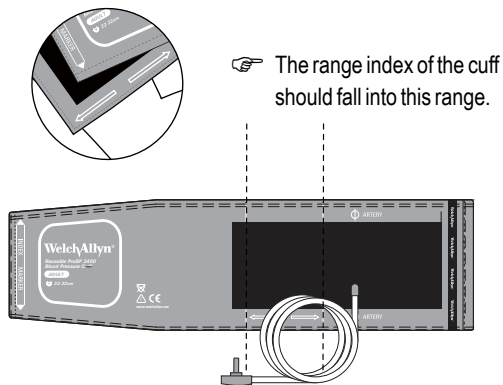

Taking measurements in 1x, Manual and 3x Mode

Turn on the power

Turn on the device by pressing the On/Off Switch at the back of the device to the ON position.

Connect the cuff to the device

Connect the cuff to the device by inserting the cuff connector into the cuff connector socket.

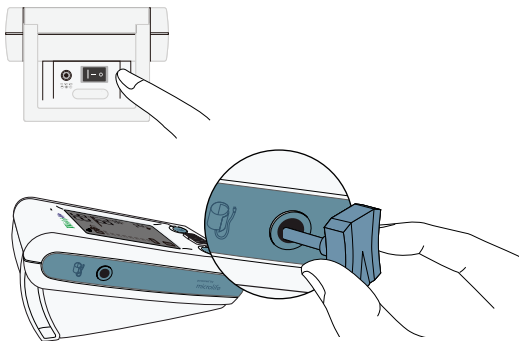

Set maximum inflation pressure

Select desired maximum inflation pressure or "AUTO".

☞ Refer to page 22 for the section of "Set maximum inflation pressure"

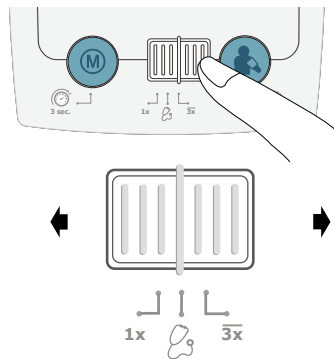

Select an operation mode

There are three measurement modes that can be used. Slide the switch to select **1x** (standard single measurement), **Manual** or **3x Mode** (automatic three reading average).

«1x» Mode (standard single measurement)

Select «1x» Mode then press the «**Start/Stop**» Button to perform a single blood pressure measurement. The measurement reading is displayed and saved after the measurement.

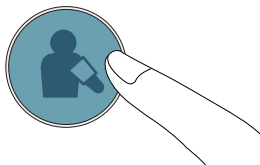
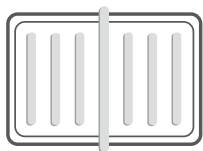

Taking measurements in 1x, Manual and 3x Mode (cont.)

«Manual» Mode

Select «Manual» Mode if auscultatory blood pressure measurement is preferred above using the oscillometric method. In «Manual» Mode, the device serves only as a pressure gauge. No oscillometric measurements will be taken. The user can hear the systolic and diastolic Korotkoff sounds by means of a stethoscope placed over the Brachial artery.

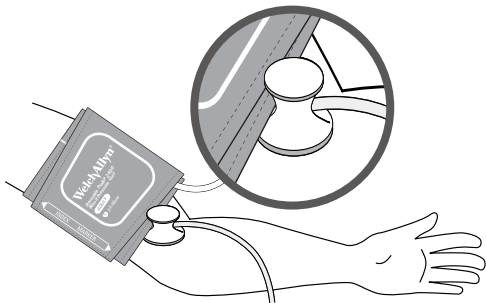

Start inflation – Press the **Start/Stop** Button to start inflation of the cuff.

When maximum inflation pressure is reached, the ProBP 2400 will automatically begin linear deflation at a rate of 3mmHg/sec.

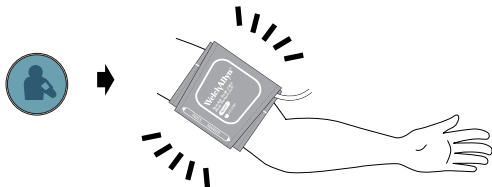

Re-inflate – Push and Hold the **M** Button during deflation to re-inflate for as long as the button is held up to a max of 299mmHg. Release the button to continue deflation. Exceeding 299mmHg will result in an immediate release of cuff pressure and a 'HI' Error message.

When the cuff pressure reaches 20mmHg during the deflation cycle, the remaining pressure is vented and the ProBP 2400 goes into the Stand by mode.

Push the **«Start/Stop»** at any time to start fast deflation and set the ProBP 2400 to Stand by.

Take note – Take note of the systolic and diastolic values in the same manner as performed with sphygmomanometer measurements.

Set to 'Stand by' – The device can be set to “Stand by” by pressing the **«Start/Stop»** Button without turning off the power. The device will automatically switch to ‘Stand by’ if there is no operation for one minute.



Stand by

«3x» Mode (automatic three reading average)

Select «3x» Mode then press the **«Start/Stop»** Button to perform automatic triple blood pressure measurements to determine a three reading average.

The countdown time before the first measurement is set at 60 seconds.

The interval times between measurements is user adjustable to 15, 30, 45 or 60 seconds. The average measurement reading is displayed and saved after the measurements are complete.

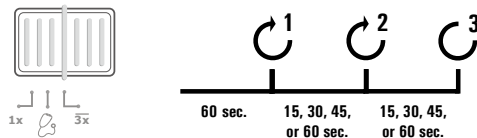



- ☞ The user can manually select up measurement interval times of 15, 30, 45 or 60 seconds in 3x Mode. (Please refer to special functions section page 21 “Setting measurement interval times”).
- ☞ The 60 second wait period before the first measurement is not adjustable but may be bypassed by pressing the Start/Stop Button a second time. This will start the first reading immediately.

Special Functions

MAP (Mean Arterial Pressure)

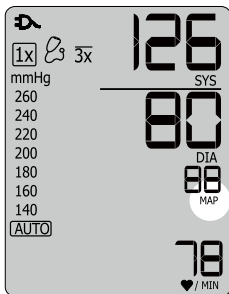
The device measures the true mean arterial pressure (MAP) of the patient. Each measurement includes a single MAP value. The MAP value will always be displayed together with the systolic and diastolic blood pressure value.



 The Mean Arterial Pressure, MAP is determined from the maximum peak of the oscillometric envelope curve.

Irregular heartbeat detector in «1x» Mode

The device detects irregular heartbeat in «1x» Mode. The irregular heartbeat symbol shows up if during a blood pressure measurement the heart rate has varied by more than 25%. In case of an irregular heartbeat the blood pressure measurement might be affected. It is recommended to repeat the measurement or to choose the «Manual» Mode for verification.

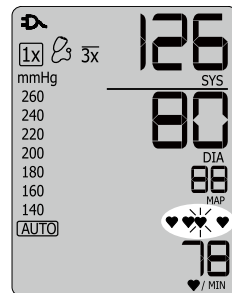

Set maximum inflation pressure

- 1) Press and hold the M Button for 3 seconds until the column with pressure values flashes.
- 2) Press the Start/Stop Button to select the preferred pressure value (after value '260' has been reached the next selection option will be "AUTO" at the bottom of the list)
- 3) Press the M Button to confirm the selected value.

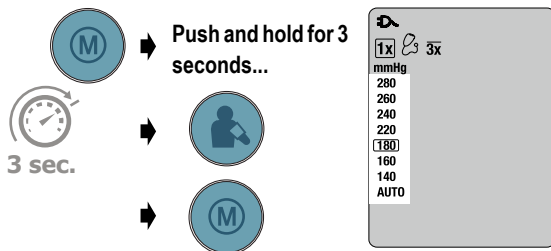

- ☞ The inflation pressure selection (mmHg/kPa) can be done in 1x, 3x, or Manual Mode. The default setting is "AUTO"
- ☞ When set to AUTO, the ProBP 2400 will automatically determine the maximum inflation pressure as it inflates the cuff.

If the maximum inflation pressure selected (or the maximum inflation pressure as determined while in AUTO mode) is not adequate to determine systolic pressure, the device will reinflate to a pressure 30 mmHg higher than the previous inflation pressure and attempt another cycle. This can be repeated increasing the maximum inflation by 30 mmHg each time. If a maximum inflation pressure of 280 mmHg is reached, and the ProBP 2400 is unable to determine a blood pressure, an error code will be displayed.

It is recommended at this point to switch to the manual mode and determine blood pressure with a stethoscope using traditional Korotkoff method. (See «Manual» Mode)

Taking fewer than three measurements in « $\overline{3x}$ » Mode

The measurement sequence can be stopped at any time during the measurement sequence by pressing the Start/Stop Button. The device enters 'Stand by' and remaining measurements are cancelled. Data from the measured blood pressure can be viewed by pushing the M Button.



Cancel remaining measurements at any time during the measurement sequence.

Skipping countdown time in « $\overline{3x}$ » Mode

The countdown before and between measurements in « $\overline{3x}$ » Mode can be skipped by pressing the Start/Stop Button. When the Start/Stop Button is pressed during countdown, the device will immediately begin the next measurement.



Skip the countdown time and begin the measurement.



The device can be set in 'Stand by' Mode by pressing the Start/Stop Button after completion of measurements. The device will automatically switch to 'Stand by' Mode if left unattended for 1 minute.



Stand by

Setting measurement interval times in «3x» Mode

The default measurement interval time is 60 seconds. The interval times can be set as 15, 30, 45 or 60 seconds.

- 1) Press and hold the Start/Stop Button for 3 seconds.



Press and hold for 3 seconds...



3 sec.

- 2) Press the M Button to adjust the measurement interval time, then press the Start/Stop Button to confirm. The device will go back to 'Stand by'.

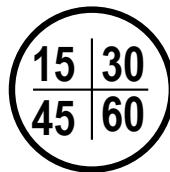

Viewing stored values

Viewing stored values

The device only stores blood pressure values of the last measurement procedure in «1x» and «3x» Mode. Press the M Button to review the stored readings when the device is in 'Stand by' mode.

1) In «1x» Mode –

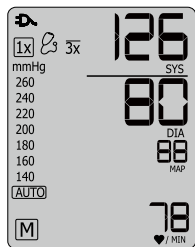
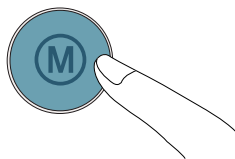

2) In «3x» Mode –

Press the M Button to reveal the average of the triple measurements. Continue pressing the M Button to review individual measurements.

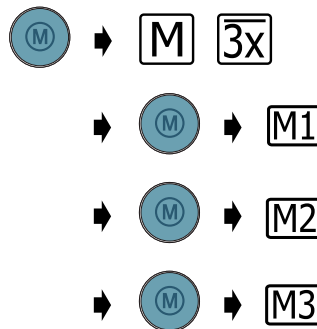

☞ The device stores only the last measurement completed in «1x» Mode and the last three measurements completed in «3x» Mode.

Rechargeable battery and power adapter

Rechargeable Battery

The ProBP 2400 features a built-in, rechargeable Ni-MH battery pack that provides up to 600~700 measurement cycles on a full charge. The battery can be recharged with the power adapter provided. The empty battery indicator is displayed when the battery is low.

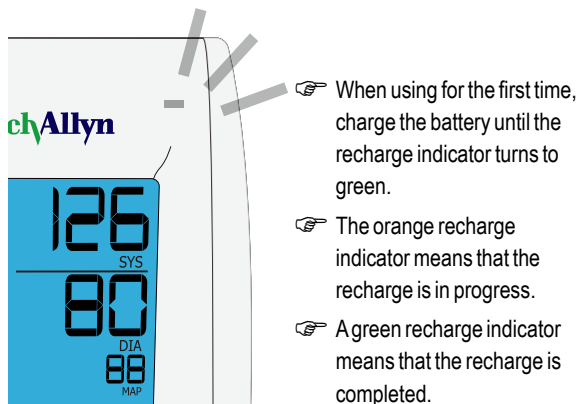

Using a power adapter

Only use the adapter supplied with ProBP 2400 to recharge the device.

- 1) Plug the adapter cable into the power socket of the device.
- 2) Plug the adapter plug into the wall socket. The battery will be recharged as long as the device is attached to an AC power source. After the battery is fully recharged, the charging will stop. No battery power will be used as long as the adapter is plugged in. The battery has to remain in the ProBP 2400 also when using the AC power.
- 3) If the battery starts losing capacity, contact your local dealer for replacement battery. The battery is user replaceable.

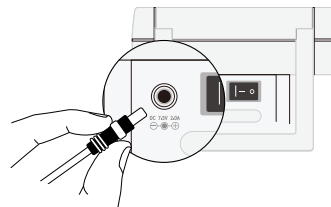

Troubleshooting

Problem	Possible cause	Solutions
No power (No LCD display)	Power supply is not properly plugged in	Plug the power supply into the wall socket.
	Battery is fully discharged	Recharge the rechargeable battery by plugging in the power supply.
Cuff does not inflate properly	Loose connection of the tube	Make sure the tube of the cuff is securely connected to the device.
	Leakage of the tube / bladder	Check for cracks on the tube or the bladder. Replace the blood pressure cuff if necessary.
No result displayed after measurements	Device is in Manual Mode	Switch to «1x» or «3x» Mode and repeat the measurements.

Error messages

If an error occurs during a measurement, the measurement is interrupted and an error message «Err» is displayed.

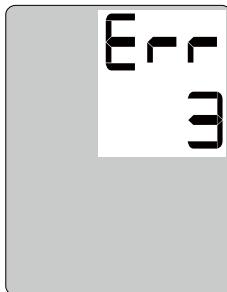
A stylized error message 'Err' displayed in a digital font. The characters are black and surrounded by several short, radiating lines, suggesting a signal or alert.

Error	Description	Potential cause and remedy
«Err 1»	Signal too weak	The pulse signals on the cuff are too weak. Reposition the cuff and repeat the measurement.
«Err 2»	Error signal	During the measurement, error signals were detected by the cuff caused, for instance, by movement or muscle tension. Repeat the measurement keeping patient's arm still.

«Err 3»	No pressure in the cuff	An adequate pressure cannot be generated in the cuff. A leak may have occurred. Replace the blood pressure cuff if necessary. Repeat the measurement.
«Err 5»	No valid results	The measuring signals are inaccurate therefore no result can be displayed. Switch to Manual Mode and determine blood pressure with a stethoscope using traditional Korotkoff method.

«HI»	Pulse rate or cuff pressure too high	The pressure in the cuff is too high (over 300 mmHg) OR the pulse is too high (over 200 beats per minute). Have the patient relax for 5 minutes and repeat the measurement.
«LO»	Pulse too low	The pulse is too low (less than 40 beats per minute). Repeat the measurement.

Safety, care, accuracy test and disposal

Safety and protection

This device may be used only for the purpose described in this directions for use manual. The device comprises of sensitive components and must be treated with care. The manufacturer cannot be held liable for damage caused by incorrect application.



- Only activate the pump when the cuff is connected to the device.
- Do not use the device if you think it is damaged or if anything appears unusual.
- Read further safety instructions in the individual sections of the instruction manual.

Observe the storage and operating conditions described in the “Technical specifications” section of this directions for use manual.



Protect the device from water and moisture



Protect the device from direct sunlight



Protect the device from extreme heat and cold



Avoid proximity to electromagnetic fields, such as those produced by mobile phones



Never open device



Protect device from impact and drops

Device care

Use a soft cloth with one of the following recommended cleaning solutions to wipe the exterior of the device:

- 1) Mild soap and water
- 2) Hydrogen peroxide solution (3% diluted with water)
- 3) Sodium hypochlorite solution (1:10 dilution of household chloride bleach in water)

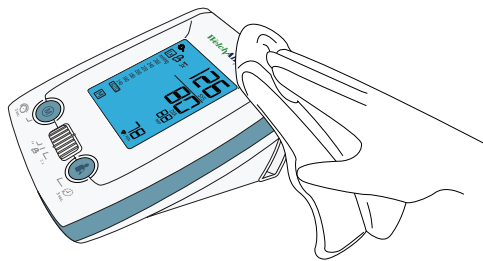

Cleaning the cuff

Remove the bladder. Fold and place the cuff cover inside a washing bag. Wash the cuff cover with warm water (43°C; 110°F) and a mild detergent in the washing machine.

Pasteurization: wash the cuff cover in 75°C (167°F) hot water for 30 minutes.

Air dry the cuff. **DO NOT** iron the cuff cover

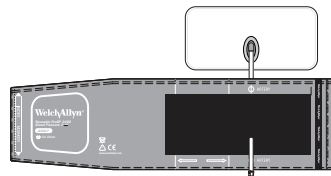

Do not iron the cuff!

Transducer accuracy test (Calibration Verification)

We recommend the device to be tested for accuracy every 2 years or after mechanical impact (e.g. been dropped).

- 1) Setup for accuracy test
- 2) Push and hold “Start/Stop” Button and turn the power on then release the “Start/Stop” Button. Wait until “CA 0”, then “0 0” is displayed.

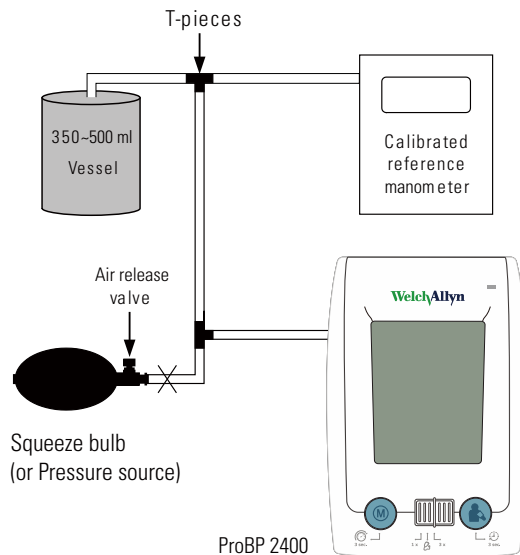
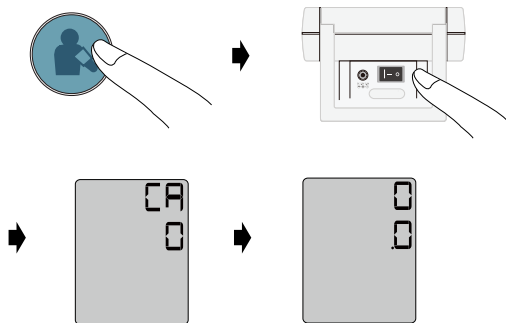

- 3) Pump the pressure to nearly 100mmHg. Compare the pressure displayed on the screens of the device and the reference manometer. For example, the “100 .9” displayed on the device stands for “100.9 mmHg”.
- 4) Pump the pressure to nearly 200mmHg. Compare the pressure displayed on the screens of the device and the reference manometer. For example, the “201.0” displayed on the device stands for “201.0 mmHg”.
- 5) Pump the pressure to nearly 300mmHg. Compare the pressure displayed on the screens of the device and the reference manometer. For example, the “301.2” displayed on the device stands for “301.2 mmHg”.
- 6) If the difference between the device and the reference manometer at any calibration point exceeds $\pm 3\text{mmHg}$ plus the stated accuracy of the reference manometer, you may contact Welch Allyn to obtain calibration service.

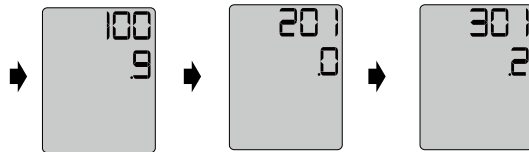

Disposal



Batteries and electronic instruments must be disposed of in accordance with the locally applicable regulations, and not as domestic waste.

Technical specifications

Operation temperature/humidity:	10 to 40 °C (50 to 104 °F) 15 - 90 % relative maximum humidity
Storage temperature/humidity:	-20 to 55 °C (-4 to 131 °F) 15 - 90 % relative maximum humidity
Weight:	800 g (including rechargeable battery pack)
Dimensions:	200 x 125 x 90 mm
Measuring method:	Oscillometric, Systolic blood pressure = K1 Diastolic blood pressure = K5
Measurement range:	60 - 255mmHg - systolic blood pressure 30 - 200mmHg - diastolic blood pressure 40 - 200 beats per minute - pulse
Cuff pressure display:	Range: 0 - 299 mmHg Resolution: 1 mmHg Static accuracy: pressure within ± 3 mmHg Pulse accuracy: ± 5 % of the readout value
Power source:	Rechargeable battery pack; 4.8V 2400 mAh (optional 4.8V 3500mAh) Mains power supply DC 7.5V, 1.5A

Welch Allyn reserves the right to alter technical specifications without prior written notice.

Reference to Standards: Device corresponds to the requirements of the standard for non-invasive blood pressure monitor.
IEC 60601-1:2005+A1:2012
IEC 60601-1-2:2014
ANSI/AAMI/ISO 81060-2
AAMI / ANSI / IEC 80601-2-30

Electromagnetic

Compatibility:

CE 0044

Device fulfills the stipulations of the standard IEC 60601-1-2.

The stipulations of the EU Directive 93/42/EEC for Medical Devices Class IIa have been fulfilled.



Type BF applied part



Microlife AG
Esenstrasse 139
9443 Widnau, Switzerland



Microlife Corporation
9F, 431, RuiGuang Road, NeiHu,
Taipei, 11492, Taiwan, R.O.C.

ETL CLASSIFIED



Intertek
5000497

CONFORMS TO AAMI STD ES 60601-1, IEC STD. 60601-1-6, IEC STD. 80601-2-30

CERTIFIED TO CSA STD C22.2 NO. 60601-1, NO. 60601-1-6, NO. 80601-2-30

WARRANTY

Welch Allyn will warranty the ProBP 2400 device to be free of defects in material and workmanship and to perform in accordance with manufacturer specifications for a period of two years from the date of purchase from Welch Allyn or its authorized distributors or agents. Accessories are covered for a period of one year from date of purchase from Welch Allyn or its authorized distributors or agents.

The warranty period shall start on the date of purchase. The date of purchase is: 1) the invoiced ship date if the device was purchased directly from Welch Allyn, 2) the date specified during product registration, 3) the date of purchase of the product from a Welch Allyn authorized distributor as documented from a receipt from said distributor.

This warranty does not cover damage caused by: 1) handling during shipping, 2) use or maintenance contrary to labeled instructions, 3) alteration or repair by anyone not authorized by Welch Allyn, and 4) accidents.

The product warranty is also subject to the following terms and limitations:

Shipping cost to return a device to a Welch Allyn Service center is not included.

A service notification number must be obtained from Welch Allyn prior to returning any products or accessories to Welch Allyn's designated service centers for repair. To obtain a service notification number, contact Welch Allyn Technical Support.

THIS WARRANTY IS IN LIEU OF ALL OTHER WARRANTIES, EXPRESS OR IMPLIED, INCLUDING BUT NOT LIMITED TO THE IMPLIED WARRANTIES OF MERCHANTABILITY AND FITNESS FOR A PARTICULAR PURPOSE. WELCH ALLYN'S OBLIGATION UNDER THIS WARRANTY IS LIMITED TO REPAIR OR REPLACEMENT OF PRODUCTS CONTAINING A DEFECT. WELCH ALLYN IS NOT RESPONSIBLE FOR ANY INDIRECT OR CONSEQUENTIAL DAMAGES RESULTING FROM A PRODUCT DEFECT COVERED BY THE WARRANTY.

©2014 Welch Allyn. All rights are reserved. To support the intended use of the product described in this publication, the purchaser of the product is permitted to copy this publication, for internal distribution only, from the media provided by Welch Allyn. No other use, reproduction, or distribution of this publication, or any part of it, is permitted without written permission from Welch Allyn.

For the addresses and phone numbers of all Welch Allyn regional locations, visit: welchallyn.com/locations.