

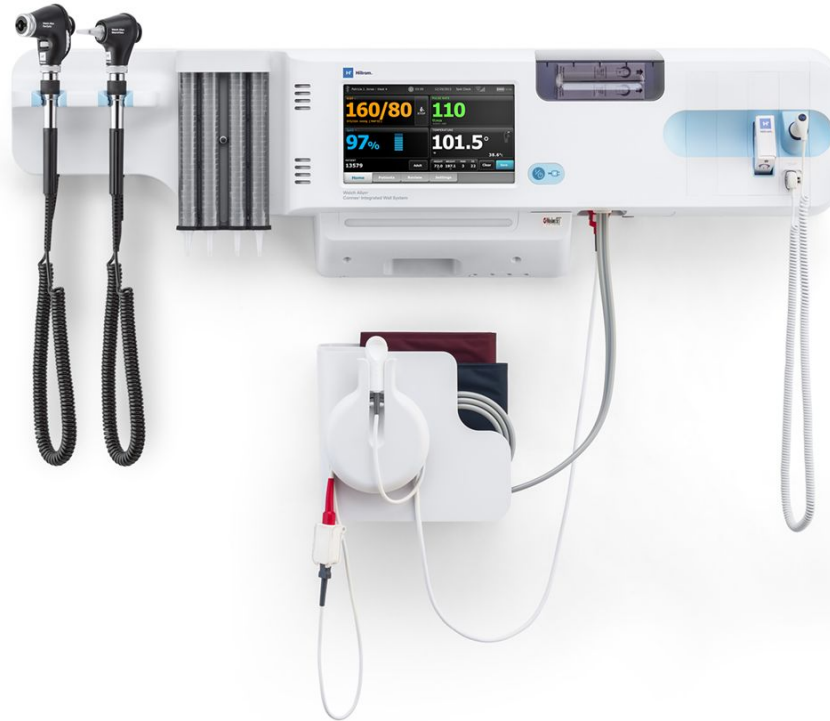

Hillrom™

Welch Allyn Connex® Integrated Wall System



Service manual

Software versions 2.3X–2.4X

© 2021 Welch Allyn. All rights are reserved. The purchaser of the product is permitted to copy this publication, for internal distribution only, from the media provided by Welch Allyn. No other use, reproduction, or distribution of this publication, or any part of it, is permitted without written permission from Welch Allyn.

Legal Statement. Welch Allyn, Inc. (“Welch Allyn”) assumes no responsibility for any injury to anyone that may result from (i) failure to properly use the product in accordance with the instructions, cautions, warnings, or statement of intended use published in this manual, or (ii) any illegal or improper use of the product.

Welch Allyn, Connex, SureTemp, FlexiPort, and SureBP are registered trademarks of Welch Allyn.

PartnerConnect is a trademark of Welch Allyn.

Integrated Pulmonary Index and Oridion and Microstream are trademarks of a Medtronic company. No implied license. Possession or purchase of this device does not convey any express or implied license to use the device with unauthorized CO2 sampling products which would, alone, or in combination with this device, fall within the scope of one or more of the patents relating to this device and/or CO2 sampling products.

Radical-7R, Pulse CO-Oximeter, rainbow Acoustic Monitoring, RRa, and ReSposable are trademarks of, and SET, LNCS, SpHb, rainbow, and Masimo are registered trademarks of Masimo Corporation. Possession or purchase of a Masimo-equipped device does not convey any express or implied license to use the device with unauthorized sensors or cables which would, alone or in combination with this device, fall within the scope of one or more of the patents relating to this device. For Masimo patent information, please visit www.masimo.com/patents.htm.

Nellcor SpO2 Patient Monitoring System with OxiMax Technology and Nellcor SpO2 OxiMax Technology are trademarks of a Medtronic company. For Nellcor patent information, please visit www.medtronic.com/patents.

Braun and ThermoScan are registered trademarks of Braun GmbH.

Bluetooth is a registered trademark of Bluetooth SIG.

Welch Allyn has provided Clinical Dynamics of CT, LLC, the calibration tables (CALTables) for use in its AccuPulse and AccuSim NIBP Simulators. For more information, [click this link](#).

Software in this product is Copyright 2021 Welch Allyn or its vendors. All rights are reserved. The software is protected by United States of America copyright laws and international treaty provisions applicable worldwide. Under such laws, the licensee is entitled to use the copy of the software incorporated with this instrument as intended in the operation of the product in which it is embedded. The software may not be copied, decompiled, reverse-engineered, disassembled, or otherwise reduced to human-perceivable form. This is not a sale of the software or any copy of the software; all right, title, and ownership of the software remain with Welch Allyn or its vendors.

This product may contain software known as “free” or “open source” software (FOSS). Hill-Rom uses and supports the use of FOSS. We believe that FOSS makes our products more robust and secure, and gives us and our customers greater flexibility. To learn more about FOSS that may be used in this product, please visit our FOSS website at hillrom.com/opensource. Where required, a copy of FOSS source code is available on our FOSS website.

PATENTS / PATENT hillrom.com/patents

May be covered by one or more patents. See above Internet address. The Hillrom companies are the proprietors of European, US, and other patents and pending patent applications.

For information about any product, contact Hillrom Technical Support: <https://hillrom.com/en-us/about-us/locations>.

REF 80026030 Ver. A



Welch Allyn, Inc.
4341 State Street Road
Skaneateles Falls, NY 13153 USA

Revision date: 2021-10

Welch Allyn, Inc. is a subsidiary of Hill-Rom Holdings, Inc.

hillrom.com



Contents



Symbols	1
Safety	5
Warnings and cautions	5
General safety considerations	6
Electrostatic discharge (ESD)	6
Overview	9
Purpose and scope	9
Technical support services	10
Recommended service intervals	13
The Welch Allyn Service Tool	14
Battery performance	16
Controls, indicators, and connectors	19
Service menu	23
Advanced settings and Service tabs	23
Access the Service tabs	23
General tab	24
Self-tests tab	27
Logs tab	28
Device tab	28
Licensing tab	28
Password tab	29
Power-up sequence	31
Troubleshooting	33
Symptoms and solutions	33
Technical alarm messages	47
Disassembly and repair	65
Required tools and equipment	67
Disassembly overview	68
Section A	69
Power down the device	69
Exploded view, front exterior	71
Exploded view, rear interior	78

Section B	109
Power down the device	110
Exploded view, front exterior	111
Exploded view, rear interior	118
Functional verification and calibration	151
Functional verification tests	151
Basic functional verification checks	154
Electrical safety testing	169
Ground stud connector	170
Options, upgrades, and licenses	171
Available options, upgrades, and licenses	172
Install options	174
Host firmware requirements	176
Masimo parameter upgrades	177
Configure options	177
Chinese fonts and input method editor (IME) tables	177
Field replaceable units	179
Table for service kits	179
Licenses	183
SmartCare services for maintenance and repair	184
Service and repair training	185
Service tools	185
Appendix	187
Decontamination and cleaning requirements for returns	187
Configuration options	189
Factory defaults	190
Disassembly and repair reference	207
Connex Integrated Wall System interconnect diagram	216
Service and maintenance toolset	218
Connex Direct	221
Introduction	221
Active Directory setup	225
Project workflow	245
Troubleshooting	246
Service record	253





Symbols

For information on the origin of these symbols, see the Welch Allyn symbols glossary: <https://www.hillrom.com/content/dam/hillrom-aem/us/en/sap-documents/LIT/80022/80022945LITPDF.pdf>.









Documentation symbols

	<p>WARNING The warning statements in this manual identify conditions or practices that could lead to illness, injury, or death.</p>
	<p>CAUTION The caution statements in this manual identify conditions or practices that could result in damage to the equipment or other property, or loss of data. This definition applies to both yellow and black and white symbols.</p>
	<p>Follow the operating instructions/directions for use (IFU) — mandatory action. A copy of the IFU is available on this website. A printed copy of the IFU can be ordered from Welch Allyn for delivery within 7 days.</p>







Power symbols

			<p>Equipotential terminal</p>
			
	<p>(on the display) monitor is plugged into Alternating Current power</p>		<p>Battery absent or faulty</p>





2 Symbols

	(on the monitor, green indicator) Alternating Current power present, battery fully charged		Battery charge level
	(on the monitor, amber indicator) Alternating Current power present, battery is charging		Battery cover
	Alternating Current (AC)		Rechargeable battery
	Rated power input, DC		Rated power input, AC
	Direct current (DC)		

Connectivity symbols

	USB		Ethernet RJ-45
	Wireless signal strength <ul style="list-style-type: none"> • Best (4 bars) • Good (3 bars) • Fair (2 bars) • Weak (1 bar) • No signal (no bars) • No connection (blank) 		Nurse call [recent models]
			Nurse call [older models]
	Connected to central station		Disconnected from central station

Miscellaneous symbols

	Product Identifier		Serial number
	Do not reuse		China RoHS markings for control of pollution caused by electronic information products. XX indicates Environmentally Friendly Use Period in years.

	Nonionizing electromagnetic radiation		Recycle the product separate from other disposables
	Restrictions for use of wireless device in Europe. European Community's Class 2 radio equipment.		Call for maintenance
	Defibrillation-proof Type BF applied parts		Defibrillation-proof Type CF applied parts
	Atmospheric pressure limitation		Not for injection
	Transport and storage temperature range		Humidity limitation
	Maximum safe working load limits (specific values presented with symbol)		Mass in kilograms (kg)
	Recycle	IPX0	IP = International Protection Marking X = No object ingress rating 0 = Degree of protection provided by the enclosure with respect to harmful ingress of liquids
	Do not expose to open flame		Keep dry
	Reorder number		Global Trade Item Number
R_x ONLY	Prescription only or "For Use by or on the order of a licensed medical professional"		Manufacturer
	FCC logo		Stacking limit by number

4 Symbols



KC mark



Australian Communications and
Media Authority (ACMA) Radio
Compliance Mark (RCM)

Safety

All users of the system must read and understand all safety information presented in this manual before using or repairing the system.

United States federal law restricts this device to sale, distribution, or use by or on the order of a licensed medical practitioner.

Warnings and cautions



WARNING Safety risk. Make frequent electrical and visual checks on cables, sensors, and electrode wires. All cables, sensors, and electrode wires must be inspected and properly maintained and in proper working order to allow the equipment to function properly and to protect patients.



WARNING Safety risk. Place the system and accessories in locations where they cannot harm the patient should they fall from a shelf or mount.



WARNING Fire and explosion hazard. Do not operate the system in the presence of a flammable anesthetic mixture with air, oxygen, or nitrous oxide; in oxygen-enriched environments; or in any other potentially explosive environment.



WARNING Inaccurate measurement risk. Dust and particle ingress can affect the accuracy of blood pressure measurements. Use the system in clean environments to ensure measurement accuracy. If you notice dust or lint build-up on the system's vent openings, have the system inspected and cleaned by a qualified service technician.



WARNING Defective batteries can damage the device. If the battery shows any signs of damage or cracking, replace it immediately, and only with a battery approved by Welch Allyn.



CAUTION Before disassembling the device or installing options, disconnect the patient from the system, power down the device, and disconnect the AC power and any attached accessories (for example, SpO2 sensors, blood pressure hoses and cuffs, and temperature probes) from the device.



CAUTION To ensure that the system meets its performance specifications, store and use the system in an environment that maintains the specified temperature and humidity ranges.



CAUTION The system may not function properly if dropped or damaged. Protect it from severe impact and shock. Do not use the system if you notice any signs of damage.



CAUTION Do not connect more than one patient to a system or connect more than one system to a patient.



CAUTION Do not operate the system in the presence of magnetic resonance imaging (MRI) or hyperbaric chambers.



CAUTION Do not autoclave the system. Autoclave accessories only if the manufacturer's instructions clearly approve it.

General safety considerations

- If the monitor detects an unrecoverable problem, it displays an error message. For more information see "Troubleshooting."
- To ensure patient safety, use only accessories recommended or supplied by Welch Allyn. (See the accessories list in the user documentation or <https://parts.hillrom.com/hillromUS/en/>.) Always use accessories according to your facility's standards and according to the manufacturer's recommendations and instructions. Always follow the manufacturer's instructions for use.
- Welch Allyn recommends that only Welch Allyn service personnel or an authorized repair center perform warranty service. Performing unauthorized service on a device that is within warranty may void the warranty.

Electrostatic discharge (ESD)



CAUTION Electrostatic discharge (ESD) can damage or destroy electronic components. Handle static-sensitive components only at static-safe workstation.



CAUTION Assume that all electrical and electronic components of the monitor are static-sensitive.

Electrostatic discharge is a sudden current flowing from a charged object to another object or to ground. Electrostatic charges can accumulate on common items such as foam drinking cups, cellophane tape, synthetic clothing, untreated foam packaging material, and untreated plastic bags and work folders, to name only a few.

Electronic components and assemblies, if not properly protected against ESD, can be permanently damaged or destroyed when near or in contact with electrostatically charged objects. When you handle components or assemblies that are not in protective bags and you are not sure whether they are static-sensitive, assume that they are static-sensitive and handle them accordingly.

- Perform all service procedures in a static-protected environment. Always use techniques and equipment designed to protect personnel and equipment from electrostatic discharge.

- Remove static-sensitive components and assemblies from their static-shielding bags only at static-safe workstations—a properly grounded table and grounded floor mat—and only when you are wearing a grounded wrist strap (with a resistor of at least 1 megohm in series) or other grounding device.
- Use only grounded tools when inserting, adjusting, or removing static-sensitive components and assemblies.
- Remove or insert static-sensitive components and assemblies only with monitor power turned off.
- Insert and seal static-sensitive components and assemblies into their original static-shielding bags before removing them from static-protected areas.
- Always test your ground strap, bench mat, conductive work surface, and ground cord before removing components and assemblies from their protective bags and before beginning any disassembly or assembly procedures.

Overview

Purpose and scope

This manual is a reference for periodic preventive maintenance and corrective service procedures for the Welch Allyn Connex Integrated Wall System, firmware version 2.3X-2.4X. It is intended for use only by trained and qualified service personnel.

Corrective service is supported to the level of field-replaceable units. These include circuit-board assemblies and some subassemblies, case parts, and other parts.



CAUTION No component-level repair of circuit boards and subassemblies is supported. Use only the repair procedures described in this manual.



WARNING When performing a service procedure, follow the instructions exactly as presented in this manual. Failure to do so could damage the device, invalidate the product warranty, and cause serious personal injury.

Find instructions for functional testing and performance verification in the Welch Allyn Service Tool help files.

This manual applies only to this device. For servicing of any other device, see the service manual for the specific device.

Service work not described in this manual must be performed by qualified service personnel at the factory or at an authorized Welch Allyn service center.

Related documents

When using this manual, refer to the following:

- *Welch Allyn Connex® Devices Instructions for use, Software version 2.4X*
- Welch Allyn Service Tool
<https://www.hillrom.com/en/services/welch-allyn-service-tool/>
- *Welch Allyn Service Tool Installation and configuration guide*
<https://www.hillrom.com/en/services/welch-allyn-service-tool/>
- *Welch Allyn Braun ThermoScan® PRO 6000 Ear Thermometer, Service manual*
[click here to download the PDF](#)
- *Welch Allyn 9600 Plus Calibration Tester Directions for use* [click here to download the PDF](#)
- Hillrom website: hillrom.com

Technical support services

Welch Allyn offers the following technical support services:

- Telephone support
- Loaner equipment
- Service agreements
- Service training
- Replacement service parts
- Product service

For information on any of these services, contact Hillrom Technical Support: hillrom.com/en-us/about-us/locations/.

Service loaners

For warranty or non-warranty repairs not covered under a support agreement, loaners are available for a nominal charge, subject to availability. Payment is required prior to shipment for all loaners not covered under a support agreement.

Welch Allyn Service Centers that provide repair service for this product can, on request, loan a device for use while the device is being repaired. Loaned devices are provided free of charge for products repaired while under a support agreement that includes a free loaner provision.

Loaner equipment for the individual component modules is not available.

Service options

SmartCare™ services for maintenance and repair

While product warranties provide basic assurance of Welch Allyn hardware quality, they may not include the full range of services and support you need. Welch Allyn offers premium service and support through our SmartCare program. Whether you service your own devices and require a minimum of support or rely on us to service your device, Welch Allyn provides a program that will meet your needs. A list of available service and support agreements is presented in the "Field replaceable units" section of this manual.

For more information, call your sales representative or visit our website:

<https://www.hillrom.com/en/services/>.

SmartCare Remote Management

SmartCare Remote Management is a secure cloud-based portal that offers biomed access to manage their Hillrom connected devices remotely in a centralized portal.

For more information and a complete list of compatibility information, refer to the SmartCare Remote Management Instructions for use.

Warranty service

All repairs on products under warranty must be performed or approved by Welch Allyn. Refer all warranty service to Welch Allyn Product Service or another authorized Welch Allyn Service Center.

Obtain a Return Material Authorization (RMA) number for all returns to Welch Allyn Product Service from our website:

<http://www.welchallyn.com/en/service-support/submit-a-repair.html>.



CAUTION Unauthorized repairs will void the product warranty.

Non-warranty service

Welch Allyn product service and authorized service centers support non-warranty repairs. Contact any Welch Allyn regional service center for pricing and service options.

Welch Allyn offers modular repair parts for sale to support non-warranty service. This service must be performed only by qualified end-user biomedical/clinical engineers using this service manual.

Service training is available from Welch Allyn for biomedical/clinical engineers. Follow this [link](#) for more information.

Repairs

A Welch Allyn Service Center must perform all repairs on products under warranty, unless you have purchased a Welch Allyn Partners in Care Biomed agreement allowing you to service the device while under warranty.



CAUTION Unauthorized repairs will void the product warranty.

Qualified service personnel or a Welch Allyn Service Center should repair products out of warranty.

If you are advised to return a product to Welch Allyn for repair or routine maintenance, schedule the repair with the service center nearest you.

Welch Allyn Technical Support

If you have a problem with the device that you cannot resolve, call the Welch Allyn Technical Support Center nearest you for assistance. A representative will assist you in troubleshooting the problem and will make every effort to solve the problem over the phone, potentially avoiding an unnecessary return.

To expedite response to your issue, be prepared to provide details on how (steps executed) and when (time and date) the problem occurred. Also, log and configuration files captured on the device can assist with diagnosis and troubleshooting. You can easily save these files from the device to a flash drive using controls on the Service tab. See the "Service menu" section of this manual for details.

If your product requires warranty, extended warranty, or non-warranty repair service, a Welch Allyn Technical Support representative will record all necessary information to issue an RMA number. The support representative will provide you with the address of the Welch Allyn Service Center to send your device to.

Technical support is available during local business hours.

Returning products

When returning a product to Welch Allyn for service, ensure that you have the following information:

- Product name, model number, and serial number. This information may be found on the product and serial number labels on the bottom of the device.

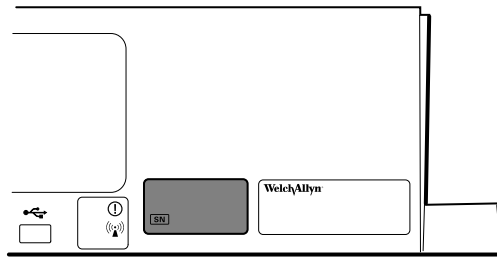

- A complete return shipping address.
 - A contact name and phone number.
 - Any special shipping instructions.
 - A purchase order number or credit card number if the product is not covered by a warranty.
 - A SmartCare contract number if product is covered under a service agreement.
 - A full description of the problem or service request.
1. Obtain an RMA number:
 - Visit us on the web at <https://www.welchallyn.com/en/service-support/submit-a-repair/>, or
 - Contact Welch Allyn to make a request.



NOTE Welch Allyn does not accept returned products without an RMA.

2. Ship the device to Welch Allyn, observing these rules:
 - a. Remove from the package the battery, all hoses, connectors, cables, sensors, power cords, and other ancillary products and equipment, except those items that might be associated with the problem.
 - b. Follow shipping and handling requirements regarding Lithium-ion batteries to comply with new IATA regulations.

Requirements for returning Lithium-ion batteries

- Remove the Lithium-ion battery from the device. You cannot ship these devices with batteries installed.
- Follow packaging requirements (presented next in this section).
- Do not ship any battery that has been physically damaged or shows signs of leakage.
- Do not ship any battery that has been recalled by the supplier or manufacturer.
- Do not ship any waste batteries that should be recycled or discarded.
- Do not ship multiple batteries together.
- Use ground transportation only to ship Lithium-ion batteries.

Packaging requirements for Lithium-ion batteries and associated devices

- Use packaging provided by Welch Allyn or the battery manufacturer to pack the battery. Seal the battery in the anti-static bag and place it in the shipping box. Return shipments without approved packing materials will not be accepted.



NOTE If the original shipping carton or replacement battery shipping box is unavailable, consult the manufacturer website for information regarding shipping Lithium-ion batteries:

<http://www.iata.org/lithiumbatteries>

- If returning both the battery and the device, pack the battery and the device separately.
 - If returning multiple batteries, pack and ship each battery individually. Do not consolidate multiple batteries in a single package.
- c. Clean the device.



NOTE To ensure safe receipt of your device by the service center and to expedite processing and return of the device to you, **thoroughly clean all residues from the device before you ship it to Welch Allyn.** For decontamination and cleaning requirements, see the appendices.

If a returned device is found to be contaminated with bodily fluids, it will be returned at the owner's expense. United States federal regulations prohibit the processing of any device contaminated with blood-borne pathogens. Welch Allyn thoroughly cleans all returned devices on receipt, but any device that cannot be adequately cleaned cannot be repaired.

- d. Pack the device. Put the device, enclosed in a plastic bag **with a packing list**, into the original shipping carton with the original packing materials or into another appropriate shipping carton, and seal appropriately for shipping. Remember that batteries must be removed from devices before packing and shipping them for return.
- e. Write the Welch Allyn RMA number with the Welch Allyn address on the outside of the shipping carton.



WARNING Safety risk. Do not ship any battery that has been physically damaged or shows signs of leakage unless you receive specific instructions which meet the requirements for the shipment of Lithium batteries. Dispose of damaged or leaking batteries in an environmentally safe manner consistent with local regulations.



WARNING Safety risk. Do not pack a defective battery in checked or carry-on baggage if traveling by air.



NOTE In the United States, the applicable regulations can be found in the Code of Federal Regulations (CFR). Refer to 49 CFR 173.185 for shipping lithium batteries by air or ground. Use 49 CFR 172.102 sections 29, 188, 189, A54, A55, A100, A101, A103, and A104 to find the special provisions for shipping lithium batteries.

Recommended service intervals

To confirm that the device is functioning within the design specifications, perform periodic service as indicated in the following table. Customers who have the Standard unlicensed edition of the Welch Allyn Service Tool can perform the basic functional verification and calibration procedures referenced in the table by following the instructions in this manual. If you have the Gold licensed

edition of the service tool, use the tool to perform a complete functional verification and calibration of the device in lieu of performing the basic tests.

Component	Service interval	Service procedure
NIBP module	Annually	Basic functional verification
SpO2 module	Annually	Basic functional verification
SpHb parameter	Annually	Basic functional verification
SureTemp Plus	Annually	Basic functional verification
ECG	N/A	N/A
Braun ThermoScan PRO 6000	Annually	Basic functional verification
Battery	300 charge cycles	Replace the battery
Housing	Annually	Clean air vents to prevent dust buildup

Use the service tool, Gold licensed edition, to perform a complete functional verification and calibration of the device whenever any of the following conditions exist:

- Based on the basic functional verification, the device does not meet specifications
- The device has been dropped or otherwise damaged
- The device is malfunctioning
- The case has been opened
- An internal part has been replaced (battery excluded)



NOTE For instructions on using the Gold licensed edition, see the service tool help files.

Maintenance

For device maintenance information, see “Maintenance and service” in the device’s instructions for use. Covered topics include the following:

- Inspecting and cleaning the device and accessories
- Changing the battery

The Welch Allyn Service Tool

The Welch Allyn Service Tool is available in the following editions:

- **Standard unlicensed:** Accompanies your device. Download from <https://www.hillrom.com/en/services/welch-allyn-service-tool/>.
- **Gold:** Required to perform complete functional verification and calibration. This edition requires an additional license. For more information about acquiring this license, contact Welch Allyn.



NOTE To qualify for the Gold license, you must attend the Welch Allyn technical training course or complete online training for the device.

Clinicians and technical service personnel can use the service tool to manage and maintain supported Welch Allyn products. You can use the service tool to do the following:

- **Review device information.** When connected to the device, the service tool lists installed modules, installed firmware and hardware versions, warranty and repair information, status, and usage history.
- **Receive notifications when periodic maintenance is needed.** The service tool can help you manage and maintain your entire inventory of supported Welch Allyn products. Through the remote service function, the service tool can connect to Welch Allyn Customer Service. With this functionality you can automatically receive firmware updates and feature upgrades for your supported products, including software upgrades for the service tool.
- **Install updates and upgrades.** The service tool can read the firmware version for each module and check for available updates or upgrades.



NOTE For the Welch Allyn Service Tool to support updates and upgrades, adjust your firewall settings to permit access for IP address 169.254.10.10 (the local feed server for the software upgrade process).

- **Create a work list.** The work list provides information about service actions—referred to as work orders—that are waiting for you to perform on your maintained devices. Work orders may include periodic calibrations, upgrades, or license installations.
- **Schedule periodic maintenance.** You can use the service tool to set the service interval for each maintained device.
- **View and save logs.** You can download and save log files from the device for analysis to help diagnose and identify reported issues.
- **Create user accounts.** Administrators can create user accounts and set permission levels to control access to the features, allowing one group to perform administrative tasks and another to perform service tasks. Restricting access prevents the service tool from being used to make unauthorized changes on a connected device.
- **Perform functional verification and calibration.** The service tool can check any device requiring calibration and, if necessary, calibrate the device to match the design specifications. This feature is not supported for all products and requires the service tool, Gold edition, for each supported product.
- **Recover devices.** In the rare case where a device can no longer boot because of corrupted firmware, the service tool can connect the device to Welch Allyn Technical Support to reinstall the firmware.
- **Extensible.** The service tool software accepts new plug-ins to support future Welch Allyn products.

Some of these features are enabled for any user (Standard unlicensed edition). Others require special user account privileges or a Welch Allyn service contract (Gold edition). If you require gold-level support for a Welch Allyn product, please contact Welch Allyn technical support.

Battery performance

About the battery



NOTE The battery in the wall system provides backup power during a power outage, not power for normal use. Except during cleaning and maintenance activities, the wall system should remain connected to AC power at all times.

The device uses a rechargeable Lithium-ion smart battery. Internal circuitry enables the battery to report its condition to the device. The device displays the battery status via the LED power indicator, icons on the screen, and status messages appearing in the Device Status area of the display. Battery information may be collected using the service tool.

New batteries are shipped from the manufacturer with a 30 percent charge to extend shelf life. When installing a new battery in the device, you must plug the device into AC power to wake up the battery. If the AC power is not applied to the device, the new battery will appear discharged.

The Device Status area displays a low-battery status message when 30 minutes of power remain and again when 5 minutes remain.

Battery charging is provided by the device's internal power supply.

For a complete list of battery specifications, see the device's *Instructions for use*.

Follow best practices to extend the life of the battery

The following practices help to extend the life of the battery and the device.



WARNING Safety risk. When handling and storing Lithium batteries: Avoid mechanical or electrical abuse. Batteries may explode or cause burns, if disassembled, crushed, or exposed to fire or high temperatures. Do not short or install with incorrect polarity.

- Whenever possible, keep the monitor plugged in to charge the battery.
- Remove the battery when storing the device for an extended amount of time.
- Replace batteries that trigger a low battery status message when fully charged.
- Do not use damaged or leaking batteries.
- Store batteries with a 30 to 50 percent charge.
- Store batteries within the temperature range indicated for each period:
 - For storage less than 30 days: Maintain temperature between -4°F and 122°F (-20°C and 50°C).
 - For storage between 30 days and 90 days: Maintain temperature between -4°F and 104°F (-20°C and 40°C).
 - For storage more than 90 days up to 2 years: Maintain temperature between -4°F and 95°F (-20°C and 35°C).
- Recycle batteries where ever possible. In the United States call 1-877-723-1297 for information about recycling your Lithium-ion battery or go to the Call2Recycle website at <http://www.call2recycle.org> for additional information.
- When recycling is not an option dispose of batteries in an environmentally safe manner consistent with local regulations.

Factors affecting battery operating time

The following settings and conditions affect the battery operating time:

- The display brightness setting
- The display power-saver setting
- The device power-down setting
- Frequency and duration of alarms and alerts
- Amount of motion artifact during NIBP measurements
- Radio searching for an access point

Controls, indicators, and connectors



NOTE Your model might not contain all of these features.

Front View

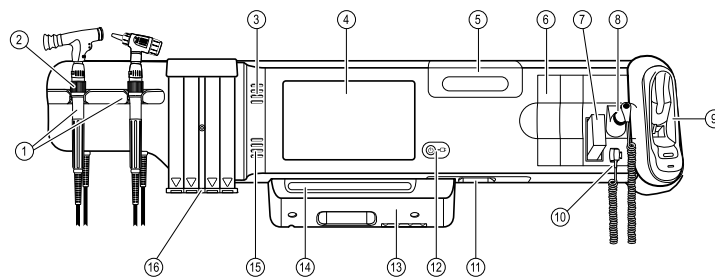

No.	Feature	Description
1	Physical assessment instruments - Handles and handle cradles	Handles accept any 3.5V Welch Allyn instrument head. Handle cradles support using one handle at a time. A handle turns on automatically when you remove it from a cradle and turns off when you return it.
2	Rheostat	Light output adjustment located on each handle. Turn clockwise to increase light output; turn counterclockwise to decrease light output.
3	Exhaust vents	Provide openings for heat to escape and cool the device.
4	LCD screen	1024 x 600 color touchscreen provides a graphical user interface.
5	Storage compartment	Provides covered storage for additional probe covers and other small accessories.
6	Expansion slots	Provide space to add modules.
7	SureTemp® Plus thermometer probe cover storage area	Provides storage for thermometer probe covers.

No.	Feature	Description
8	SureTemp® Plus thermometer probe	Supports temperature measurements from oral, axillary, and rectal sites.
9	Braun ThermoScan® PRO thermometer and dock	Support temperature measurements from the ear. Dock charges the thermometer battery.
10	SureTemp® Plus thermometer connector	Secures the probe connection to the wall system.
11	Blood pressure and pulse oximetry	See front underside view for more detail.
12	Power switch and LED	Power-on/Standby switch. The LED indicates the charging status when connected to AC power: <ul style="list-style-type: none"> • Green: The battery is charged. • Amber: The battery is charging.
13	USB/Comms cover	Houses light bar. Provides access to host USB connections for optional accessories and some routing for cords and cables.
14	Light bar	Provides a visual alarm with red and amber LEDs.
15	Speaker	Provides tones. A piezo beeper inside the monitor provides backup.
16	Specula dispenser	Dispenses KleenSpec® disposable specula in pediatric (2.75 mm) and adult (4.25 mm) sizes.

Front underside views

(Left: USB/Comms cover attached; Right: USB/Comms cover removed)

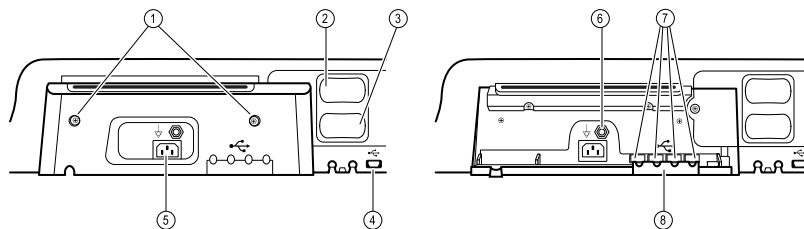

No.	Feature	Description
1	Retention screws	Attach USB/Comms cover.
2	Blood pressure	Self-contained module for easy replacement. Supports dual-lumen or single-lumen hoses.
3	Pulse oximetry	Optional Nellcor (SpO2) or Masimo Rainbow SET (SpO2 or combined SpO2/SpHb) in a self-contained module for easy replacement.

No.	Feature	Description
4	USB-to-computer connector	Provides a connection to an external computer for testing, data transfer, and software upgrades.
5	Power connection	Provides an external AC power connection.
6	Ground lug (equipotential terminal)	Supports electrical safety testing; terminal for connecting a potential equalization conductor.
7	USB connectors	Provides access to host USB connections for optional accessories.
8	USB cable retainer	Reduces strain on USB cables and connectors; helps prevent cables from disconnecting.

Back view

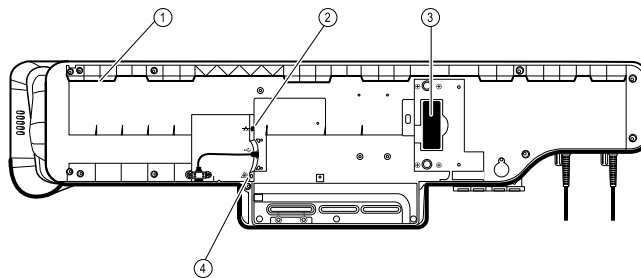

No.	Feature	Description
1	Recess for mounting bracket	Secures the monitor when mounted on the wall.
2	Ethernet RJ-45	Provides a hardwired connection to the computer network.
3	Li-ion battery	Provides backup power to wall system.
4	Nurse call	Provides a connection to the hospital nurse call system.

Accessory bin

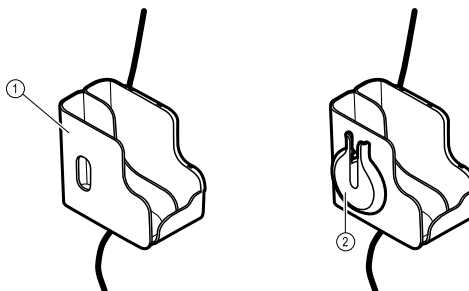

No.	Feature	Description
1	Accessory bin	Stores accessories and organizes cables.
2	SpO2 holder	Provides location to wrap SpO2 cable and attach SpO2 finger clip.

Mounting materials

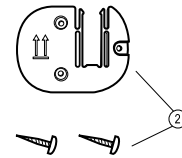
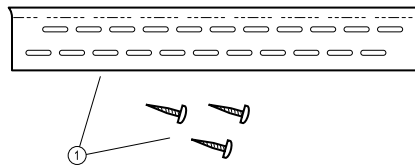

No.	Feature	Description
1	Wall mounting rail bracket and hardware	Secures the wall system to the wall.
2	Accessory bin mounting bracket and hardware	Secure accessory bin to the wall and provide routing and strain relief for power cord.

Service menu

Advanced settings and Service tabs

The Advanced tab provides password-protected access to the system's Advanced settings (or Admin mode), enabling nurse administrators, biomedical engineers, and/or service engineers to configure specific features. The Advanced tab also presents read-only information about the system.

The password to enter Advanced settings is configurable and can also be set to expire. See the "Password" topic at the end of this section for more details.



NOTE You cannot enter Advanced settings if sensors or physiological alarms are active or if vital sign measurements are displayed.

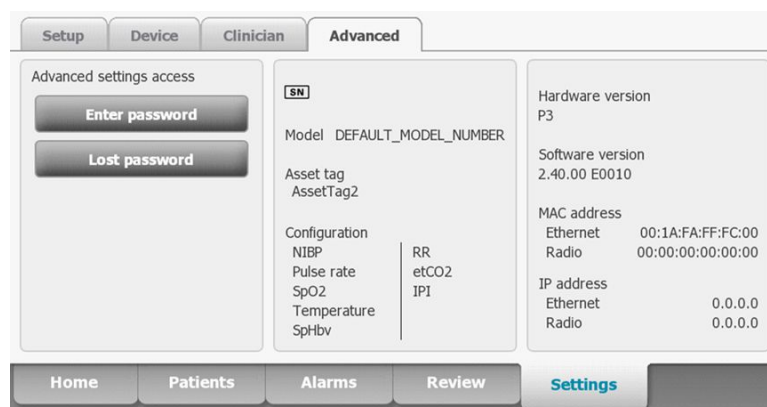

Access the Service tabs



NOTE You cannot access the Service tabs if sensors or physiological alarms are active or if vital sign measurements are displayed.

1. From the **Home** tab, touch the **Settings** tab.
2. Touch the **Advanced** tab.
3. Touch **Enter password**.
4. Enter **6345**, or the custom password for the device, as the access code and touch **OK**.
5. Touch the **Service** tab.
The **General** screen appears.
6. Perform service tasks by making selections or touching other tabs.



NOTE Service tasks and how to do them are detailed in this section.

- When you are done, touch **Exit**.
The **Home** tab appears.

General tab

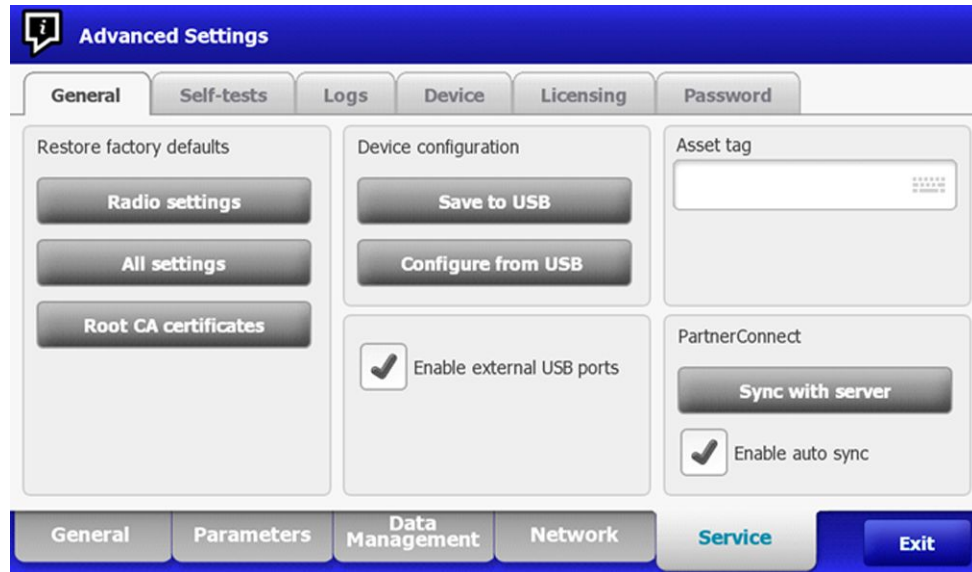

Restore factory default settings



NOTE This process deletes the custom data file. All custom data will be lost.



NOTE Restoring the radio default settings on a device equipped with a Newmar radio will remove all installed wireless certificates.

- Go to the Service tabs as described in “Access the Service tabs.”
- Touch the **General** tab.
- Restore factory default settings:
 - To restore radio settings to factory default values, touch **Radio settings**.
 - To restore all current settings to factory default values, touch **All settings**.
 - To delete all root certificates currently installed, touch **Root CA certificates**.

A confirmation dialog appears.

- Touch **OK**.

The factory default settings are restored.

If you selected **Radio settings**, the radio reboots, and the device remains powered on.

If you selected **All settings** or **Root CA certificates**, the device reboots.

Save the device configuration or custom data to a drive

You can save the device configuration or custom data (custom modifiers and custom scoring) to a USB flash drive. You can use the saved configuration to restore the device's configuration or to copy this configuration to use on other devices. You can use the saved custom data to restore custom modifiers or custom scores, or you can copy them to another device.



NOTE Not all flash drives are supported.



NOTE When saving the device configuration, the location ID and asset tag information are not included in the configuration file.



NOTE Save to USB does not support saving root CA and wireless certificates.

1. Connect a flash drive to the USB port.
2. Go to the Service tabs as described in "Access the Service tabs."
3. Touch the **General** tab.
4. Touch **Save to USB**.

A confirmation dialog appears. You can save the device configuration or custom data if either custom scores or custom modifiers are present.

5. Touch **OK**.

If the selected file or files already exist on the USB flash drive, a popup dialog appears with the message "Device configuration file already exists. Select OK to continue with save and overwrite existing file or cancel."

6. Touch **OK** to save the data to the USB drive or touch **Cancel** to exit without saving.

A confirmation message appears.



NOTE If the USB drive is incompatible, the message "Unable to save configuration to USB" appears. Touch **OK** to continue.



NOTE The configuration file is saved as CONFIG.PMP. The custom data file is saved as CUSTOMDATA.XML.

Load a device configuration, custom data, and/or root CA certificates

You can load a configuration from a USB flash drive to the device.



NOTE Not all flash drives are supported.



NOTE If your configuration includes radio parameters, make sure the radio is enabled. The radio must be enabled before you can import radio parameters.



NOTE If a device setting is not available in the configuration file, the setting returns to the factory default. This might be the case when the configuration file was saved from a device with a different firmware version.



NOTE Configuration files cannot be cloned between devices with different host software, except where the version change is minor.

1. Connect a flash drive to the USB port.
2. Go to the Service tabs as described in "Access the Service tabs."

3. Touch the **General** tab.
4. Touch **Configure from USB**.
A confirmation dialog appears.
5. Select **Device configuration, Custom data XML, and/or Root CA certificates**.
A confirmation dialog appears to confirm overwriting the existing configuration.
6. Select **OK** to proceed, or **Cancel** to quit.
The configuration from the USB flash drive overwrites the configuration on the device, and the device reboots.



NOTE If device configuration data is not present on the USB drive, that option will be disabled.



NOTE If custom modifiers are not present on the USB drive, that option will be disabled.



NOTE If root CA certificates are not present on the USB drive, that option will be disabled.



NOTE If the configuration file is incompatible, an "Unable to read configuration from USB" message appears. This might be the case if the configuration file was cloned from a device with different software version.



NOTE Configuration files can be edited or amended by loading the configuration file onto the device, making changes to the configuration through the user interface, and then saving the configuration file.



NOTE Lamarr radio configurations do not overwrite Newmar radio configurations, and vice versa. A single configuration file can store configurations for both Lamarr and Newmar radios. To create this file, first create the configuration file on a device with one type of radio and save it. Then load the configuration file on a second device with the other type of radio, configure the radio, and save the file. The newly saved configuration file includes both the Lamar and Newmar radio configurations, but the device activates only the configuration matching the device's radio type.

Delete custom data

To delete custom data, you must restore the monitor to factory defaults. Restoring the monitor to factory defaults also deletes all configuration settings.

To restore the custom configuration settings and/or custom data, save the configuration file and/or custom data to a USB drive and reload the file(s) after restoring factory defaults.

To determine if custom data is loaded on the device, complete these steps:

1. Go to the Service tabs as described in "Access the Service tabs."
2. Touch the **Device** tab.

A Custom file line displays the configuration name and the cyclical redundancy check (CRC) in the Firmware version column.

Enter an asset tag

You can enter an alpha-numeric identifier in the data field to serve as an asset tag for device identification.

1. Go to the Service tabs as described in “Access the Service tabs.”
2. Touch the **General** tab.
3. Touch  and enter up to 20 characters.
4. Touch **OK**.



NOTE If the device language changes, the asset tag remains unchanged.

Enable/disable external USB ports

The external USB ports are enabled by default. Disabling (unchecking) this option cuts off power and data to the external USB ports, making them unavailable for connections and external storage.

1. Go to the Service tabs as described in “Access the Service tabs.”
2. Touch the **General** tab.
3. If the external USB ports were previously disabled, touch **Enable external USB ports** to provide power to those ports.

A check now appears in the checkbox.

4. To disable the ports, touch **Enable external USB ports**.
The checkbox now is empty.

Send device information to PartnerConnect

The device sends technical information, such as log files, to PartnerConnect periodically. You can also manually send this information at any time by following this procedure.

1. Go to the Service tabs as described in “Access the Service tabs.”
2. Touch the **General** tab.
3. Touch **Sync with server**.
4. If the Enable auto sync was previously disabled touch **Enable auto sync** to automatically synchronize with the server.

A checkmark now appears in the checkbox.

Self-tests tab

Calibrate the touchscreen

This tab calibrates the touchscreen, if needed.

1. Go to the Service tabs as described in “Access the Service tabs.”
2. Touch the **Self-tests** tab.
3. Touch **Start**.
 - a. Touch the location indicated by the device. The device checks the current calibration. If the location coordinates and touched location match, a Calibration Confirmation dialog appears. Touch **OK** to finish.

- b. If the locations do not match, a calibration failure dialog appears. Touch **Calibrate**, and then touch the screen as indicated. When calibration is complete, a Calibration Confirmation dialog appears. Touch **OK** to finish.

Logs tab

View an error or event log

1. Go to the Service tabs as described in “Access the Service tabs.”
2. Touch the **Logs** tab.
3. View a log report.
 - To view an error log, select **Error**.
 - To view an event log, select **Event**.

Save error and event logs to a USB flash drive

This feature is available in software versions 1.71.03 and later.

You can save a copy of the error and event logs to a USB flash drive.



NOTE Not all flash drives are supported.

1. Connect a flash drive to the USB port.
2. Go to the Service tabs as described in “Access the Service tabs.”
3. Touch the **Logs** tab.
4. Touch **Save to USB**.

A confirmation dialog appears.

5. Touch **OK**.

Copies of both log files are saved to the drive.

Device tab

View device and module information

1. Go to the Service tabs as described in “Access the Service tabs.”
2. Touch the **Device** tab.

Device and module information appears for you to view.

Licensing tab

View device licenses



NOTE After activating a new license, restart the device to complete the activation process.

1. Go to the Service tabs as described in "Access the Service tabs."
2. Touch the **Licensing** tab.
A list of available licenses appears. Checks indicate installed licenses.

Password tab

Configure passwords



NOTE The keyboard for the Password tab is the English keyboard regardless of the language configured on the device.



NOTE New passwords must meet length requirements to be accepted as valid.



NOTE The keyboard for the Password tab does not set the first character to upper case.



NOTE If you forget or lose your password, you cannot access the Password tab. See "Access the Service tabs" at the beginning of this section.

1. Go to the Service tabs as described in "Access the Service tabs."
2. Touch the **Password** tab.
3. To change the current password, touch **Change password**.
 - a. Enter a new password.



NOTE The password must have between 8 and 32 characters.

A "Re-enter password" dialog appears.

- b. Touch **OK** and re-enter the new password to confirm the change.
Either a "Successful password change" or "Failed password change" dialog appears.
 - c. Touch **OK** and then proceed as needed. In the case of a failed password change, either try again or cancel the operation.
4. To lock out a user after 10 consecutive incorrect passwords, touch **Enable failed attempt lockout**.



NOTE The lockout period is 5 minutes.

5. To set an expiration for the current password, touch **Enable password expiration**, and then enter the number of days after setting a password that it will expire.

Power-up sequence

The system performs a power-on self test (POST) each time the device is powered on. During power up, the device performs a comprehensive self test of the software. If software testing is successful, the device then tests internal hardware. If all tests are successful, the system completes power up and the Home tab appears.

To perform the POST:

1. Disconnect any patient cables connected to the device.
2. Insert a fully charged battery into the device.
3. Upon each power up, confirm the following:
 - a. The light bar flashes amber.
 - b. The startup screen appears.
 - c. A beep sounds, followed by one chime.





NOTE If no chimes sound, replace the speaker as specified in "Replace the speaker."

- d. The product line logo appears at the bottom of the screen.
- e. The Home tab appears.



WARNING Equipment failure risk. The device includes a fan that circulates air through the device. If the fan does not run when you power up the device, remove it from use and inform qualified service personnel immediately. Do not use the device until the problem is corrected.

If the internal self-check is successful, the device shows its normal functions with all values blank and the device is ready for operation. If the self-check fails, an error message appears in the Device status area at the top of the screen. If a fault that could adversely affect the product is detected, the device enters a safe mode and stops monitoring patients. The device remains in safe mode until it is turned off or until it shuts down automatically after a period of inactivity.

If a system error is detected, the device becomes inactive until you press  or until the device shuts down automatically. The device displays a system fault message that contains a wrench icon () and a system fault code to aid service personnel and engineers in diagnosing the problem.

While in safe mode, the red LED bar and the piezo buzzer cycle on and off.

Troubleshooting

This section provides the following tables to help troubleshoot the device.

- **Symptoms and solutions:** These tables list symptoms you might observe, list possible causes, and suggest actions that may eliminate the problem.
- **Technical alarm messages:** These tables list messages generated by the device software when a problem is detected. The tables explain possible causes and suggest actions that can resolve the problem.

These tables can help you diagnose and fix a problem. They do not replace basic troubleshooting skills. You must still trace the source of the problem to the board or module level to decide the best course of action. Welch Allyn does not support component-level repair to the board or module. For available replacement parts, see “Field Replaceable Units.”



WARNING Do not perform troubleshooting on a device that is emitting smoke or exhibits other signs of excessive overheating. Disconnect the device from AC power and call Welch Allyn Technical Support immediately.



CAUTION Replace parts, components, or accessories only with parts supplied or approved by Welch Allyn. The use of any other parts can lead to inferior device performance and will void the product warranty.

Symptoms and solutions

Power

Symptom	Possible cause	Suggested action
The device does not power up	A new battery was installed	Connect AC power to wake up the battery.
	The AC power is disconnected	Connect AC power.
	The power cord is defective	Replace the power cord.
	The battery is discharged	Charge the battery.
	The power button is defective	Replace the power button.
	An internal connection is faulty	Check the power-flex cable connection at J6 on the main board.

Symptom	Possible cause	Suggested action
		Check the AC power harness connections from the IEC connector to the power supply.
		Check the power harness from the power supply J2 to J30 on the main board.
		Check the battery power harness from J2 on the battery connector board to J29 on the main board.
	The power supply is defective	Check the output voltage on the power supply. The voltage should be $15\text{ V} \pm 0.45\text{V DC}$. If it is not, replace the power supply.
	The battery is defective	Charge the battery for 5 hours. If the battery icon on the display still shows an empty battery symbol, replace the battery.
	The main board is defective	Replace the main board.
The battery doesn't charge or run time is low	The battery is defective	Charge the battery for 5 hours. If the battery icon on the display still shows an empty battery symbol, replace the battery.
	The battery connector board is defective	Check the battery connector board for an open short or broken connector and replace if necessary.
	The battery has reached the end of its useful life	Use the service tool to check cycle count. If the cycle count exceeds 300, replace the battery.

Hardware

Mechanical Symptom	Possible cause	Suggested action
Noisy fan	Dust build up	Use canned air to blow dust out of fan.
	Fan is out of balance	Replace fan.

Mechanical Symptom	Possible cause	Suggested action
Cracks in housing	Non-approved cleaning agents	Replace plastic housing as necessary. Use only approved cleaning agents.

Display

Symptom	Possible cause	Suggested action
The touchscreen does not respond	Software error	Reboot the device. Press and hold the power button until the device shuts down. Note Any configuration settings not saved as default will be lost. Press the power button to restart.
	The touchscreen is out of calibration	In Advanced Settings, touch the Service > Self-tests tabs, then recalibrate the screen.
	The touchscreen lock is activated	To unlock the touchscreen, touch  at the bottom of the screen. To disable the touchscreen lock, touch the Settings > Device tabs, then uncheck Allow display lock timeout .
	An internal connection is faulty	Check the connection at J48 on the main board with display flex cable.
	A display flex cable is broken	Replace the touchscreen and display assembly.
	The main board has a faulty touchscreen controller	Replace the main board.
	Excessive force or prolonged rubbing in an area of the touchscreen	Replace the touchscreen.
The display is blank when the power is on	The device is in Power-Saver mode	Wake the display by touching the screen or the power button.
	The device powered down after a period of inactivity	Turn on the device by pressing the power button. In Advanced Settings, touch the General > Display tabs, then set Device power down to the desired interval.

Symptom	Possible cause	Suggested action
	An internal connection is faulty	Check the display harness connections at the display and J19 on the main board. Replace the cable if damaged.
	A cable is damaged	Replace the cable.
The display is dim	The brightness setting is too low	Increase the brightness setting. Touch the Settings > Device tabs, touch Defaults , then set Display brightness to the desired level.
	The display has reached the end of its useful life	Replace the display.

User interface

Symptom	Possible cause	Suggested action
Unable to access advanced settings or enter the advanced settings code	Patient monitoring is active or being simulated	Discontinue patient monitoring or stop the simulation.
	The parameter alarm is on	Dismiss the alarm.
	Intervals are turned on	Stop intervals.
Desired profile does not appear in the Profiles tab	The profile license is not installed	In Advanced settings, touch the Service > Licensing tabs. Verify that the profile license box is checked. If not, purchase the license and install it using the service tool.
	The profile is not enabled	In Advanced settings, touch the Device tab, then check the profile(s) you want to enable.

Communication

Symptom	Possible cause	Suggested action
Cannot communicate through the USB client connection	The battery charge is low	Connect the device to AC power and allow the battery to fully charge.
	The communications board does not receive power	Check the voltage from J49 on the main board for +5.0, ±0.5V DC. Replace the main board if necessary.
	The USB client is defective	Test the connection by connecting a PC running the service tool. Verify that the service tool is configured properly on the PC to communicate with the device. See the service tool help files. Replace the power cable to the communications board.
USB accessories do not communicate with the monitor	The accessory is defective	Replace with a known good accessory.
	The communications board is not receiving power	Check the voltage from J49 on the main board for +5.0, ±0.5V DC. Replace the main board if necessary.
	One or more USB host connections are defective	Test the connection with a USB thumb drive. If no power or enumeration is present, such as an LED on a thumb drive, replace the communications board.
	A USB connection from the communications board to the main board is faulty	Verify that the USB cables are connected correctly. Replace the USB cables.
The device does not communicate via Ethernet with the computer network	The device is not configured properly	Check the settings with your network administrator.
	The communications board is not receiving power	Check the voltage from J49 on the main board for +5.0, ±0.5V DC. Replace the main board if necessary.
	The Ethernet connection from the main board is faulty	Test the internal Ethernet cable. Replace if necessary. Verify that the shim is installed, if required, on the Ethernet cable connector at J11. See the reassembly notes for the main board.

Symptom	Possible cause	Suggested action
	The network Ethernet switches are not set to the correct speed to work with the device	Set the switches to 10 Mbps full duplex.
	The cable run to the switch is too long	Use a shorter patch cable.
The radio does not connect to the network	The device is out of range of the access point	Check the network status screen's RSSI value.
	The device is not configured properly	Check the settings with your network administrator.
	The antenna is defective	Check the antenna cable and antenna connection. Replace the cable and antenna if necessary.
	The communications board is not receiving power	Check the voltage from J49 on the main board for +5.0, $\pm 0.5V$ DC. Replace the main board if necessary.

Alarms

Symptom	Possible cause	Suggested action
The light bar does not turn on	No alarm was triggered	Verify that the light bar flashes when the system starts. Verify that the alarm is triggered by a visual indicator in the message status area and an audio alarm occurs.
	There is a faulty connection	Check the light-bar harness and connections at the light bar and J46 on the main board. Replace the defective cable if necessary.
	The light-bar board is defective	Apply +3.3V to pin 1 of the harness and ground to pin 2. Verify that the amber LEDs illuminate. Connect the ground to pin 3. Verify that the red LEDs illuminate. If one or both do not illuminate, replace the LED light bar.
	The main board is defective	Verify that there are +3.3V at pin 1 of J46 on the main board.
No audible alarm occurs	No alarm was triggered	Verify that the alarm is triggered by a visual indicator in the message status area

Symptom	Possible cause	Suggested action
		and light bar. Listen for audible sounds on start up.
	The alarm audio is set to Off	Touch the Alarms > General tabs, then select Alarm audio on . In Advanced settings, touch the General > Alarms tabs, then disable Allow user to turn off general audio .
	The alarm audio is set too low	Touch the Alarms > General tabs, then set Volume to the desired level. In Advanced settings, touch the General > Alarms tabs, then set Minimum alarm volume to the desired level.
	There is a faulty connection	Check the speaker harness and connections at the speaker and J12 on the main board. Replace the defective cable if needed.
	The speaker is defective	Replace the speaker.
	The main board is defective	Test speaker output using an oscilloscope on J12.

NIBP

Symptom	Possible cause	Suggested action
The NIBP frame on the display is blank	The USB cable is defective	Replace the USB cable.
	The NIBP module is not connected	Check the internal USB connection.
	The NIBP module is not functional	Check the error logs for NIBP errors. See the service tool help files for details on specific errors and suggested actions. Check with Welch Allyn for software updates.
	If no NIBP error is logged, the main board might be defective	Replace the main board if necessary.

SpO2

Symptom	Possible cause	Suggested action
The SpO2 frame on the display is blank	The USB cable is defective	Replace the USB cable.
	The SpO2 module is not connected	Check the internal USB connection.
	The SpO2 module is not functional	Check the error logs for SpO2 errors. See the service tool help files for details on specific errors and suggested actions. Check with Welch Allyn for software updates.
	If no SpO2 error is logged, the main board might be defective	Replace the main board if necessary.

SpHb

Symptom	Possible cause	Suggested action
The SpHb frame on the display is blank	The UI license is not installed.	Purchase a license and install the license using the service tool.
	The wrong sensor is connected.	Use a sensor that supports the SpHb parameter.
	The sensor or cable expired.	Replace the sensor or cable.
	The sensor or cable is defective.	Replace the sensor or cable.
	The Masimo SpO2 module does not have the SpHb parameter enabled.	Purchase the parameter and install using the service tool.
The SpHb frame is unavailable	The selected profile does not support SpHb.	Change the profile to Intervals Monitoring or Continuous Monitoring.

ECG

Symptom	Possible cause	Suggested action
No LTA alarm associated with patient injury or death	LTA license not installed	Remove device from service, contact Welch Allyn Technical Support, and return to Welch Allyn for service.
	V-Tach, V- Fib, Asystole detection disabled	
	invalid data	

Symptom	Possible cause	Suggested action
No LTA or ECG tile shows Arrhythmia detection off	Alarms off in advanced settings	Turn on alarms.
	No license	Install license.
	ECG module unable to detect arrhythmias	Contact Welch Allyn Technical Support. Replace the module if necessary.
No ECG pane	Module not connected	Check ECG module LED.
	Faulty patient cable	Check cable.
	Faulty module cable	
	CVSM software does not support ECG	Update software.
	Profile not set to Continuous Monitoring	Set profile to Continuous Monitoring.
ECG tile disabled	Patient type set to Neonate	Change patient type to Adult or Pediatric.
No waveform	Start button not activated	Touch Start on ECG tile to begin waveform streaming.
	ECG gain too high	Reduce ECG gain.
	Patient type set to Neonate	Change patient type to Adult or Pediatric.
Noisy waveform	50 or 60 Hz filter disabled	Enable filter.
	Wrong mains filter value selected (50 Hz versus 60 Hz)	Set the filter to the correct mains frequency for your location.
	Poor lead placement	See DFU for proper placement.
No pacemaker or ECG tile shows pacemaker detection off	Pacemaker detection Off	Touch the Settings > Setup tabs, then touch the ECG vertical tab. Enable Patient has a pacemaker .
	ECG module unable to detect pacemaker	Contact Welch Allyn Technical Support. Replace the module if necessary.
No alarming snapshot was auto-printed	Device does not have a printer	None. Connex IWS does not have a printer.

Symptom	Possible cause	Suggested action
Printed waveform is too small	ECG gain and/or sweep speed is set too low	Increase gain and/or sweep speed and reprint.
Snapshot button is disabled	An alarming snapshot is in progress Less than one minute has elapsed between snapshots	Wait for up to one minute for the button to enable.
Module LED off	Module is not receiving power	Replace cable.
Module LED yellow	Internal error	Power cycle device or disconnect and then reconnect cable.
Module LED steady green	Module powered on	Working as designed.
Module LED flashing green	Sending data	Working as designed.

Weight scale

Symptom	Possible cause	Suggested action
Weight does not appear in manual parameter frame	The weight was not selected in Advanced settings	In Advanced settings, touch the Parameters tab, then select Weight . Note You can select only four manual parameters.
	The weight scale is not licensed	Purchase a license and install the license using the service tool.
	The weight scale is not connected	Check cables and connections. Use the service tool to test connectivity. Replace cables.
	The weight scale is not configured	Consult the scale directions for use.

Temperature

Symptom	Possible cause	Suggested action
The temperature frame on the display is blank	The USB cable is defective	Replace the USB cable.
	The temperature module is not connected	Check the internal USB connection.
	The temperature module is not functional	Check the error logs for temperature errors. See the service tool help files for

Symptom	Possible cause	Suggested action
		details on specific errors and suggested actions.

Braun ThermoScan PRO 4000 thermometer





Symptom	Possible cause	Suggested action
The thermometer batteries don't charge	The rechargeable battery pack no longer takes a charge	Replace the rechargeable battery pack.
	Primary AA batteries are installed in the thermometer	Replace the batteries with a rechargeable battery pack.
The dock LED is green, but the battery is low or depleted	Primary AA batteries are installed in the thermometer	Replace the batteries with a rechargeable battery pack.
	The dock is defective	Replace the dock.
Thermometer readings do not transfer to the device	The external USB cable is unplugged	Check the external USB connection.
	The USB bus has stopped communicating with the Braun dock. (The device displays wrench error #00000014.)	Reboot the host device.



NOTE For additional troubleshooting tips for the thermometer, see the manufacturer's product documentation.

Braun ThermoScan PRO 6000 thermometer

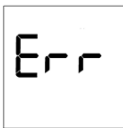
Symptom	Possible cause	Suggested action
Braun measurements are inaccurate	Probe lens is displaced	Examine lens for displacement. If you observe a gap in the seam between the bezel and the lens, replace the thermometer.
	Use inconsistent with DFU	See DFU for proper operation. Perform the Braun functional verification test using the service tool or the manual test described in this manual. Replace as necessary.
	Ingress of cleaning solutions has corroded the electronics	Replace the thermometer. Review cleaning procedures in the DFU.
Temperature tile displays ++ Braun displays HI	Temperature taken is not within typical human temperature range. HI will be displayed when	Change probe cover to reset. Then, make sure thermometer is properly inserted and take a new temperature.

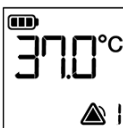
Symptom	Possible cause	Suggested action
	temperature is higher than 108°F (42.2°C).	
Temperature tile displays -- Braun displays LO 	Temperature taken is not within typical human temperature range. LO will be displayed when temperature is lower than 68°F (20°C).	
Braun displays "POS" error 	The infrared monitor cannot find a temperature equilibrium and allows no measurement.	Change the probe cover to reset. Restrict patient movement and ensure that the positioning of the probe is correct and remains stable while taking new temperature.
Braun displays "Err" error 	Ambient temperature is not within the allowed operating range (50 – 104 °F or 10 – 40 °C) or changing too rapidly.	Wait 20 seconds until thermometer turns off automatically, then turn on again. Ensure thermometer and patient are in an environment for 30 minutes where the temperature is between 50 °F and 104 °F or 10 °C and 40 °C.
Braun display is blank or displays all icons 	System error	Wait 20 seconds until the thermometer turns off automatically, then turn on again. If error persists, reset the thermometer by removing the batteries and putting them back in. If error still persists, batteries are dead. Insert new batteries. If error still persists, contact local Welch Allyn Service Center or representative.
Braun displays Alert icon with "1" in lower right corner 	Technique Compensation (PerfecTemp) technology is not functioning or disabled	Open the temperature tab in Advanced settings to configure PerfecTemp*.
Braun displays Alert icon with "U" in lower right corner	Unadjusted Operating Mode is enabled	Open the temperature tab in Advanced settings to configure Unadjusted Operating Mode*.

Symptom	Possible cause	Suggested action
		
C/F button is not functional	Celsius only enabled	Open the temperature tab in Advanced settings to disable Celsius only selection*.
Pulse timer button is not functional	Pulse timer disabled	Open the temperature tab in Advanced settings to enable pulse timer*.
Braun displays lock icon and is unresponsive	Security mode enabled and anti-theft timer has expired	Return Braun thermometer to dock to unlock. Security mode is set on temperature tab in Advanced settings.
Braun display is blank after performing upgrade	Software upgrade was interrupted	Remove and replace the battery while holding the C/F button or return to the dock while holding the C/F button. Retry upgrade.
*Host device Braun 6000 settings override configuration settings from Welch Allyn Service Tool.		



NOTE For additional troubleshooting tips for the thermometer, see the manufacturer's product documentation.

Manual parameters

Symptom	Possible cause	Suggested action
The manual parameter frame does not appear on the Home tab	No manual parameters are selected in Advanced settings	In Advanced settings, touch the Parameters tab, then select the desired manual parameters. Note You can select only four manual parameters.
BMI is not displayed	The BMI parameter is not selected	Select the BMI parameter in the advanced settings.
	Height or weight was changed	Adjusting the height or weight clears BMI.
	Weight scale not connected	BMI is available only from a weight scale with height.

Barcode reader

Symptom	Possible cause	Suggested action
The barcode reader powers on but does not transfer data	No license is installed	Purchase a license and install the license using the service tool.
	The barcode reader is not programmed to use USB Com Port Emulation mode	Refer to the manufacturer's documentation to program the barcode reader to USB COM Port Emulation mode.
	The barcode reader is not supported	For Honeywell model 4600g barcode readers, verify that the PID is set to 020A.
	The barcode scanner did not enumerate properly	Power cycle the Connex device.
The patient ID or clinician ID do not match	The barcode scanner is not programmed to properly interpret the barcode	Program the barcode scanner to turn on required symbology and to also add or delete characters to form correct ID.

Errors

Symptom	Possible cause	Suggested action
#000000001	An internal software error	Power down and restart. If the error persists, call Welch Allyn Technical Support for service.
#000000002	An unclassified hardware error	
#000000003	Graphics RAM POST	
#000000004	System RAM POST	
#000000005	Watchdog POST	
#000000006	FLASH initiation failed	
#000000007	A display system error	
#000000008	A real-time clock error	
#000000009	An audio system error	
#000000010	An Ethernet system error	
#000000011	The touchscreen controller failed	

Symptom	Possible cause	Suggested action
#000000012	Five or more SMBUS errors over a 1-minute period occurred	
#000000013	The communications module or main board failed	
#000000014	Main board USB hub failure	
#000000015	Software watchdog timer reset	

Technical alarm messages

This section presents tables of technical alarm and information messages to help you troubleshoot issues on the device. For information about physiological, dialog, or informational messages, see the device's directions for use.

When the device detects certain events, a message appears in the Device Status area at the top of the screen. Message types include the following:

- **Information messages** appear on a blue background.
- **Very low-priority alarms** appear on a cyan background.
- **Low- or medium-priority alarms** appear on an amber background.
- **High-priority alarms** appear on a red background.

Technical alarm messages are low priority or very low priority unless noted in the Message column.

You can dismiss a message by touching the message on the screen, or, for some messages, you can wait for the message to time out.

To use these tables, locate the message that appears on the device in the left column of the table. The remainder of the row explains possible causes and suggests actions that can resolve the issue.

If you cannot resolve the issue, use the service tool to read the error log files or use the service tool to perform a functional test¹ on the module reporting the message.

NIBP messages

Message	Possible cause	Suggested action
Alarm		
NIBP air leak; check cuff and tubing connections.	The NIBP module has an air leak	Check the cuff, tubing, and connections for leaks. If no leaks are found, retake the measurement. If the message reappears, replace the NIBP module.
NIBP not functional. Call for service.	Internal errors or messaging errors occurred	Check the error logs for NIBP errors. See the service tool help files for details on specific errors and suggested actions.

¹ Requires the service tool, Gold licensed edition.

Message	Possible cause	Suggested action
		Check with Welch Allyn for software updates.
	The ambient temperature is out of range	Use the monitor in the specified temperature range.
Unable to determine NIBP; check connections; limit patient movement.	Pressure exceeded the maximum limit for this patient mode	Check connections; limit patient movement. Clear the alarm and retry NIBP.
Unable to determine NIBP; check connections and tubing for kinks.	NIBP tubing on the outside of the device is kinked	Check the connections and tubing for kinks. Clear the alarm and retry NIBP.
	The NIBP module needs to be calibrated	Perform NIBP calibration.
	Tubing inside the NIBP module is kinked	Replace the NIBP module.
Incorrect NIBP cuff size; check patient type.	A neonate cuff is in use with the monitor in adult or pediatric mode	Check the patient type and cuff size. Clear the alarm and retry NIBP.
Inflation too quick; check NIBP cuff and tubing connections.	NIBP inflation was too quick	Check the connections and tubing for kinks. Clear the alarm and retry NIBP.
Unable to determine NIBP; check inflation settings.	Target pressure was too low	Check inflation settings and change as necessary. Clear the alarm and retry NIBP.
		Change the inflation setting.
	Too many attempts	Change the inflation setting.
Information		
User cancelled NIBP reading.	Blood pressure reading cancelled by user	Touch OK to dismiss. Touch NIBP Start button to dismiss and restart the NIBP reading.
Tube type does not match device configuration. (NIBP measurement is available)	The tube type connected to the monitor does not match the NIBP configuration.	Touch OK to dismiss. Configure the NIBP advanced settings to match the tube type, patient type, and algorithm.
	The single lumen switch on the NIBP connection is stuck	Use a small screw driver to press the switch in and release until the spring returns the switch to the dual-lumen position.

Message	Possible cause	Suggested action
Excessive patient movement.	The NIBP reading was deemed not precise	Touch OK to dismiss. Limit patient movement and restart the NIBP measurement.

SpO2 and SpHb messages

Message	Possible cause	Suggested action
Alarm		
SpO2 not functional. Call for service.	The sensor is defective	Replace the SpO2 sensor with a known good sensor.
	An internal error occurred	Update the host software to the current version. Check the error logs for SpO2 errors. See the service tool help files for details on specific errors and suggested actions.
		Check with Welch Allyn for software updates.
Attach SpO2 sensor to monitor.	The sensor was not detected	Check the sensor connection. Replace the sensor.
Replace the SpO2 sensor.	The sensor is faulty	Replace the sensor.
	The sensor expired (applies only to SpO2 / SpHb sensors)	Replace the sensor.
	No sensor is connected	Connect the sensor.
	The patient cable is faulty	Replace the cable.
	The SpO2 module is faulty	Verify module functionality by replacing the sensor with the applicable SpO2 tester. If the message persists after you have installed the SpO2 tester, replace the module.
Searching for SpO2. (High-priority alarm)	The SpO2 sensor is not attached to the patient's finger	Touch the alarm icon or the SpO2 frame to dismiss the alarm. Set the SpO2 Alarm limits to Off . Reattach the SpO2 sensor to the patient's finger.

Message	Possible cause	Suggested action
Low SpO2 signal quality. Check sensor. Low SpHb signal quality. Check sensor. Low perfusion. Check sensor.	Poor sensor placement on the patient.	Remove the sensor from the patient and reapply.
	The patient cable or sensor is defective	Replace the patient cable or sensor.
	The SpO2 module is faulty	Verify module functionality by replacing the sensor with the applicable SpO2 tester. If the message persists after you have installed the SpO2 tester, replace the module.
SpO2 mode only. Check sensor or cable.	The sensor is operating as an SpO2-only sensor because it failed to calibrate properly	Reattach the cable to the monitor.
		Remove the sensor from the patient and reapply.
SpO2 sensor expires in...	The sensor will expire soon	Replace the sensor.
Replace the SpO2 cable.	The cable is not functioning properly	Replace the cable.
	The SpO2 module is faulty	Verify module functionality by replacing the sensor with the applicable SpO2 tester. If the message persists after you have installed the SpO2 tester, replace the module.

Note This message appears only on devices configured with SpHb.

Temperature messages (SureTemp)

Message	Possible cause	Suggested action
Alarm		
Connect temperature probe.	No probe is connected	Connect a temperature probe and retry.
	The probe is faulty	Replace the temperature probe.
	The temperature module returned a connect probe message	Connect a temperature probe and try again. If a probe is already connected, replace the probe.
	The SureTemp temperature module is faulty	Verify module functionality by replacing the temperature probe with the CAL-KEY assembly. If the message persists after you have

Message	Possible cause	Suggested action
		installed the CAL-KEY assembly, replace the module.
Insert correct color-coded probe well.	The probe well is missing	Insert a temperature probe well.
	The SureTemp temperature module is faulty	Verify that the lever arm on the back of the probe well housing is engaging switch SW1 on the temperature PCBA. If the problem persists, replace the module.
Replace temperature probe.	The probe is faulty	Replace the temperature probe.
	The SureTemp temperature module is faulty	Verify module functionality by replacing the temperature probe with the CAL-KEY assembly. If the message persists after you have installed the CAL-KEY assembly, replace the module.
Retry temperature measurement. Note This message often accompanies other temperature messages.	A probe heater or data error occurred	Retry the temperature measurement. If the problem persists, replace the probe.
	User settings require adjustment	Adjust the user settings and retry.
	The ambient temperature is out of range	Operate the monitor within the specified temperature range. Retry patient temperature measurement.
	The SureTemp temperature module is faulty	Verify module functionality by replacing the temperature probe with the CAL-KEY assembly. If the message persists after you have installed the CAL-KEY assembly, replace the module.
Temperature time limit exceeded. Retry temperature measurement.	The direct mode timed out	Return the temperature probe to the probe well and retry measurement.
Information		
Tissue contact lost.	Lost tissue contact while attempting to acquire temperature reading or acquired reading was performed with limited tissue contact	Touch OK to dismiss the message. Start a new temperature reading.

Temperature messages (Braun ThermoScan PRO)

Message	Possible cause	Suggested action
Alarm		
Unable to detect temperature. Retry measurement.	Measurement was not taken	Retry measurement.
	Measurement recalled from memory	
	Loose or broken USB cable	Check USB connection and cable. Replace as necessary.
	Dead battery Braun display is blank or battery icon shows one bar	Recharge or replace battery.
	Braun displays "POS" error	Change the probe cover to reset. Restrict patient movement and ensure that the positioning of the probe is correct and remains stable while taking new temperature.
	Braun displays "Err" error Ambient temperature is outside the allowed operating range (50–104 °F or 10–40 °C) or changes too rapidly	Wait 20 seconds until thermometer turns off automatically, then turn on again. Ensure thermometer and patient are in an environment for 30 minutes where the temperature is between 50 °F and 104 °F or 10 °C and 40 °C.
Thermometer might be docked improperly.	Thermometer is not properly docked	Re-dock thermometer.
	Thermometer has dirty contacts	Clean dock and thermometer contacts with 70 percent isopropyl alcohol. See Cleaning Instructions for Braun ThermoScan PRO 6000.
Braun temperature not functional. Call for service.	Communication timeout BDD transfer took longer than expected POST did not complete or failed within the expected time period	Remove and replace battery to reset, then return thermometer to dock. If error persists, return for service.

Message	Possible cause	Suggested action
	POST failure Braun display is all icons or blank	
	Unsupported parameter Sensor data definition error (occurs when the proxy is unable to set parameters to the sensor using local DDS)	
	WACP serialization failure	
	Braun maximum battery voltage exceeded Battery voltage is too high	
	Braun BDD compatibility	
	Braun BDD unexpected compatibility	
	Braun send message failure	
	Braun bridge failure	
Temperature is not functional. Call for service.	An internal error occurred	Check the error logs for temperature errors. See the service tool help files for details on specific errors and suggested actions. Check with Welch Allyn for software updates.
	The USB cable is disconnected	Check the USB cable.
	The battery is depleted or missing	Replace the batteries.

ECG messages

Message	Possible cause	Suggested action
Alarm		
Electrodes off:	Device is configured for 5 leads, but you are using 3 leads	Ensure that the device is configured for the appropriate number of leads in Advanced settings.
IEC electrodes (N, F, R, L, C)	(N, F, R, L, C) disconnected	Connect (N, F, R, L, C) lead.

Message	Possible cause	Suggested action
AHA electrodes (RA, LA, LL, V)	(RA, LA, LL, V) disconnected	Connect (RA, LA, LL, V) lead.
Electrode x off.	One lead is disconnected	Check the connections of all leads.
ECG not functional.	ECG module error, WACP error, Data failure	Check the USB cable and connections. Perform functional test. If the test fails, contact Customer Care and replace the ECG module if necessary.
	ECG module has not transmitted ECG data for the past 30 seconds	Check the USB cable and connections. Perform functional test. If the test fails, contact Customer Care and replace the ECG module if necessary.
	ECG module disconnected	Check the ECG module connection to Connex device.
	Unexpected alarm compatibility bits	Restart the Connex device and the ECG module; if the error persists, contact Customer Care. Perform functional test. If the test fails, contact Customer Care and replace the ECG module if necessary.
	Cannot analyze ECG.	Module unable to analyze the ECG signal for V-Tach, V-Fib, and/or asystole
Cannot measure ECG.	ECG module has been unable to detect and ECG waveform for the past 30 seconds	Check electrodes and leads, and replace as needed.

Message	Possible cause	Suggested action
		<p>Check the patient cable connection to the ECG module.</p> <hr/> <p>Perform functional test. If the test fails, contact Customer Care and replace the ECG module if necessary.</p>
Searching for respiration.	ECG unable to measure patient respirations	<p>Check electrodes and leads, and replace as needed.</p> <hr/> <p>Check the patient cable connection to the ECG module.</p> <hr/> <p>Perform functional test. If the test fails, contact Customer Care and replace the ECG module if necessary.</p>
	You are not using Lead II to view respiration	Ensure that you are viewing Lead II for respiration.
	Attempting to acquire ECG/ Impedance respiration	<p>Check electrodes and leads, and replace as needed.</p> <hr/> <p>Check the patient cable connection to the ECG module.</p> <hr/> <p>Perform functional test. If the test fails, contact Customer Care and replace the ECG module if necessary.</p>
Respiration alarm limits changed.	Respiration physiological alarm limits were modified because the respiration source changed	Reset alarm limits.

Weight scale messages

Message	Possible cause	Suggested action
Weight scale not functional. Call for service.	The weight scale is not operating properly	<p>Check the scale.</p> <hr/> <p>Use the service tool to check connectivity with adapter.</p> <hr/> <p>Replace cables.</p>

Message	Possible cause	Suggested action
		Replace adapter.

Communications module messages

Message	Possible cause	Suggested action
Communications module did not power on properly. Power down the device. (High-priority alarm)	The communications board is not connected properly to the main board	Check the USB connection at J4. Check the Power connection at J50. Check the voltage from J49 on the main board for +5.0V \pm 0.5V DC. Replace the main board if necessary.
	The communications board malfunctioned	Replace the communications board.

Radio messages (Lamarr)

Message	Possible cause	Suggested action
Alarm		
Radio not functional. Call for service.	A hardware failure occurred	Replace the radio.
	The radio has the wrong software	Update the radio software.
Radio error. Power down and restart.	The monitor and the radio failed to establish communication with each other	Power down and restart the monitor. If the problem persists, check the following: <ul style="list-style-type: none"> The USB and power connections from the main board to the communications board. The connection from the radio board to the communications board. Monitor and radio software compatibility. Replace the radio if necessary.
Unable to establish network communications. Radio out of network range.	The radio is no longer communicating with the access point	Verify that the monitor is within the radio coverage area. Verify that the radio is correctly configured to the network. If this message appears intermittently, check the RSSI value.

Message	Possible cause	Suggested action
Unable to establish network communications. Call for service.	Unable to get an IP address from the DHCP server	Verify that a DHCP server is available on the network. The monitor requires an IP address from a DHCP server.
Radio Software upgrade failed.	The connection with the host was broken	Re-establish the connection and try again.
	The radio was not provisioned correctly	Reset radio to factory defaults and try again.
	Hardware error	Replace the radio.
Information		
Radio software upgrade in progress. Do not shut down.	Radio software is being written to the radio	Do not interrupt the upgrade until complete.
Radio card rebooting; please wait.	The radio is restarting as part of the software upgrade	Do not interrupt the upgrade until complete.

Radio messages (Newmar)

Message	Possible cause	Suggested action
Alarm		
Radio not functional. Call for service.	Internal radio/communication error	Reboot radio. If error persists, reinstall software.
		If error persists after reinstalling software, check for a software update and apply it.
		If error persists after updating software, replace the radio.
Unable to establish network communications.	Unable to associate with access point after 30 seconds	Check radio configuration.
		Consult IT and check network.
	Unable to authenticate after 30 seconds	Check radio configuration.
		Consult IT and check network.
		If using FIPS, verify that authentication types are compatible with FIPS.
Radio card DHCP timeout.	Unable to establish communications between radio and DHCP server (network)	Check DHCP server.
		Check radio configuration settings.

Message	Possible cause	Suggested action
	DHCP request timed out before obtaining DHCP address	
Invalid radio configuration. Reconfigure and try again.	Radio configuration error	<p>Consult IT to verify that wireless radio settings match network settings.</p> <p>If using FIPS, verify that authentication types are compatible with FIPS.</p> <p>If problem persists, reset to factory defaults.</p> <p>If problem persists after factory reset, check for a software update and apply it.</p> <p>If problem persists after updating software, replace the radio.</p>
Lost network communications. Radio out of network range.	Radio was communicating but is out of range, lost power, or for some other reason is no longer able to continue communications with the access point	<p>Move device into network coverage area.</p> <p>Check access point and ensure it is powered on.</p> <p>Verify that RSSI value is greater than -65 dbi.</p> <p>Verify wireless radio settings.</p> <p>Check network configuration.</p>
Configuration invalid without certificates. Install certificates and try again.	Radio configuration certificate error	<p>Verify that certificate settings are correct and not expired.</p> <p>Load certificates.</p> <p>Verify radio configuration settings and authentication types.</p> <p>If problem persists, reset to factory defaults and reload certificates.</p> <p>If problem persists after factory reset, check for a software update and apply it.</p> <p>If problem persists after updating software, replace the radio.</p>

Message	Possible cause	Suggested action
Information		
Certificate load failed.	Radio customer certificate did not load	Check that certificate includes all required items. Check certificate server log.
Certificate load successful.	Radio customer certificates loaded successfully from the host	No action required.

Ethernet messages

Message	Possible cause	Suggested action
Alarm		
Network not found; check network cable connection.	A network cable is unplugged	Check the network cable connection.
	A network connection is broken elsewhere	Check network wiring.

USB messages

Message	Possible cause	Suggested action
Alarm		
External device not recognized.	An unrecognized external device is connected	Reconfigure the external device.
		Replace the external device.
		Disconnect the unsupported device.
USB Communication failure. Call for service	An internal or external device is connected but failed enumeration	Power down and restart.
		Check the external device.
		Check external and internal USB connections.
Information		
External device not licensed for use.	A device requiring a license has been connected to the USB connection	Obtain an authorization code from Welch Allyn to activate the license.
Unable to save configuration to USB.	There was a problem writing the configuration file to the USB flash drive	Use a Welch Allyn approved flash drive.

Message	Possible cause	Suggested action
		Verify that the flash drive is not locked.
		Verify that there is space available on the flash drive.
Unable to read configuration from USB.	There was a problem reading the configuration file to the USB flash drive	Restart and try again.
USB accessory disconnected.	The USB cable between an external device and the monitor is disconnected	Confirm that the USB cable is connected to the device and the monitor.

System messages

Message	Possible cause	Suggested action
Alarm		
Set date and time.	The date or time is not set	Set the date and time.
	The date or time is not set properly	Reset the date or time.
Incompatible Welch Allyn device.	A known USB device enumerates, but fails	The device may be faulty. Test a known good device.
Unexpected restart occurred. Call for service.	A system error caused the monitor to restart	Check Event and Error logs. Run the service tool verification test.
Information		
Device shutdown is not available at this time.	The device cannot perform an immediate shutdown	Touch OK to dismiss message. If any process is active, wait for it to complete before attempting shutdown. If the device is unresponsive, hold down the power button until device shuts down. Note Any configuration changes not saved as default are lost.

Battery power manager messages

Message	Possible cause	Suggested action
Alarm		

Message	Possible cause	Suggested action
Low battery 5 minutes or less remaining. (High-priority alarm)	Battery power is extremely low	Plug the monitor into AC power. If not plugged in, the monitor automatically powers off.
Battery is absent or faulty.	There is no battery in the monitor	Insert a battery.
Battery is absent or faulty. Call for service.	The battery is faulty	Replace the battery.
Low battery 30 minutes or less remaining.	The battery power is low	Touch the alarm icon to dismiss or plug the monitor to AC power.
Information		
Device is operating in battery mode.	The AC power cord has been disconnected	Touch the alarm icon to dismiss or plug the monitor to AC power.

Configuration Manager messages

Message	Possible cause	Suggested action
Alarm		
Unable to load configuration; using factory defaults.	A configuration load error occurred	Restore factory defaults. If the error persists, replace the main board.
Functional error. Call for service.	A critical configuration load error occurred	Replace the main board.
Information		
No connection for send.	The monitor is not configured to the network	In Advanced settings, touch the Data Management > Clinical Data tabs, then disable Automatically send on manual save if you only want to store readings on the device. If you want to send readings, then configure the device to the network.

Patient data management messages

Message	Possible cause	Suggested action
Alarm		
Maximum number of patient records saved. Oldest record overwritten.	The maximum number of patient records has been saved on the device	Go to the Review tab and delete old records to prevent the alarm from appearing when new records are saved.
Information		
No data saved.	No patient data is available	Take or enter vital signs before saving.
Patient ID required to save data.	The configuration requires a patient ID to save data	In Advanced settings, touch the Data management > Patient tabs, then disable Require patient ID to save readings .
Clinician ID required to save data.	The configuration requires a clinician ID to save data	In Advanced settings, touch the Data management > Clinician tabs, then disable Require clinician ID to save readings .
Patient ID required to send data.	The configuration requires a patient ID to send data	Add a patient ID.
Patient list is full. Delete some patients to add more.	The maximum number of patients was exceeded	Delete a patient from the list to add a new patient.
Stop intervals to select new patient.	The device is set to take interval readings	Stop intervals before changing the patient.
No connection for send.	No connectivity is available to support sending data manually or automatically sending data on manual save	Check the network connection. Check the Radio Configuration settings.
Unable to identify clinician.	The clinician ID or password is incorrect	Confirm the clinician ID and password (if applicable), and retry.
Unable to retrieve list.	The device is unable to retrieve a patient list from the network	Check the network connection. Check the Radio Configuration settings. Verify that the server is available.

Network messages

Message	Possible cause	Suggested action
Lost connectivity with host.	The central station or other host application has stopped running or is not operating properly	Confirm that the host application is running properly.
Failed to authenticate to server.	<p>Device is configured for server authentication, but server authentication failed for one of the following reasons:</p> <ul style="list-style-type: none"> the domain name of the server does not match the one reported in the server certificate the certificate is expired (no longer within the validity period) the certificate has not been verified the certificate has been revoked 	<p>Make sure server certificates are valid.</p> <hr/> <p>Make sure the correct CA certificate file exists on the device to authenticate the server certificate.</p> <hr/> <p>Check the server configuration. Make sure authentication is configured correctly.</p>
	The server is not configured for authentication	Disable the server authentication option on the device.

Disassembly and repair

This chapter is divided into two major subsections, defined in the table below.

Section A	Section B (IEC 60601 3rd- and 4th-edition compliant)
Devices meeting these criteria: <ul style="list-style-type: none"> • Manufactured before 11/2017* • MCE hardware version P3 or earlier (see the right pane on the Settings tab) <ul style="list-style-type: none"> • Built before serial number* 100023374817 	3rd-edition devices meeting these criteria: <ul style="list-style-type: none"> • Manufactured after 11/2017* • MCE hardware version P5 or later (see the right pane on the Settings tab) <ul style="list-style-type: none"> • Built after serial number* 100023374817 4th-edition devices meeting these criteria: <ul style="list-style-type: none"> • Manufactured after 12/2018**

* See "Device serial number and model label" in the Appendix for serial number format and meaning.

**See Customer Service Bulletin 80022414 CSB – CVSM/CIWS IEC 60601 4th Edition for the exact manufacturing cutoff and start dates as well as the serial number for the first 4th-edition device.

Examine your device to determine which subsection you should follow to complete disassembly and repair procedures.

This overview includes exploded views of the front exterior and rear interior that include callouts referencing the parts. These exploded views apply to both Section A and Section B, though certain parts are labeled as specific to one section or set of devices and not the other. In the instructions, numbers in parentheses refer to callouts in the exploded drawings. Except where otherwise noted, the reassembly procedure is the reverse of the disassembly procedure.

Each part's disassembly instructions may include one or both of the following subsections:

- **Reassembly notes:** This contains information specific to reassembly not addressed in the disassembly instructions, especially when reassembly is not a simple reverse of disassembly.
- **When replacing the component:** This contains information specific to installing a new option or replacement part.



WARNING Electrical shock hazard. Disconnect AC power before opening the device. Disconnect and remove the battery before opening the main chassis. Failure to do this can cause serious personal injury and damage to the device.



WARNING Risk of fire, explosion and burns. Do not short-circuit, crush, incinerate, or disassemble the battery pack.



WARNING Safety risk. Do not attempt to service the device when the device is connected to a patient.



CAUTION Before disassembling the device or installing options, disconnect the patient from the monitor, power down the device, disconnect the AC power cord and any attached accessories (SpO2 sensors, blood pressure hoses and cuffs, temperature probes, ECG modules, Braun docks, and barcode scanners) from the device.



CAUTION Remove the probe well in the temperature module prior to disassembly.



CAUTION Perform all repair procedures at a static-protected station.



CAUTION When the device case is opened, regard all parts as extremely fragile. Execute all procedure steps with care and precision.



CAUTION Observe screw torque specifications, especially with screws that secure directly into plastic standoffs.



CAUTION To avoid mismatching screws and holes, keep the screws for each piece with that piece as you remove modules and circuit assemblies. It is possible to mistakenly install machine screws in locations intended for plastite screws. Plastite screws in this device have a Torx-pan head.



CAUTION After performing any of these procedures and prior to returning the device to service, you must use the service tool, Gold licensed edition, to complete the full suite of functional tests to ensure that all systems are operating within the design specifications. For more information about these tests and the service tool, see "Functional verification and calibration."

If you do not have the service tool, contact Welch Allyn Technical Support.

For information about screws or connectors used in the device, see the Appendix.

Required tools and equipment

- #1 Phillips bit
- #2 Phillips bit
- #10 Torx bit
- Torque driver calibrated for 2.5 in-lb \pm 0.25 in-lb
- Torque driver calibrated for 6.0 in-lb \pm 1.0 in-lb
- Torque driver calibrated for 7.5 in-lb \pm 0.5 in-lb
- Slotted screwdriver
- Tweezers
- Needle-nose pliers
- Spudger
- Tie-wrap tool
- Tie-wrap cutter
- Soft lens wipes
- Scissors or other cutting device
- Canned air
- Adhesive tape
- Pro Gaff tape

For information about screws and connectors used in the device, see the Appendix.

Disassembly overview

The following chart provides an overview of the complete disassembly of the device. Most disassembly activities require that you complete a subset of the steps detailed here. The flow chart indicates the steps that must be completed in sequence to remove a particular component. Because a different sequence of preliminary steps might be required to remove certain components, you should use this flow chart as a reference at the start of every disassembly and component replacement procedure. A list of preliminary steps presented at the start of each disassembly topic provides the prerequisites for that disassembly task. (Some tasks in the flowchart are optional, depending on the scope of disassembly.)

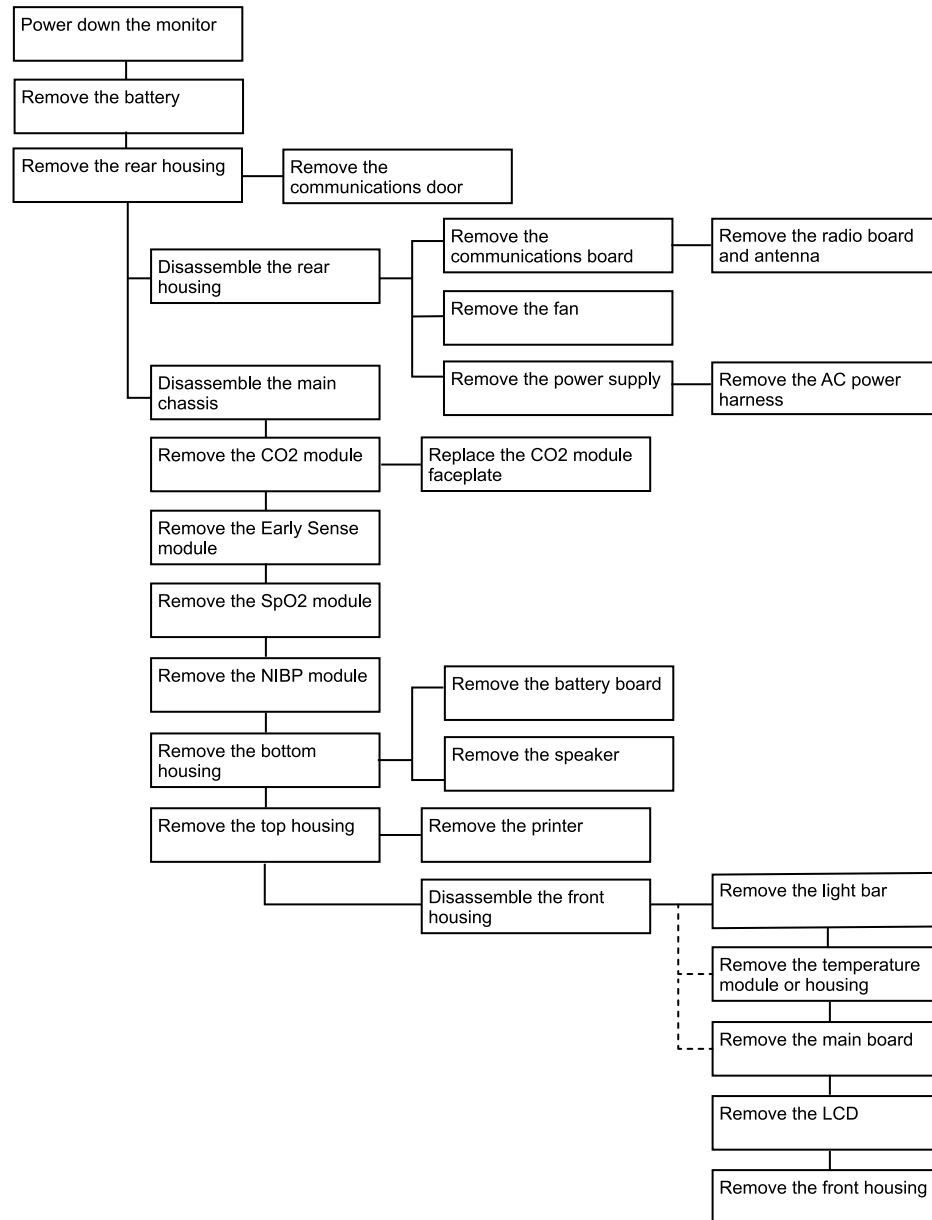

Section A

This section applies to devices manufactured before 11/2017, serial numbers before 100023374817, and MCE hardware version P3 or earlier.



NOTE If your device does not meet these criteria, see Section B for the correct disassembly and repair instructions.



NOTE See "Monitor serial number and model label" in the Appendix to learn how to determine the manufacture date from the serial number.

If the MCE hardware version is P2 or P3, DO NOT replace any components with service kits with the "3rd Ed" suffix. IEC 3rd Edition service kits are not compatible with hardware versions P2 and P3.

Service kits with the "4th Ed" suffix may be used on all devices running host software version 1.71.03 or 2.20.00 and later *with the exception of* 107124 (SERV KIT, CVSM, SpO2 MOD, NELLCOR 4th Ed). Use 107124 only on devices running host software version 2.41.xx or later.

Power down the device

You can power down the device as follows: 1) on devices with 2.X software, briefly press the power button on the housing and then following the onscreen prompts, or 2) on all devices, use onscreen controls alone.

Option 1. After the device is powered up, briefly press of the power button to open an onscreen dialog with the following options:

- **Power down.** Device behavior varies based on the active profile, whether or not patient trend data is stored, and whether or not patient context is established. While servicing the device, you need not be concerned about these details. They only matter to clinicians who are monitoring patients and storing patient data.
- **Sleep.** The Sleep button clears the display and puts the device into Display power-saving mode.
- **Cancel.** The Cancel button dismisses the dialog.

Touch **Power down** and complete the power-down procedure.

Option 2. To use onscreen controls alone to power down the device, follow these steps:

1. Touch the **Settings** tab.
2. Touch the **Device** tab.
3. Touch **Power down**.



NOTE The next three sections address disassembly and repair steps you can complete without removing the device from the wall or removing the battery. All steps presented after “Remove the system from the wall and remove the battery” require powering down as well as removing the device from the wall and removing the battery.

Exploded view, front exterior

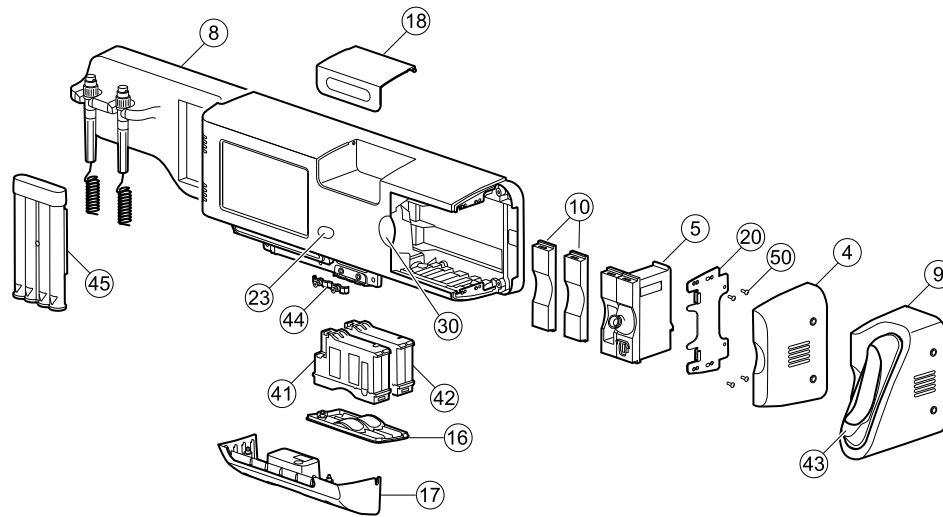

No.	Item	No.	Item
4	Side housing	23	Power button
5	SureTemp module	30	Blue insert
8	CIWS handle module assembly	41	NIBP module
9	Braun housing	42	SpO2 module
10	Platform module, blank	43	Braun dock
16	Module cover	44	Strain relief, comms, PW
17	Communications cover housing	45	Ear speculum dispenser, small
18	Cubby door	50	Screw, M3 x 0.5, Pan Phillips
20	Side mounting bracket/Module retaining plate		

Replace modules in the bottom housing

1. Power down the system and disconnect the AC power cord.
2. Disconnect the NIBP hose and the SpO2 cable if present.
3. Remove the communications cover housing.

Loosen the two captive screws using a #2 Phillips screwdriver to remove the communications cover.

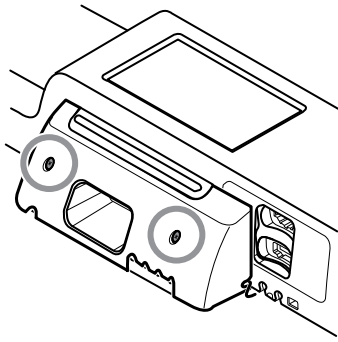

4. Remove the module cover.

Loosen the captive screw using a #2 Phillips screwdriver to remove the module cover.

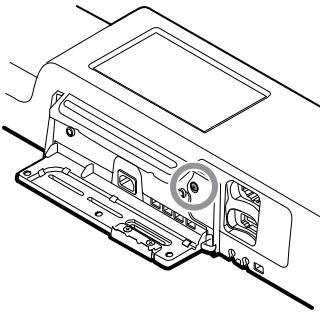

NOTE The modules fit tightly in the housing but can become loose over time. Support the modules to prevent them from falling out as you remove the module cover.

5. Remove the module you want to replace.

Slide the module out of the housing by inserting a finger in the slot at each end of the module and gently pull the module away from the housing until you completely remove it.

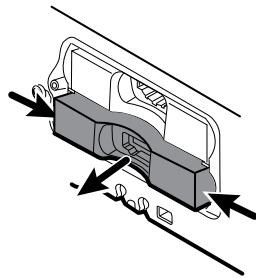

6. Disconnect the USB cable from the rear of the module.

Reassembly notes

- When aligning the module with the housing, the USB connection is on the left.
- The NIBP module must always be in the front-most slot.

Replace modules in the main housing



NOTE Check how the end cap or Braun thermometer housing are attached to the device. If bushings with captive screws attach the end cap or Braun thermometer housing to the side of the main housing as shown in step 1, proceed with the instructions as presented. If you don't see bushings with captive screws on the end cap or the Braun thermometer housing, then these parts are attached to the back of the chassis, not the right side. To remove these parts and access any front-facing modules, first remove the device from the wall. (See "Remove the system from the wall and remove the battery.")

1. Power down the system and disconnect the AC power cord.
2. Loosen the two captive #2 Phillips screws that hold the end cap or the Braun thermometer housing in place.

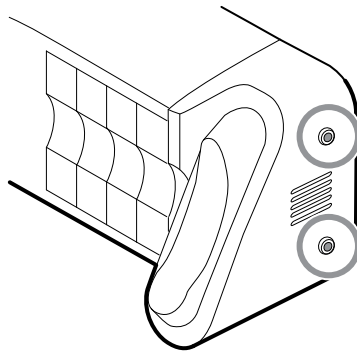

3. Remove the end cap or thermometer housing by sliding the piece away from the wall and then to the right.

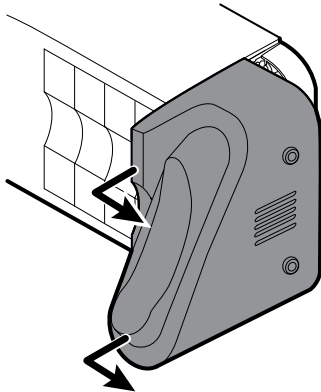

4. Disconnect the USB cable from the Braun dock, which you can access from the rear of the Braun housing.
5. Locate and remove the module retaining plate by removing the four #2 Phillips screws.

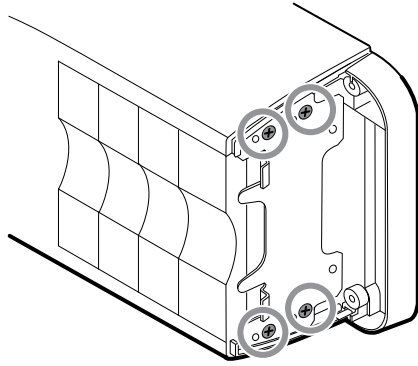

6. If SureTemp is installed, remove the module and the probe cover storage together, sliding them out the open end, and disconnect the USB cable.
7. Slide any blank face plates or modules to be removed toward the open end.



NOTE When removing any connected modules, disconnect the USB cables before you remove the module.



NOTE If you are replacing a Braun 4000 thermometer with a Braun 6000 thermometer, you must also replace the dock.

Remove the Braun dock from the housing

1. Hold the Braun housing with your right hand and the dock with your left hand as shown. With your right-hand fingers inside the housing, gently press the housing toward you and away from the dock. At the same time, gently push the dock away from you until the dock unsnaps from the housing.

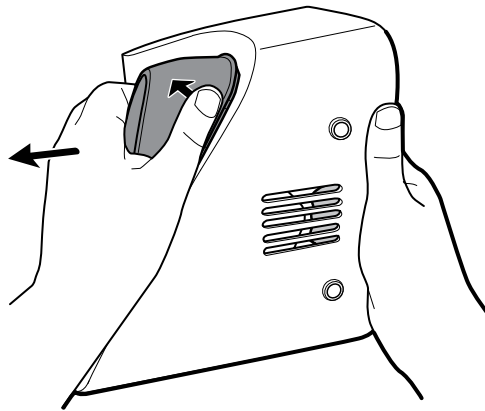

2. When the dock is completely loose, remove it from the housing.

Reassembly notes

- When aligning the module with the housing, the USB connection is on the bottom.
- The temperature module must always take up the last two spots closest to the end.
- The blank cover's beveled edge must be on the right when facing the device for proper alignment.

- When replacing the Braun dock, insert the bottom of the dock into the housing, align the molded ridges in the top of the dock with the slots in the top of the housing, and snap the dock into the housing.

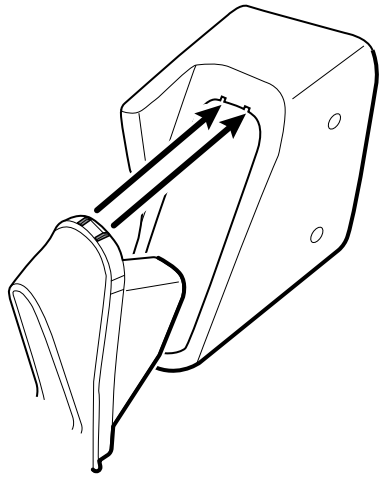

Remove the system from the wall and remove the battery

1. Power down the system and disconnect the AC power cord.
2. Disconnect any detachable sensors and cables:
 - Blood pressure cuffs and hoses
 - Temperature probes and cables
 - Braun thermometer
 - SpO2 sensors and cables
 - 3.5V instrument heads
3. Remove any items in the storage area and any other loose items before attempting to remove the system from the wall.
4. Close the storage area door and seal it with a piece of adhesive tape to prevent the door from opening.
5. Remove the speculum holder by lifting it up and away from the handle housing.

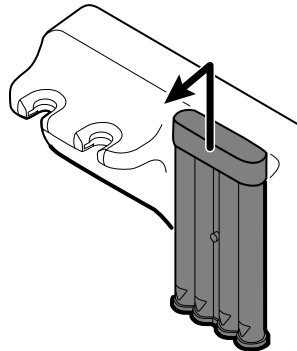

6. Remove the AC power cord.
7. Remove the communications connection cover.

Loosen the two captive screws, using a #2 Phillips screwdriver, until the cover is free from the housing.

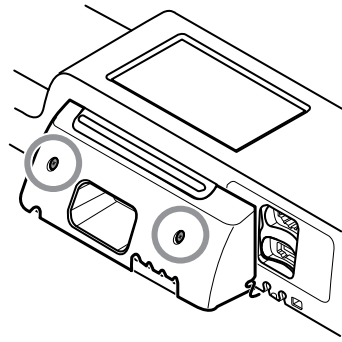

8. Remove the wall anchor screws using a #2 Phillips screwdriver.

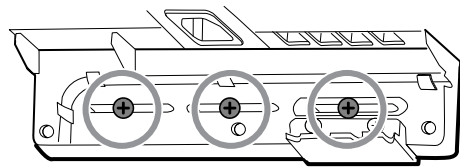

9. Hold the bottom and top of the system and push it up to remove the system from the wall mounting bracket.
10. Place the wall system on a table or flat work surface so that the back of the wall system faces up. Ensure that the display is protected from pressure or getting scratched.

11. Locate the battery, indicated by 
12. Remove the battery.

Remove the light-bar board

Complete the following preliminary steps:

- Power down the system and disconnect the AC power cord.
- Remove the system from the wall and remove the battery.

1. Remove the two torx screws from the light-bar cover.

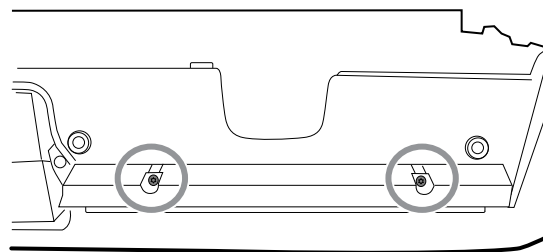

2. Remove the light bar and cover.

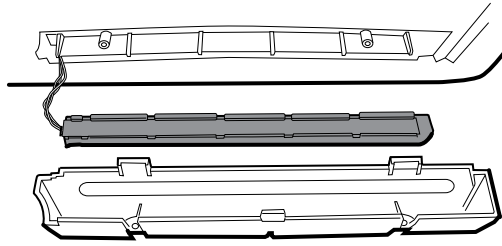

3. Remove the light bar from the light-bar cover.
4. Disconnect the light-bar harness from the light-bar board.

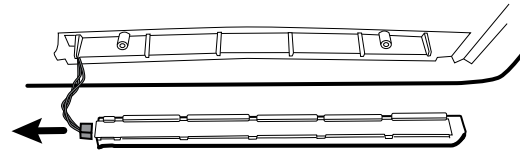

5. Remove the light-bar board from the light bar by sliding the board out from the connector end.

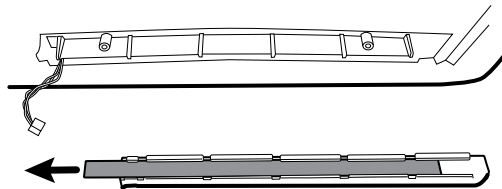

Reassembly notes

- Insert the light-bar board by placing the end without the connector into the open end of the light bar.
- Slide the light-bar board into the light bar until the connector end is flush with the end of the light bar.
- Feed the light-bar harness wires through the slot so they do not get pinched during reassembly.

Exploded view, rear interior

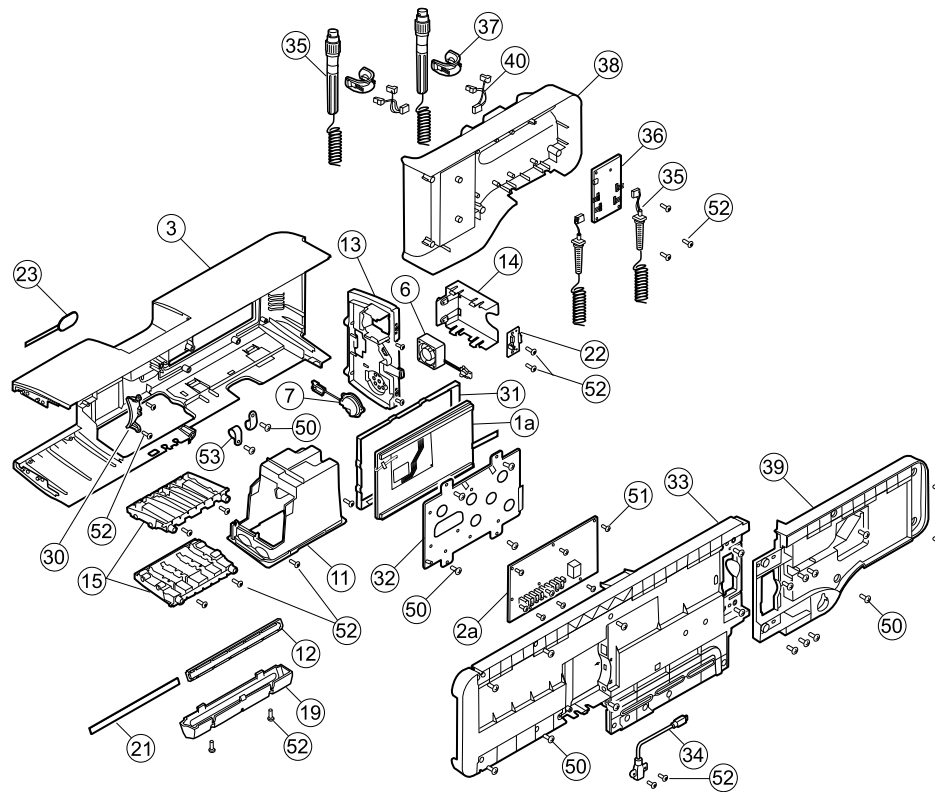

No.	Item	No.	Item
1a	LCD with touchscreen	31	LCD bezel
2a	Main board	32	LCD frame
3	Main housing	33	Chassis
6	Platform fan assembly	34	Cable, USB client
7	Platform speaker assembly	35	Handle assembly
11	Module well assembly	36	PCBA: Platform 767 controller, pattern E
12	Light bar	37	Handle, cradle, and opticals assembly, cool blue
13	Power panel	38	Housing, front handle
14	Battery housing	39	Housing, rear handle
15	Module track	40	IR connector and wire assembly
19	Light-bar cover	50	Screw, M4 x 10, Pan head with nyloc (Large Phillips screw)

No.	Item	No.	Item
21	Light-bar board	51	Screw, M3x0.5x8, Pan Phillips (Small Phillips screw)
22	Battery connector	52	Screw, Plastite #4-20 x .500 Pan head (Torx screw)
23	Power button and flex cable	53	CCH44-S10 P-clamp, 0.437
30	Blue insert		

Remove the handle module assembly

Complete the following preliminary steps:

- Power down the system and disconnect the AC power cord.
 - Remove the system from the wall and remove the battery.
1. Cut and remove the cable tie that holds the USB ferrite in place.

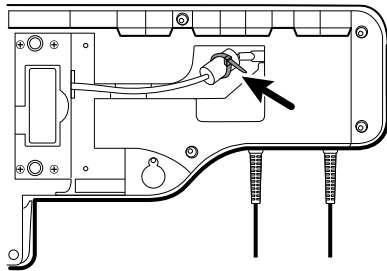

2. Disconnect the USB cable.
3. Remove the ferrite from the USB cable by pulling apart the two clips and lifting up.

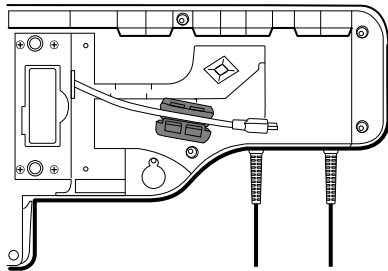

4. Remove the four large Phillips screws while supporting the end of the handle module assembly.

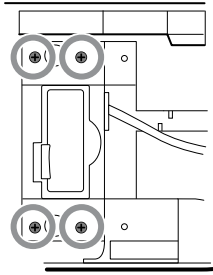

5. Lift the handle module assembly up and away from the main assembly while guiding the USB cable through the slotted opening.

Remove the handles

Complete the following preliminary steps:

- Power down the system and disconnect the AC power cord.
- Remove the system from the wall and remove the battery.
- Remove the handle module assembly.

1. Remove the six large Phillips screws on the back of the assembly, then lift and remove the rear handle housing.

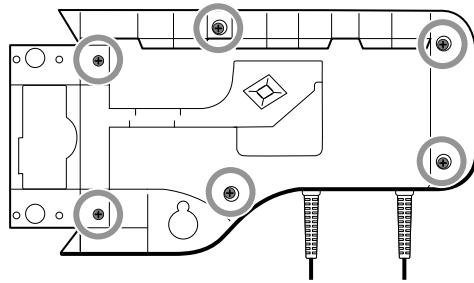

2. Disconnect the handle connector wires from the 767 Controller PCBA.

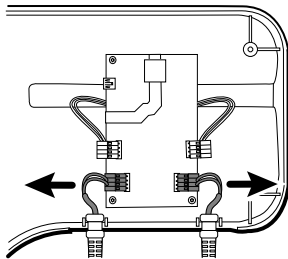

3. Lift and remove the handle cables from the front handle housing.

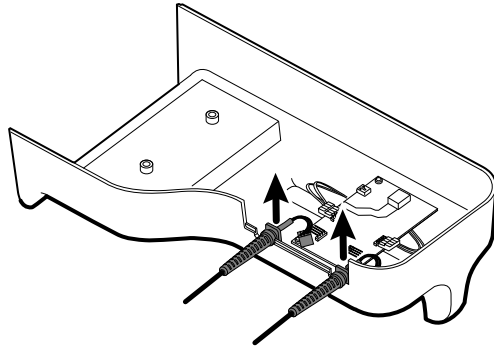

Reassembly note

When reconnecting the handle connection wires to the handle PCBA, the connecting wires must be facing up and away from the PCBA.

Remove the 767 controller PCBA

Complete the following preliminary steps:

- Power down the system and disconnect the AC power cord.
 - Remove the system from the wall and remove the battery.
 - Remove the handle module assembly.
 - Remove the handles.
1. Disconnect the two IR wire connectors from the handle PCBA.

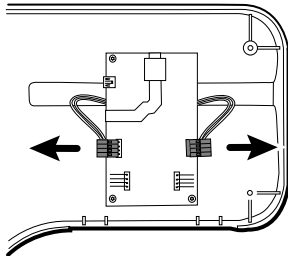

2. Remove the three Torx screws.

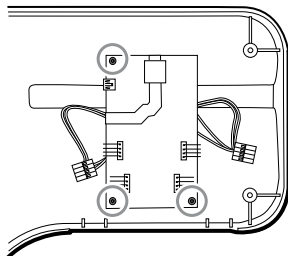

3. Lift and remove the PCBA.

Reassembly note

When reconnecting the IR wire connectors to the handle PCBA, the connecting wires must be facing down and toward the cradle assemblies.

Remove the handle cradle and optical assemblies

Complete the following preliminary steps:

- Power down the system and disconnect the AC power cord.
 - Remove the system from the wall and remove the battery.
 - Remove the handle module assembly.
 - Remove the handles.
 - Remove the 767 Controller PCBA.
1. On the rear of the assembly, disconnect both IR wires from the optical sensors.

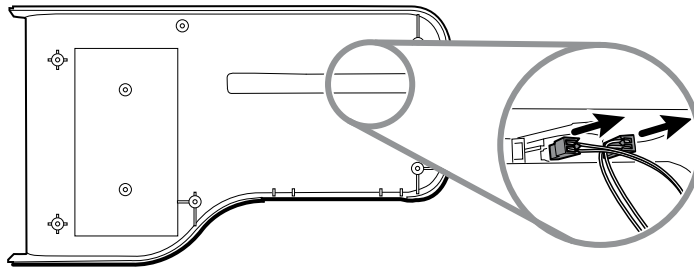

2. Push in the snap tabs and remove the cradle assembly by pushing outward.

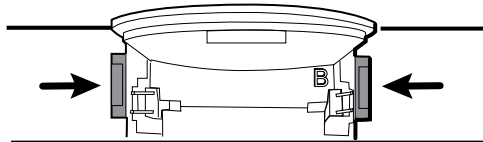

Reassembly notes

- For ease of assembly, connect the IR wire assemblies to the optical sensors before attaching the handle cradle to the handle assembly housing.
- Attach the connector with the black and white wires to the optical detector (indicated by the letter "B" molded into the cradle plastic). Attach the connector with the red and white wires to the optical emitter. The wires should face inward once the handle cradle is assembled.

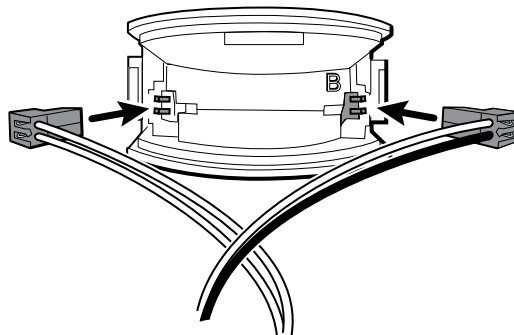

- Snap the handle cradle assembly into the front housing. Make sure that the cradle assembly tab and the beveled edge are at the top of the housing.

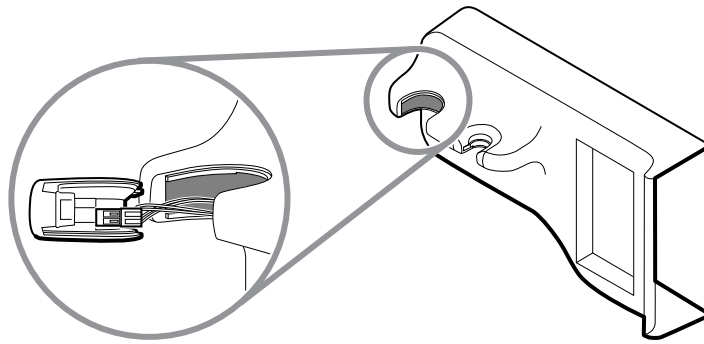

Open the chassis

Complete the following preliminary steps:

- Power down the system and disconnect the AC power cord.
- Remove the system from the wall and remove the battery.
- Remove the handle module assembly.
- If the Braun option is accessible from the side, remove it as described in "Replace modules from the main housing."

1. Complete one of the two substeps below based on your system details.

- **For systems built before July 15, 2011 with the Braun thermometer option or end cap mounted to the rear chassis:**
 - a. Remove the 6 screws as shown.

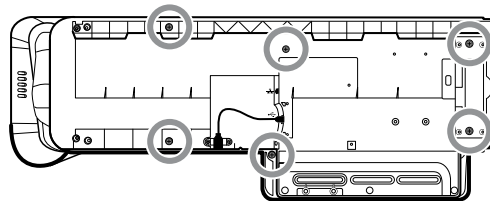

- b. Disconnect the USB cable from the rear of the Braun housing.
- c. Remove the two large Phillips screws that hold the end cap or the thermometer housing in place, and remove the end cap or thermometer housing.

- **For systems built after July 15, 2011 with the Braun thermometer option or end cap mounted to the side mounting bracket:**
 - a. Remove the Braun module if present as described in "Remove modules from the main housing."
 - b. Remove the 8 screws as shown.

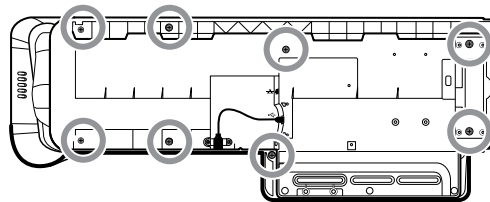

2. Remove the two Torx screws securing the client USB connector to the housing, and then disconnect and remove the cable.

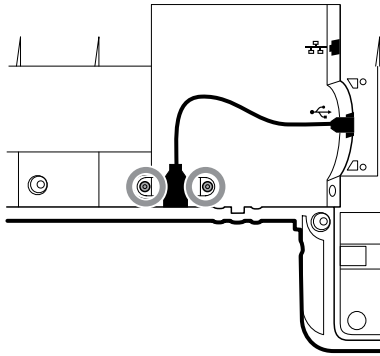

CAUTION Multiple wire connections are still connected between the front housing and the chassis. These must be disconnected before it is safe to completely separate the two pieces.

- Carefully lift the top of the chassis away from the front housing while leaving slack in all cable connections.

From the communications board, disconnect the following in the order presented:

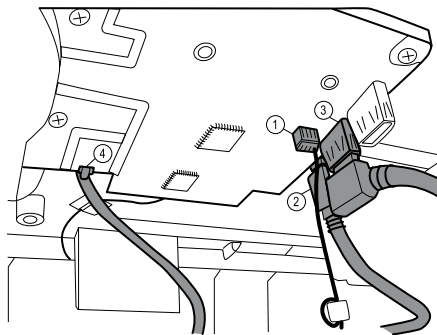

Number	Item
1	Small 4-pin connector
2	Mini USB cable
3	USB cable
4	Ethernet cable

- Disconnect the power supply cable from the power supply.

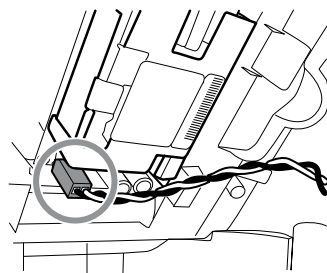

- Separate the chassis from the front housing.

Exploded view, chassis

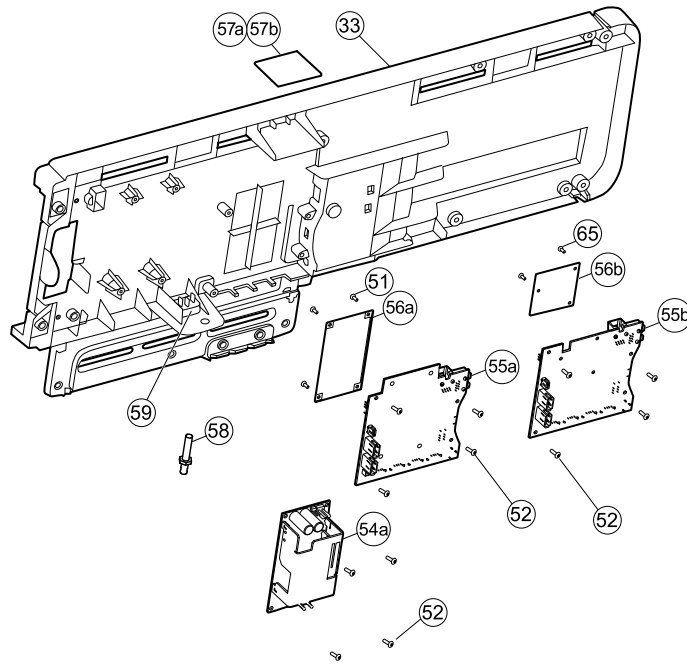

No.	Item	No.	Item
33	Chassis	56b	Radio board (Newmar)
51	Screw, M3x0.5x8, Pan Phillips (Small Phillips screw)	57a	Antenna board (Lamarr)
52	Screw, Plastite #4-20 x .500 Pan head (Torx screw)	57b	Antenna board (Newmar)
54a	Power supply, 60W	58	Ground lug
55a	Communications board (Lamarr)	59	IEC connector
55b	Communications board (Newmar)	65	Screw, M2 x 6, Pan head
56a	Radio board (Lamarr)		

Remove the power supply

Complete the following preliminary steps:

- Power down the system and disconnect the AC power cord.
 - Remove the system from the wall and remove the battery.
 - Remove the handle module assembly.
 - Open the chassis.
1. Disconnect the green ground cable and the AC power harness from the power supply.

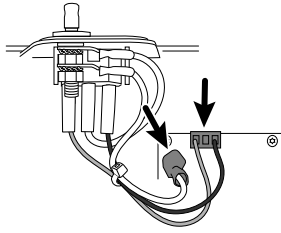

2. Remove the four torx screws.

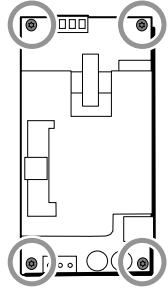

3. Remove the power supply.

Reassembly note

When reinstalling the power supply, orient the board so that the end of the board with the AC-to-power-supply (J1) connection is closest to the IEC connector.

Remove the ground lug, AC power harness assembly, and IEC connector



NOTE Do not disconnect the AC power harness from the IEC connector unless you are replacing it. Once you disconnect the AC power harness, you cannot reuse it.

Complete the following preliminary steps:

- Power down the system and disconnect the AC power cord.
 - Remove the system from the wall and remove the battery.
 - Remove the handle module assembly.
 - Open the chassis.
1. Disconnect the AC power harness and ground from the power supply.

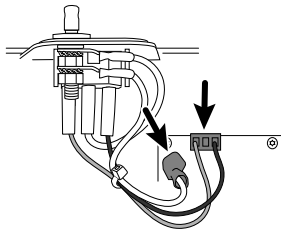

2. To remove the ground lug:

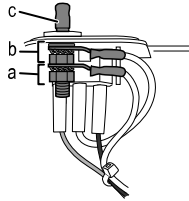

- a. Remove the 10mm hex nut and slide out the star lock washer and the ground wire (power supply) ring terminal.
 - b. Remove the next 10 mm hex nut and slide out the star lock washer, the ground wire (mains) ring terminal, and the flat washer.
 - c. Remove the bare ground lug by pulling it out from the outside of the chassis.
3. To remove the IEC connector:
- a. Disconnect the three power wires: blue neutral (N), green ground (G), and brown line (L).

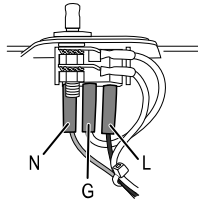

NOTE You must now replace the AC power harness. It cannot be reused.

- b. Push in on the three plastic release tabs to release the IEC connector.

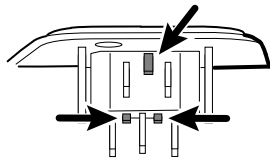

Remove the communications board

Complete the following preliminary steps:

- Power down the system and disconnect the AC power cord.
- Remove the system from the wall and remove the battery.
- Remove the handle module assembly.
- Open the chassis.

1. Disconnect the mini-USB connection on the outside of the chassis.

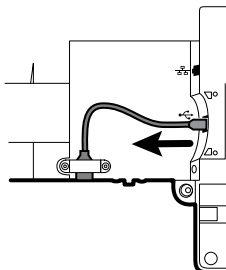

2. Turn over the chassis to access the communications board.

- Remove the four Torx screws.

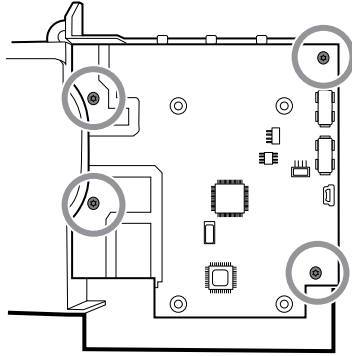

- Lift the communications board from the chassis.
- For systems with the radio option, remove the tape securing the antenna cable to the chassis, and rotate the communications board counter-clockwise to clear the chassis. Make sure not to pull on the antenna cable. Turn the board over and place it inside the chassis.

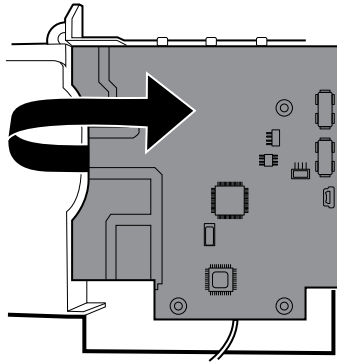

- If replacing the communications board, remove the radio board as described in "Remove the radio board and antenna."

Remove the radio board and antenna



NOTE Do not remove the antenna board from the chassis unless you are replacing the radio and/or the antenna and/or the chassis.

Complete the following preliminary steps:

- Power down the system and disconnect the AC power cord.
- Remove the system from the wall and remove the battery.
- Remove the handle module assembly.
- Open the chassis.
- Remove the power supply.
- Remove the ground lug, AC power harness, and IEC connector.
- Remove the communications board.

- Remove the radio board:
 - Turn the communications board over to access the radio board, taking care to avoid straining the antenna cable.
 - If the original Lamarr radio (a/b/g band) is installed, remove the four small Phillips (machine) screws securing the radio board to the communications board, as shown on the left. If the Newmar radio (a/b/g/n band) is installed, remove the three small Phillips

(machine) screws securing the radio board to the communications board, as shown on the right.

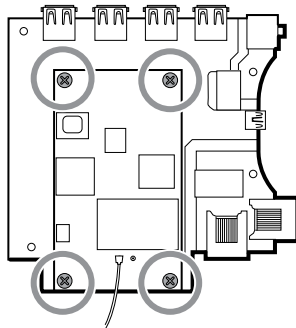
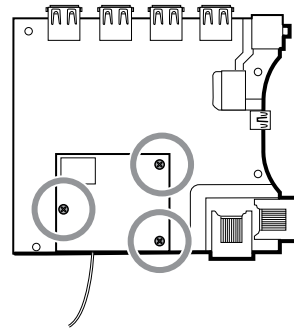
Lamarr**Newmar**

- c. Hold the communications board with one hand while grasping the radio board at the opposite end from the antenna connection and pull the radio board away from the communications board.
2. Remove the antenna and antenna cable.

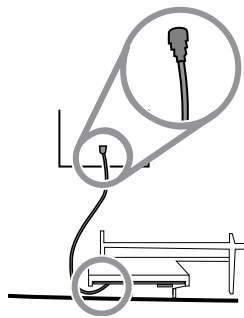

- a. Carefully disconnect the antenna cable by lifting up on the wire neck just before the connection point.
- b. Use a soft tool such as a spudger to separate the adhesive from the inside of the chassis of the antenna plate.

Reassembly notes

If the antenna is removed:

- Clean the chassis and mounting surface with 70 percent isopropyl alcohol.
- Peel the backing off the double-stick tape and affix it to the chassis antenna plate.
- Mount the antenna to the antenna plate. Make sure the PG terminal on the antenna board is facing outwards.

Antenna cable connection:

- The following illustration shows both Lamarr and Newmar radio and antenna boards. The instructions for both sets of boards is the same. Attach the antenna cable to terminal G on the radio board. Attach the other end of the cable to the antenna on terminal PG.

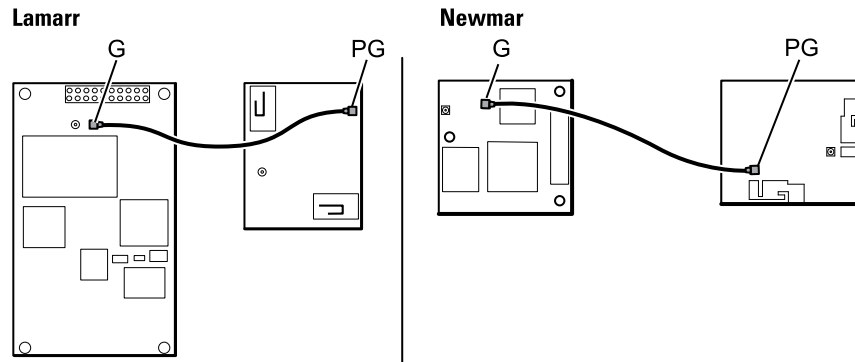

- Once the antenna, radio, and communications board are mounted and secure, secure the antenna cable to the housing with Pro Gaff tape.

Replace the chassis

Complete the following preliminary steps:

- Power down the system and disconnect the AC power cord.
- Remove the system from the wall and remove the battery.
- Remove the handle module assembly.
- Open the chassis.
- Remove the power supply.
- Remove the communications board.
- For systems with the radio option, remove the radio board and antenna.

Remove the USB client cable from the outer side of the chassis by removing the two Torx screws.

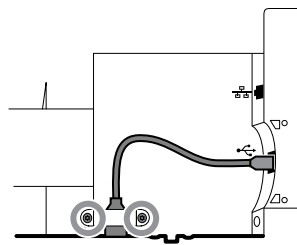

Disconnect or remove the light bar

Complete the following preliminary steps:

- Power down the system and disconnect the AC power cord.
 - Remove the system from the wall and remove the battery.
 - Remove the handle module assembly.
 - Open the chassis.
1. Remove the two Torx screws from the light-bar cover.

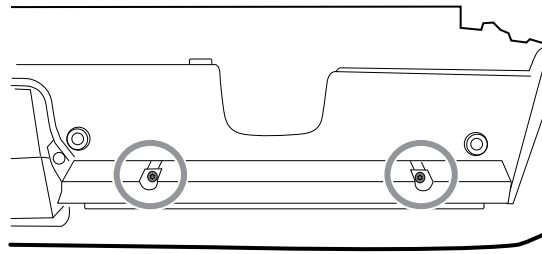

- Remove the light bar and cover.

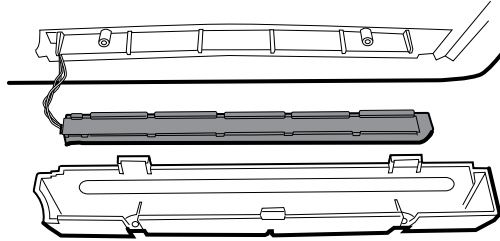

- Remove the light bar from the light-bar cover.
- Disconnect the light-bar harness from the light-bar board.

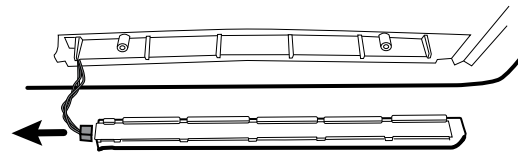

- If replacing the light-bar board, remove the light-bar board from the light bar by sliding the board out from the connector end.

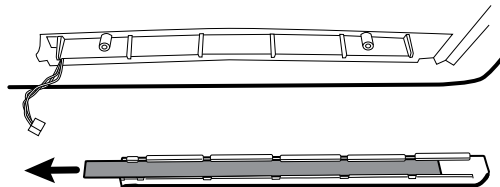

Reassembly notes

- Insert the light-bar board by placing the end without the connector into the open end of the light bar.
- Slide the light-bar board into the light bar until the connector end is flush with the end of the light bar.
- Feed the light-bar harness wires through the slot so they do not get pinched during reassembly.

Disconnect or remove the fan

Complete the following preliminary steps:

- Power down the system and disconnect the AC power cord.
- Remove the system from the wall and remove the battery.
- Remove the handle module assembly.

- Open the chassis.
1. Disconnect the power cable from the fan harness connector.

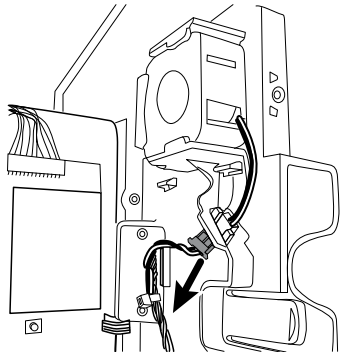

2. Press the flanges on the sides of the fan harness connector and separate the fan connector from the power panel.

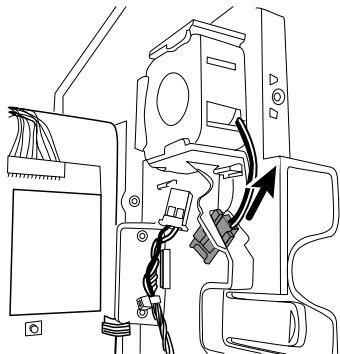

3. If you are removing the fan, slide the fan up and remove.

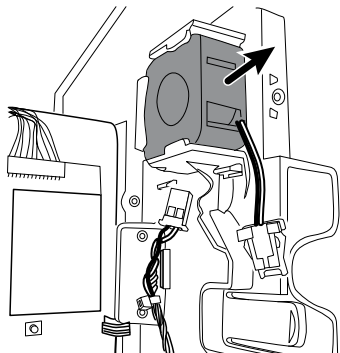

Reassembly note

Install the fan with the label facing the power panel.

Disconnect or remove the power panel

Complete the following preliminary steps:

- Power down the system and disconnect the AC power cord.
- Remove the system from the wall and remove the battery.
- Remove the handle module assembly.
- Open the chassis.

- Remove the fan.
1. If you haven't done so already, disconnect the power cable from the fan harness connector.

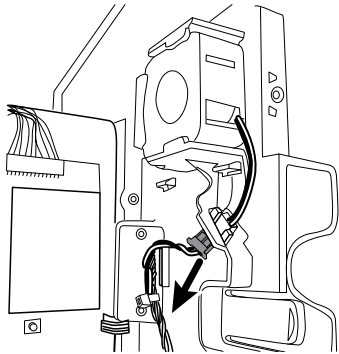

2. Disconnect the two harness connectors from the battery board.

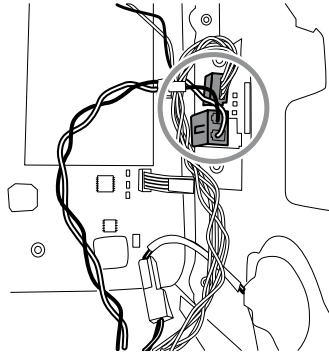

3. Disconnect the speaker connector wire.

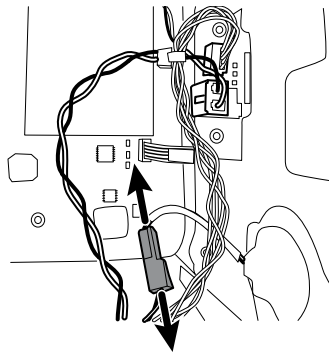

4. Remove the two Torx screws that attach the power panel to the front housing and slide the power panel out of the housing.

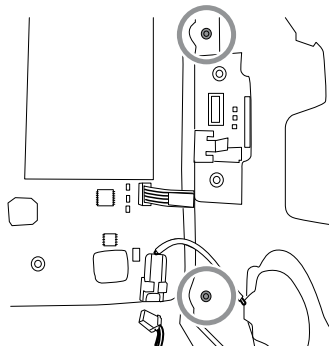

5. Pull the module handle assembly USB cable through the access hole in the power panel.

Reassembly notes

- Pull the module handle assembly USB cable through the access hole in power panel before securing the power panel to the housing.
- When installing the power panel in the housing, do not obstruct the channel or allow the battery board or battery housing to push the LCD flex sideways.
- Reconnect the speaker, battery board, and fan harnesses.

Remove the speaker

Complete the following preliminary steps:

- Power down the system and disconnect the AC power cord.
 - Remove the system from the wall and remove the battery.
 - Remove the handle module assembly.
 - Open the chassis.
 - Remove the power panel.
1. Carefully pry the speaker and adhesive away from the power panel.
 2. Remove any remaining gasket material and clean the surface with 70 percent isopropyl alcohol.
 3. Remove the paper on the speaker to expose the adhesive on the gasket.
 4. Apply pressure to the outer radius of the speaker assembly to assure good adhesion with the power panel.

Replace the battery board

Complete the following preliminary steps:

- Power down the system and disconnect the AC power cord.
 - Remove the system from the wall and remove the battery.
 - Remove the handle module assembly.
 - Open the chassis.
 - Remove the power panel.
1. Remove the battery compartment from the power panel by pushing in on the four plastic tabs.

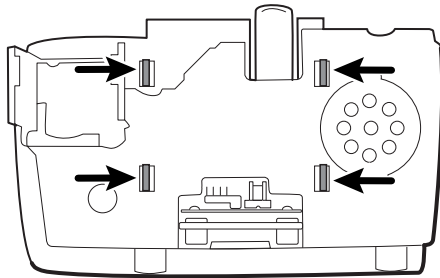

2. Remove the two Torx screws from the battery compartment and remove the battery board.

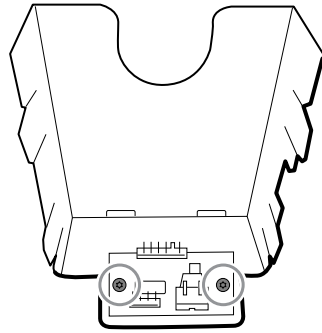

- Secure the new battery board to the battery compartment with two Torx screws.

Disconnect or remove the power wire harness and main wire harness



NOTE If removing the main board or LCD, it is not necessary to cut wire ties attaching the harness to the housing unless you are replacing the harness or the housing.



NOTE When replacing the main harness, you must disconnect the light-bar board from the main harness.

Complete the following preliminary steps:

- Power down the system and disconnect the AC power cord.
 - Remove the system from the wall and remove the battery.
 - Remove the handle module assembly.
 - Open the chassis.
- Disconnect the USB connections from the main board in positions 1 through 8 and 10 and 11. Remove the USB cables from the cable separator to clear the work area.

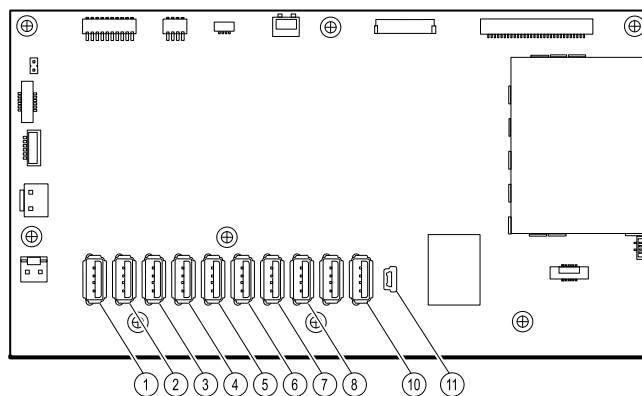

- Disconnect the connectors as follows:
 - To disconnect the power harness, disconnect the connectors at J29 and J30.
 - To disconnect the main harness, disconnect the connectors at J34, J12, J49, J46, and J45.

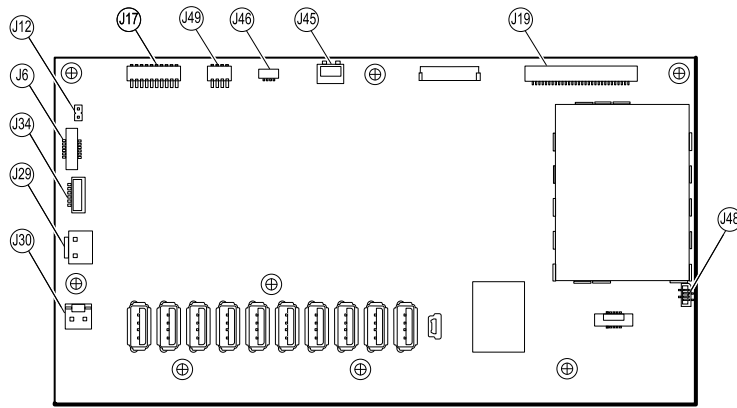

3. If you are replacing the power harness, carefully cut the two wire ties and remove the harness.
4. If you are replacing the main harness, disconnect the main harness from the power panel, carefully cut the two wire ties, and remove the harness.

Reassembly notes

When replacing the harness standoff:

- Orient the harness standoff so that the main harness communications power, light bar, and fan wires run parallel to the top of the main board.
- Mount the harness standoff to the frame, aligning the edge of the standoff with the edge of the main board directly beneath the screw and securing the upper left-hand corner of the frame.

When replacing the main harness:

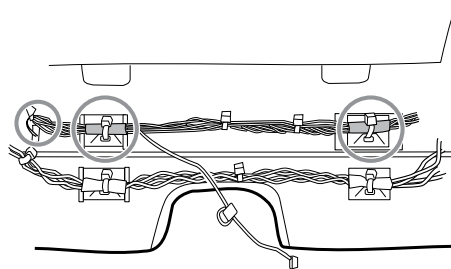

- Align the shrink-wrapped sections and their wire tie anchors with the light-bar wires on the left.
- Feed the light-bar wires through the rectangular opening in the bottom of the housing to the right of the module well.
- Attach the harness to the main housing using the wire tie anchors closest to the display or front of the housing.

When replacing the power harness:

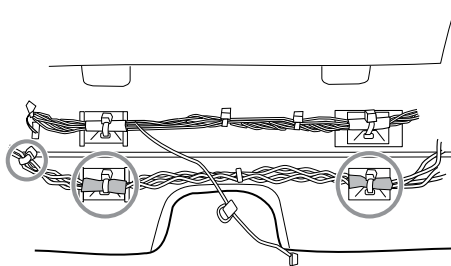

- Align the shrink-wrapped sections with the wire tie anchors.
- Align the end with the wire tie closest to the end on the left to connect with the main board.
- Attach to the main housing using the wire tie anchors closest to the back of the housing.
- Route the connections from the main harness to the main board (communications power, light bar, fan) **over** the last USB cable, **under** the remaining USB cables, and **through** the harness standoff. Twist to lock the harness in the standoff.

Remove the main board

Complete the following preliminary steps:

- Power down the system and disconnect the AC power cord.
- Remove the system from the wall and remove the battery.
- Remove the handle module assembly.
- Open the chassis.
- Disconnect the power wire harness and the main harness.

1. Disconnect the following on the main board:
 - a. The power button flex cable at J6.
 - b. The LCD harness at J19.
 - c. The LCD flex cable at J48.

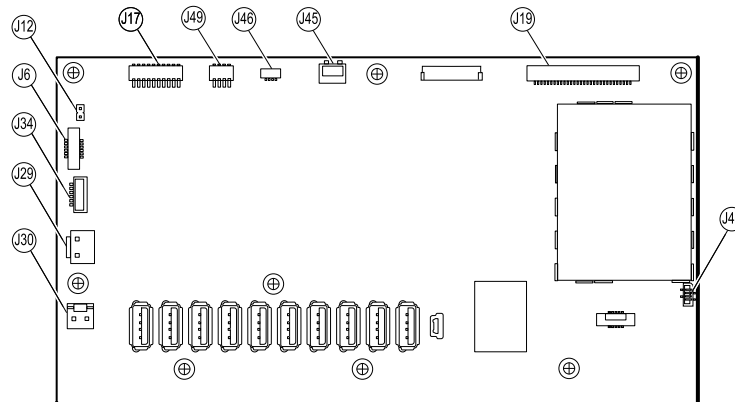

2. Remove the Ethernet cable:
 - a. Disconnect the Ethernet cable from the Ethernet cable connector at J11 on the main board.
 - b. Remove the screw that secures the Ethernet cable P-clamp to the main board.
 - c. Remove the Ethernet cable.

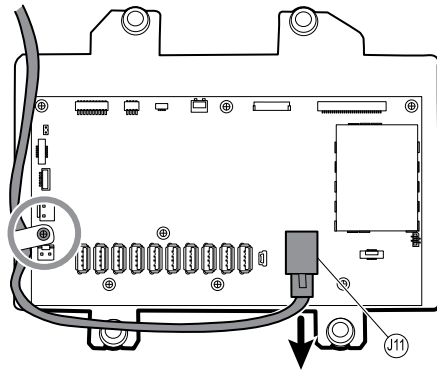

3. Remove the seven small Phillips screws that secure the main board to the LCD frame.

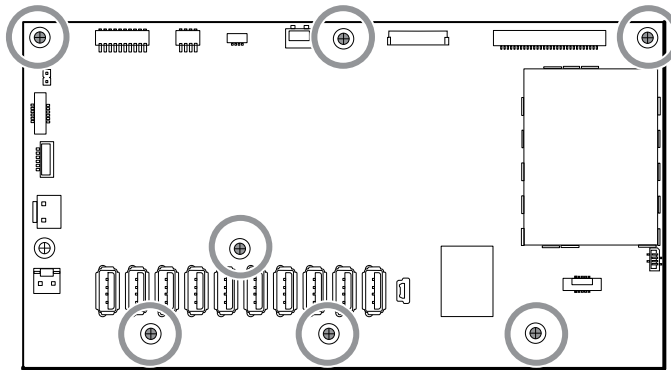

4. Remove the main board.

Reassembly notes

- Ensure that the LCD flex cable is not under the main board.



CAUTION The solder joint of the LCD connector (J48) is fragile. When inserting or removing the flex cable, do not stress the solder joint.

- Route the Ethernet cable outside the PEM stud and not underneath the main board.
- Connect the Ethernet cable to the main board:
 - Verify whether your model contains PCBA 407574 revision B, C, or D. Revisions B and C have no logo on the top surface of the Ethernet port. Revision D has a logo on the top surface of the Ethernet port. See the figure below.
 - For PCBA 407574 revisions B and C, confirm that the Ethernet cable has a shim on one connector. Insert the connector with the shim into the Ethernet port.
 - For PCBA 407574 revision D, you can use either an Ethernet cable with a shim or an Ethernet cable without a shim. Insert the connector into the Ethernet port.

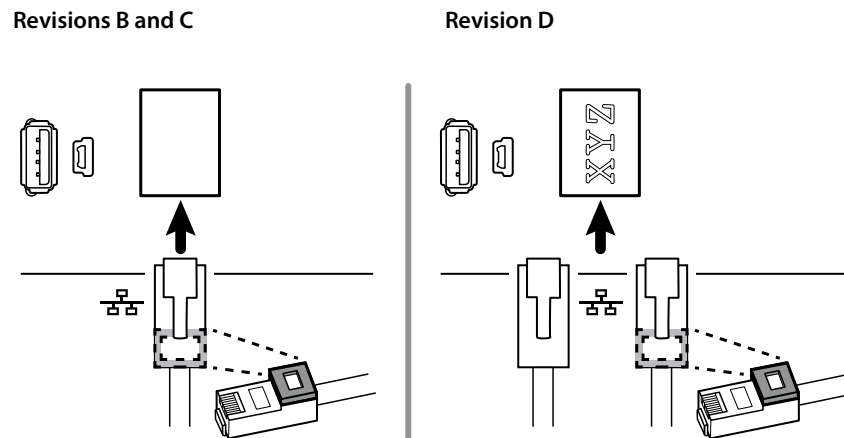

- When securing the main board, install the screw near J30 **after** you install the Ethernet cable.
- If the light bar is not installed, install the light-bar harness into the housing, positioning the ferrite bead near the main board.

When replacing the main board

- When ordering the replacement main board, order the standard license for the model being serviced. You will receive an authorization code to enter in the service tool to reactivate the licenses included with the original configuration.
- Before installing the main board, record the serial number of the main board.
- After reassembling the system, use the service tool to provision the system as follows:
 - Enter the device's serial number. This can be found on the bottom of the device.
 - Enter the main board (host controller) serial number.
 - Select the Connex Integrated Wall System from the device model dropdown menu.
 - Restore any previously licensed features by entering the authorization code in the service tool. Use the authorization codes that accompanied the replacement board, along with any additional license authorization codes previously installed. Record the device serial number on the license authorization code cards received with the replacement board and retain for future use. If the license is lost, you can reuse the authorization code on the same device.
 - Update the host controller software to the current version or version in use at your facility. If the required version of the host software is not available after connecting the device to the service tool, contact Welch Allyn Technical Support.

Remove the LCD

Complete the following preliminary steps:

- Power down the system and disconnect the AC power cord.
- Remove the system from the wall and remove the battery.
- Remove the handle module assembly.
- Open the chassis.
- Disconnect the power wire harness and the main harness.
- Remove the main board.



NOTE Do not remove the LCD harness from the frame unless you are replacing the harness or frame.

1. Remove the tape and disconnect the LCD harness from the LCD. For easier access to the connector, you can slide the ferrite bead closest to the connector up the harness.
2. Remove the four large Phillips (shoulder) screws that secure the LCD frame.

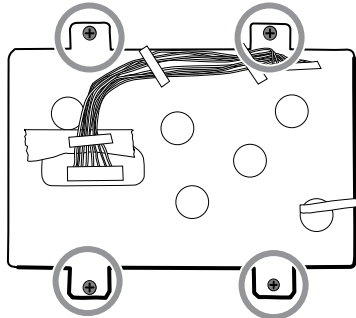

3. Remove the LCD frame.



NOTE Be sure to support the LCD if you are removing it with the frame. The foam strips on the LCD might cause the LCD to stick to the frame.

4. Remove the LCD.

Reassembly notes

- Ensure that the LCD flex cable is not under the LCD frame.



CAUTION The solder joint of the LCD connector (J48) is fragile. When inserting or removing the flex cable, do not stress the solder joint. Do not cause creases that may break the connections.

- Insert the display into the bezel in the front housing with the LCD flex cable on the lower right as shown. Verify that the LCD flex cable feeds through the bezel's clearance feature. (The image on the left applies to older displays while the one on the right applies to newer displays.)

1st generation displays

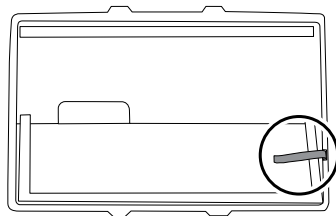

2nd generation displays

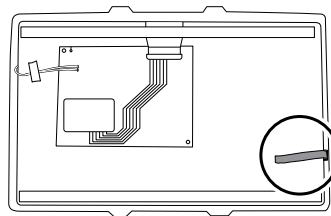

- Place the LCD frame over the LCD. Verify that the LCD frame does not cover the LCD flex cable.

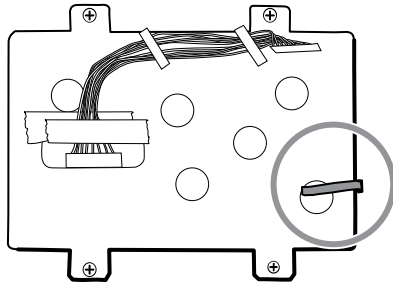

- Center the LCD and bezel in the main housing's molded channel with the bottom near the screw bosses.
- Replace the Pro Gaff tape in the frame opening under the display harness as shown.
- After connecting the display harness to the LCD, secure the harness to the LCD frame with Pro Gaff tape as shown.

When replacing the LCD frame

- Install a 3-inch strip of Pro Gaff tape over the top part of the LCD harness cutout to protect the LCD harness from abrasion.

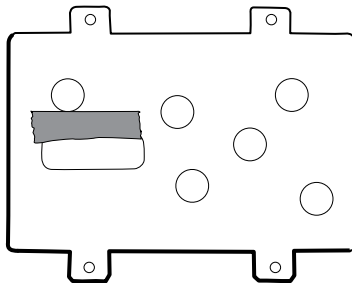

- Install the LCD harness. Use isopropyl alcohol to clean the area in the scribed boxes where you will mount the harness's ferrite beads. Expose the sticky backing on the ferrite beads and mount them in the scribed rectangles.



NOTE If you don't place the ferrites correctly in marked areas, they will obstruct the placement of other components like the MCE board.

- Replace the Pro Gaff tape in the frame opening under the display harness.
- After connecting the display harness to the LCD, secure it to the LCD frame with Pro Gaff tape as shown.

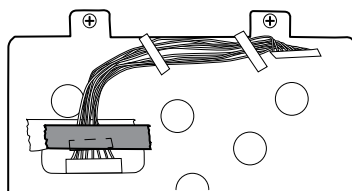

- After reconnecting the main harness, mount the harness standoff to the frame (see main harness reassembly notes).

When replacing the LCD

- Peel the protective sheet from the LCD.
- Verify that the foam strips are installed on the back of the LCD near the top and bottom edges. On 1st generation displays (see image on the left), the foam strip extends halfway up from the bottom on both sides of the LCD. On 2nd generation displays, the foam strips are only on the top and bottom of the LCD (see image on the right).

1st generation displays

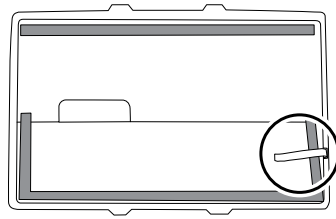

2nd generation displays

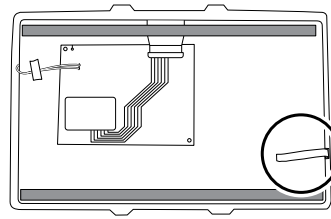

- Verify that the LCD flex cable feeds through the bezel's clearance feature.
- Insert the LCD into the bezel in the front housing with the LCD flex cable on the lower right as shown.

Remove modules in the bottom housing



NOTE These instructions are similar to "Replace modules in the bottom housing" presented earlier, but this topic assumes that you are not simply replacing the modules. Instead, you have taken the wall system off the wall and are removing modules to replace the power button or the front housing. If you have already removed these modules, proceed to "Remove the module well." Otherwise, choose one of the two following options:

Option 1. Complete the following preliminary steps if your goal is to replace the front housing:

- Power down the system and disconnect the AC power cord.
- Remove the system from the wall and remove the battery.
- Remove the handle module assembly.
- Open the chassis.
- Remove the light bar.
- Remove the power panel.
- Remove the power wire harness and the main wire harness.

Option 2. Complete the following preliminary steps if your goal is to replace the power button:

- Power down the system and disconnect the AC power cord.
 - Remove the system from the wall and remove the battery.
 - Remove the handle module assembly.
 - Open the chassis.
1. Power down the system and disconnect the AC power cord.
 2. Disconnect the NIBP hose and the SpO2 cable if present.
 3. Remove the communications cover housing.

Loosen the two captive screws using a #2 Phillips screwdriver to remove the communications cover.

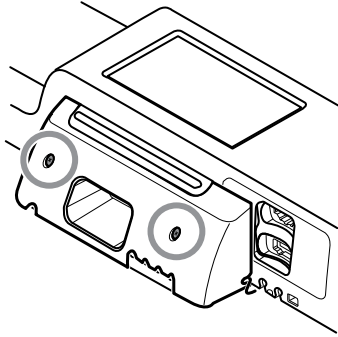

4. Remove the module cover.

Loosen the captive screw using a #2 Phillips screwdriver to remove the module cover.

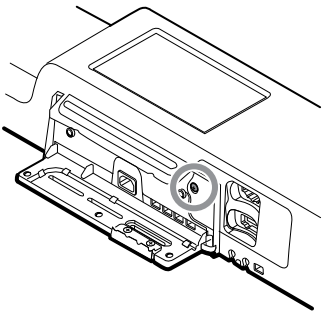

NOTE The modules fit tightly in the housing but can become loose over time. Support the modules as you remove the module cover.

5. Remove the modules.

Slide each module out of the housing by inserting a finger in the slot at each end of the module and gently pull the module away from the housing until you completely remove it.

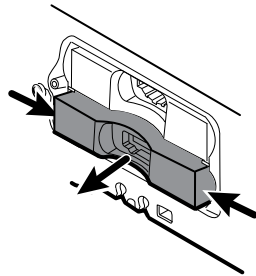

6. Disconnect the USB cables from the rear of each module.

Reassembly notes

- When aligning the module with the housing, the USB connection is on the left.
- The NIBP module must always be in the front-most slot.

Remove the module well

Option 1. Complete the following preliminary steps if your goal is to replace the front housing:

- Power down the system and disconnect the AC power cord.
- Remove the system from the wall and remove the battery.
- Remove the handle module assembly.
- Open the chassis.
- Remove the light bar.
- Remove the power panel.
- Remove the power wire harness and the main wire harness.
- Remove the modules in the bottom housing.

Option 2. Complete the following preliminary steps if your goal is to replace the power button:

- Power down the system and disconnect the AC power cord.
- Remove the system from the wall and remove the battery.
- Remove the handle module assembly.
- Open the chassis.
- Remove the modules in the bottom housing.

1. Disconnect the USB cables from the connectors on the main board in positions 6 and 7.

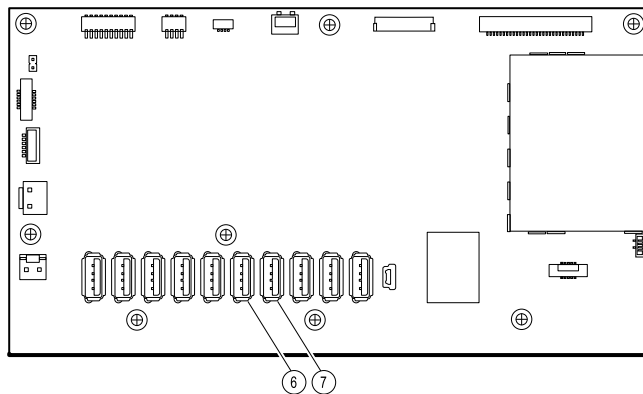

2. Remove the Torx screws on both sides of the module well.

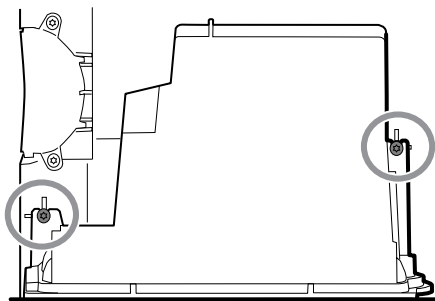

3. Remove the module well from the front housing. Remove the attached USB cables if necessary.

Reassembly notes

- Route USB cables properly:

- Route cables through the module well to the correct corresponding module.
- Route the NIBP and SpO2 USB cables over the Ethernet cable.
- Connect USB cables properly:
 - The NIBP module must be connected to USB position 7 on the main board.
 - The SpO2 module must be connected to USB position 6 on the main board.

Module USB connectors

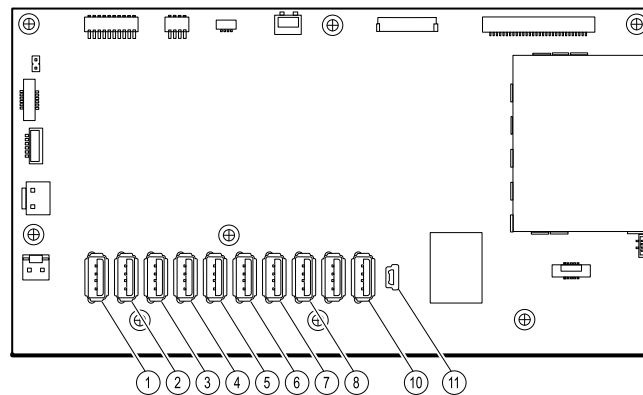

USB slot	Material number	Connection
1	715891	MCE to modules—Braun if installed
2	715891	MCE to modules
3	715891	MCE to modules
4	715891	MCE to modules
5	715891	MCE to modules
6	715891	MCE to SpO2
7	715891	MCE to NIBP
8	712980	MCE to communications board
9	n/a	none
10	715891	MCE to handle module PCBA
11	713282	MCE to communications

Replace the power button

Complete the following preliminary steps:

- Power down the system and disconnect the AC power cord.
- Remove the system from the wall and remove the battery.

- Remove the handle module assembly.
 - Open the chassis.
 - Remove the modules in the bottom housing.
 - Remove the module well.
1. Disconnect the power button flex cable from the main board at J6.
 2. Peel off and discard the power button from the front housing.
 3. Thoroughly clean the housing surface with isopropyl alcohol before applying the new power button.
 4. Completely remove the adhesive from the rear of the new power button.
 5. Route the power button flex cable through the slot on the front of the system and firmly press the power button in the recessed well of the front housing.

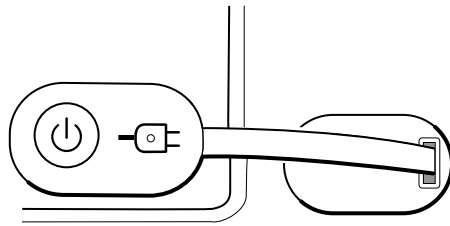

6. Connect the power button flex cable to J6 on the main board.

Replace the front housing

Complete the following preliminary steps:

- Power down the system and disconnect the AC power cord.
 - Remove the modules in the main housing.
 - Remove the system from the wall and remove the battery.
 - Remove the handle module assembly.
 - Open the chassis.
 - Remove the light bar.
 - Remove the power panel.
 - Remove the power wire harness and the main wire harness.
 - Remove the modules in the bottom housing.
 - Remove the module well.
1. Disconnect all USB connections from the main board.
 2. Remove the bundled USB cables from the housing by removing the two large Phillips screws.

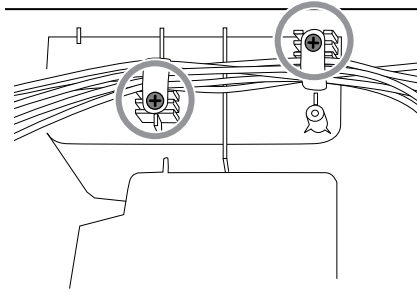

3. Disconnect the power button cable from the main board at J6.
4. Disconnect and remove the Ethernet cable.

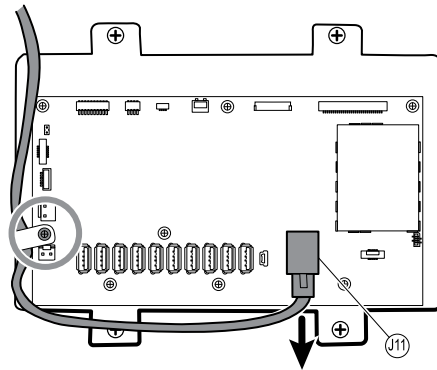

5. Remove the four large Phillips screws that mount the LCD to the housing.

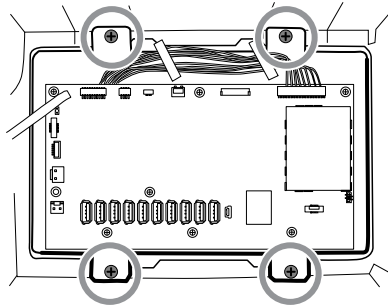

- Carefully lift the LCD and the attached main board from the housing.



CAUTION Support the LCD as you lift the assembly from the housing. The LCD is not secured to the assembly.

- Remove the two module tracks by removing the four Torx screws.

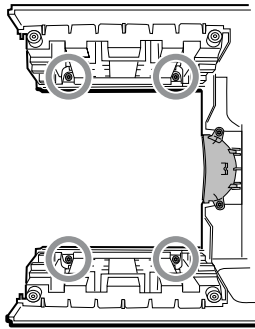

Section B

This section applies to devices that meet all of the following criteria:

- manufactured after 11/2017
- MCE hardware version P5 or later
- serial number after 100023374817.



NOTE See "Monitor serial number and model label" in the Appendix to learn how to determine the manufacture date from the serial number.

These devices comply with IEC 60601 3rd edition. Devices built after 12/2018 are 4th-edition compliant.



NOTE See Customer Service Bulletin 80022414 CSB – CVSM/CIWS IEC 60601 4th Edition for the exact manufacturing cutoff and start dates as well as the serial number for the first 4th-edition device.



NOTE If your device does not meet these criteria, see Section A for the correct disassembly and repair instructions.

If your device is IEC 3rd- or 4th-edition compliant, use only service kits with the "3rd Ed" or "4th Ed" suffix when replacing the following components:

- MCE (main board)
- LCD
- AC power supply
- AC power supply harness
- Ethernet cable
- main housing
- product labels
- SureTemp module
- Masimo SpO2 module
- NIBP module



NOTE For 4th-edition devices, use only 107124* when replacing Nellcor SpO2. Host software must be 2.40.01 or later.



NOTE Devices that are 4th-edition compliant cannot be downgraded below host software version 2.41.XX.

Power down the device

You can power down the device as follows: 1) on devices with 2.X software, briefly press the power button on the housing and then following the onscreen prompts, or 2) on all devices, use onscreen controls alone.

Option 1. After the device is powered up, briefly press of the power button to open an onscreen dialog with the following options:

- **Power down.** Device behavior varies based on the active profile, whether or not patient trend data is stored, and whether or not patient context is established. While servicing the device, you need not be concerned about these details. They only matter to clinicians who are monitoring patients and storing patient data.
- **Sleep.** The Sleep button clears the display and puts the device into Display power-saving mode.
- **Cancel.** The Cancel button dismisses the dialog.

Touch **Power down** and complete the power-down procedure.

Option 2. To use onscreen controls alone to power down the device, follow these steps:

1. Touch the **Settings** tab.
2. Touch the **Device** tab.
3. Touch **Power down**.



NOTE The next three sections address disassembly and repair steps you can complete without removing the device from the wall or removing the battery. All steps presented after “Remove the system from the wall and remove the battery” require powering down as well as removing the device from the wall and removing the battery.

Exploded view, front exterior

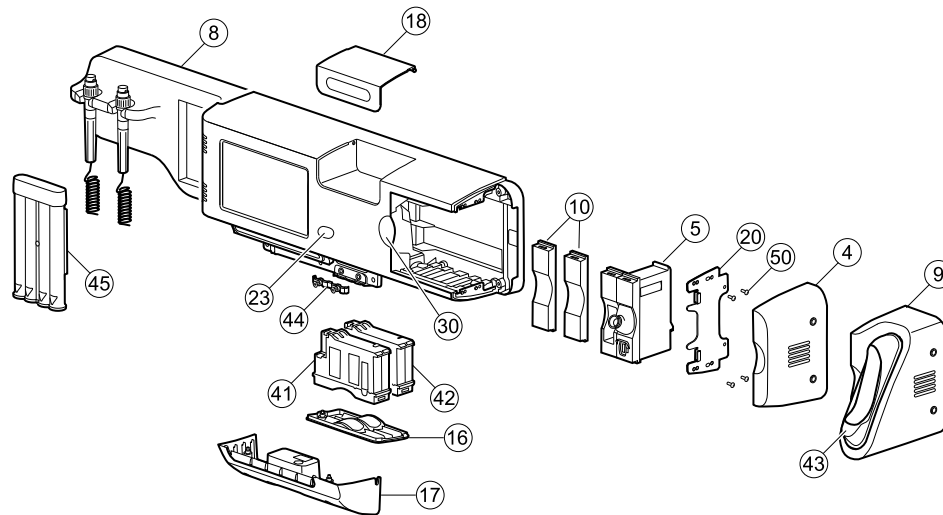

No.	Item	No.	Item
4	Side housing	23	Power button
5	SureTemp module	30	Blue insert
8	CIWS handle module assembly	41	NIBP module
9	Braun housing	42	SpO2 module
10	Platform module, blank	43	Braun dock
16	Module cover	44	Strain relief, comms, PW
17	Communications cover housing	45	Ear speculum dispenser, small
18	Cubby door	50	Screw, M3 x 0.5, Pan Phillips
20	Side mounting bracket/Module retaining plate		

Replace modules in the bottom housing

1. Power down the system and disconnect the AC power cord.
2. Disconnect the NIBP hose and the SpO2 cable if present.
3. Remove the communications cover housing.

Loosen the two captive screws using a #2 Phillips screwdriver to remove the communications cover.

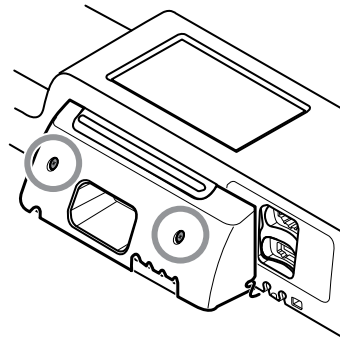

4. Remove the module cover.

Loosen the captive screw using a #2 Phillips screwdriver to remove the module cover.

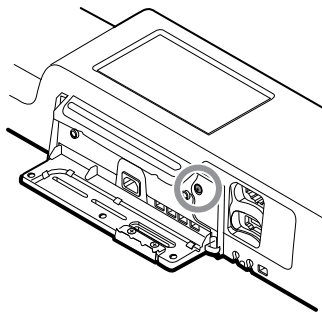

NOTE The modules fit tightly in the housing but can become loose over time. Support the modules to prevent them from falling out as you remove the module cover.

5. Remove the module you want to replace.

Slide the module out of the housing by inserting a finger in the slot at each end of the module and gently pull the module away from the housing until you completely remove it.

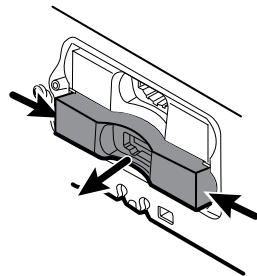

6. Disconnect the USB cable from the rear of the module.

Reassembly notes

- When aligning the module with the housing, the USB connection is on the left.
- The NIBP module must always be in the front-most slot.

Replace modules in the main housing



NOTE Check how the end cap or Braun thermometer housing are attached to the device. If bushings with captive screws attach the end cap or Braun thermometer housing to the side of the main housing as shown in step 1, proceed with the instructions as presented. If you don't see bushings with captive screws on the end cap or the Braun thermometer housing, then these parts are attached to the back of the chassis, not the right side. To remove these parts and access any front-facing modules, first remove the device from the wall. (See "Remove the system from the wall and remove the battery.")

1. Power down the system and disconnect the AC power cord.
2. Loosen the two captive #2 Phillips screws that hold the end cap or the Braun thermometer housing in place.

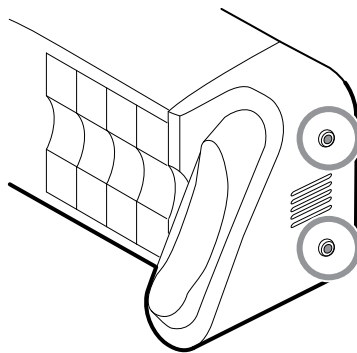

3. Remove the end cap or thermometer housing by sliding the piece away from the wall and then to the right.

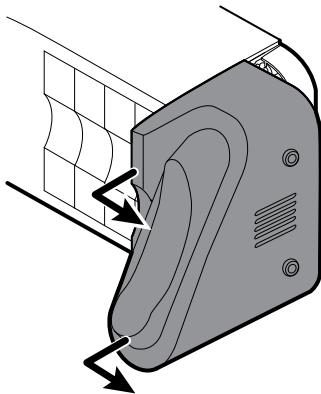

4. Disconnect the USB cable from the Braun dock, which you can access from the rear of the Braun housing.
5. Locate and remove the module retaining plate by removing the four #2 Phillips screws.

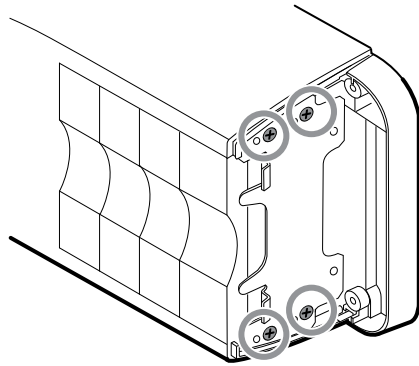

6. If SureTemp is installed, remove the module and the probe cover storage together, sliding them out the open end, and disconnect the USB cable.
7. Slide any blank face plates or modules to be removed toward the open end.



NOTE When removing any connected modules, disconnect the USB cables before you remove the module.



NOTE If you are replacing a Braun 4000 thermometer with a Braun 6000 thermometer, you must also replace the dock.

Remove the Braun dock from the housing

1. Hold the Braun housing with your right hand and the dock with your left hand as shown. With your right-hand fingers inside the housing, gently press the housing toward you and away from the dock. At the same time, gently push the dock away from you until the dock unsnaps from the housing.

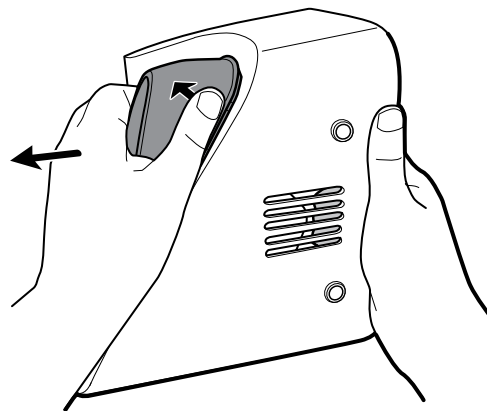

2. When the dock is completely loose, remove it from the housing.

Reassembly notes

- When aligning the module with the housing, the USB connection is on the bottom.
- The temperature module must always take up the last two spots closest to the end.
- The blank cover's beveled edge must be on the right when facing the device for proper alignment.

- When replacing the Braun dock, insert the bottom of the dock into the housing, align the molded ridges in the top of the dock with the slots in the top of the housing, and snap the dock into the housing.

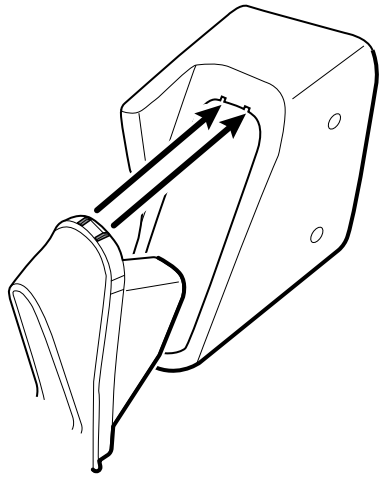

Remove the system from the wall and remove the battery

1. Power down the system and disconnect the AC power cord.
2. Disconnect any detachable sensors and cables:
 - Blood pressure cuffs and hoses
 - Temperature probes and cables
 - Braun thermometer
 - SpO2 sensors and cables
 - 3.5V instrument heads
3. Remove any items in the storage area and any other loose items before attempting to remove the system from the wall.
4. Close the storage area door and seal it with a piece of adhesive tape to prevent the door from opening.
5. Remove the speculum holder by lifting it up and away from the handle housing.

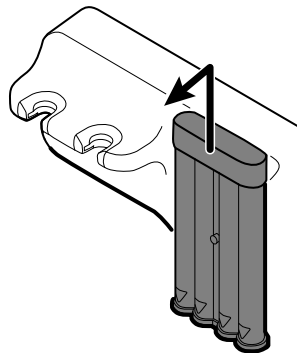

6. Remove the AC power cord.
7. Remove the communications connection cover.

Loosen the two captive screws, using a #2 Phillips screwdriver, until the cover is free from the housing.

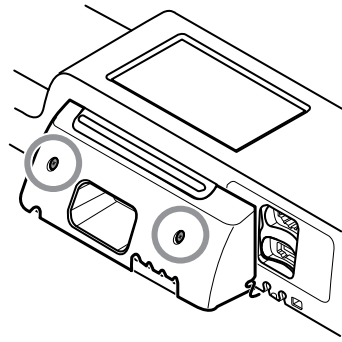

8. Remove the wall anchor screws using a #2 Phillips screwdriver.

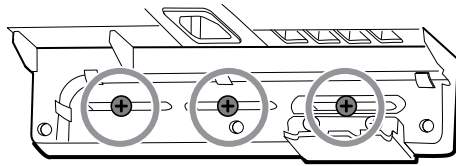

9. Hold the bottom and top of the system and push it up to remove the system from the wall mounting bracket.
10. Place the wall system on a table or flat work surface so that the back of the wall system faces up. Ensure that the display is protected from pressure or getting scratched.

11. Locate the battery, indicated by 
12. Remove the battery.

Remove the light-bar board

Complete the following preliminary steps:

- Power down the system and disconnect the AC power cord.
- Remove the system from the wall and remove the battery.

1. Remove the two torx screws from the light-bar cover.

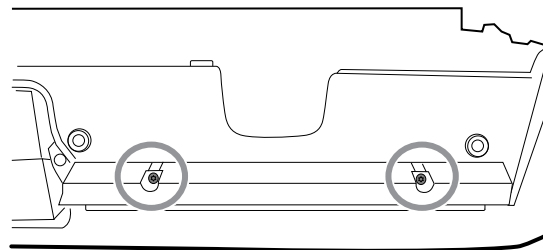

2. Remove the light bar and cover.

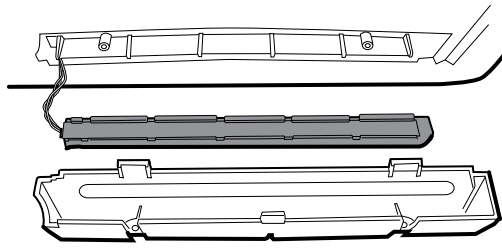

3. Remove the light bar from the light-bar cover.
4. Disconnect the light-bar harness from the light-bar board.

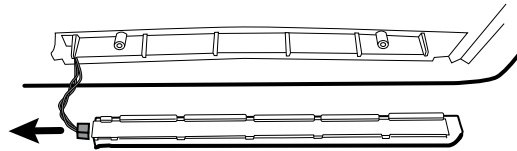

5. Remove the light-bar board from the light bar by sliding the board out from the connector end.

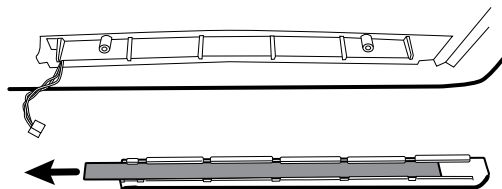

Reassembly notes

- Insert the light-bar board by placing the end without the connector into the open end of the light bar.
- Slide the light-bar board into the light bar until the connector end is flush with the end of the light bar.
- Feed the light-bar harness wires through the slot so they do not get pinched during reassembly.

Exploded view, rear interior

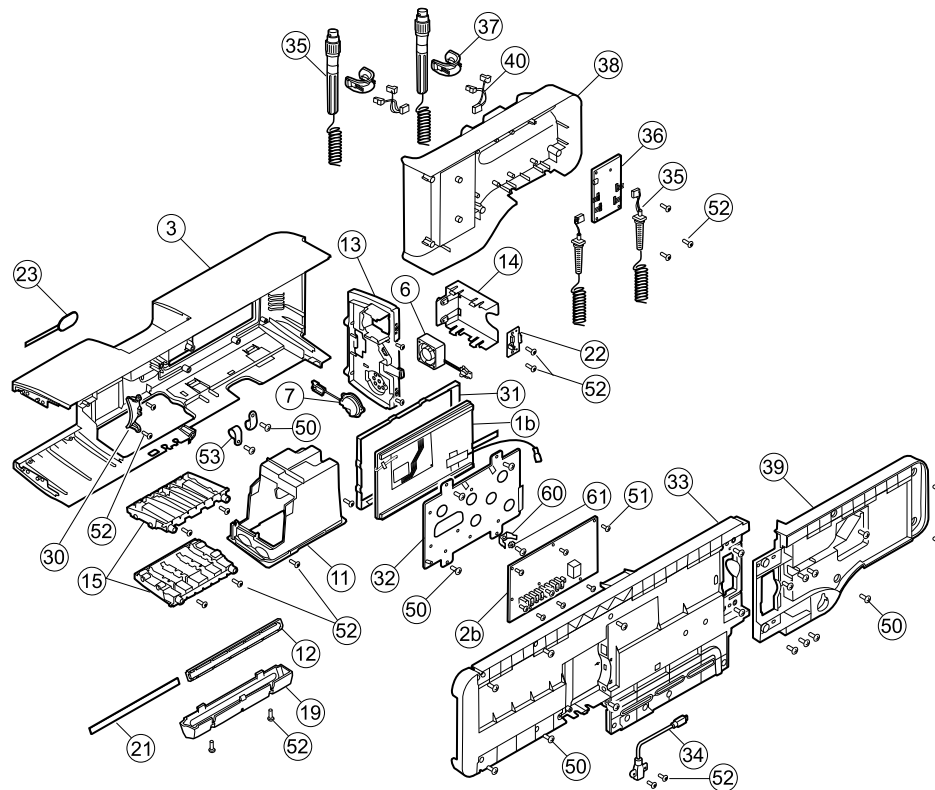

No.	Item	No.	Item
1b	LCD with touchscreen	31	LCD bezel
2b	Main board	32	LCD frame
3	Main housing	33	Chassis
6	Platform fan assembly	34	Cable, USB client
7	Platform speaker assembly	35	Handle assembly
11	Module well assembly	36	PCBA: Platform 767 controller, pattern E
12	Light bar	37	Handle, cradle, and opticals assembly, cool blue
13	Power panel	38	Housing, front handle
14	Battery housing	39	Housing, rear handle
15	Module track	40	IR connector and wire assembly
19	Light-bar cover	50	Screw, M4 x 10, Pan head with nyloc (Large Phillips screw)

No.	Item	No.	Item
21	Light-bar board	51	Screw, M3x0.5x8, Pan Phillips (Small Phillips screw)
22	Battery connector	52	Screw, Plastite #4-20 x .500 Pan head (Torx screw)
23	Power button and flex cable	53	CCH44-S10 P-clamp, 0.437
30	Blue insert		

Remove the handle module assembly

Complete the following preliminary steps:

- Power down the system and disconnect the AC power cord.
 - Remove the system from the wall and remove the battery.
1. Cut and remove the cable tie that holds the USB ferrite in place.

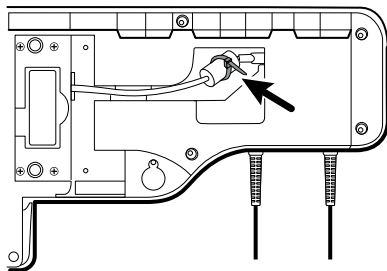

2. Disconnect the USB cable.
3. Remove the ferrite from the USB cable by pulling apart the two clips and lifting up.

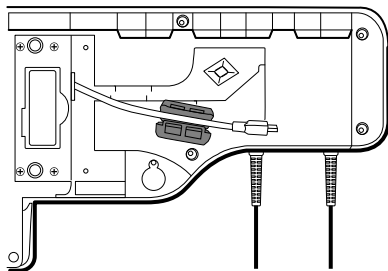

4. Remove the four large Phillips screws while supporting the end of the handle module assembly.

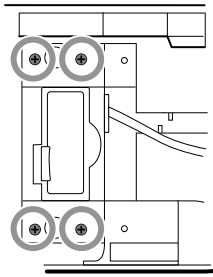

5. Lift the handle module assembly up and away from the main assembly while guiding the USB cable through the slotted opening.

Remove the handles

Complete the following preliminary steps:

- Power down the system and disconnect the AC power cord.
 - Remove the system from the wall and remove the battery.
 - Remove the handle module assembly.
1. Remove the six large Phillips screws on the back of the assembly, then lift and remove the rear handle housing.

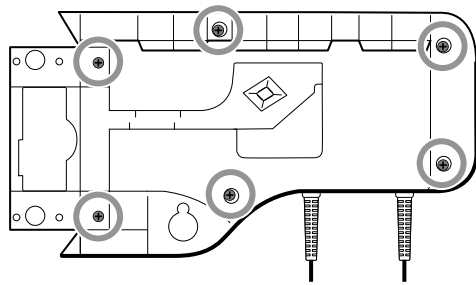

2. Disconnect the handle connector wires from the 767 Controller PCBA.

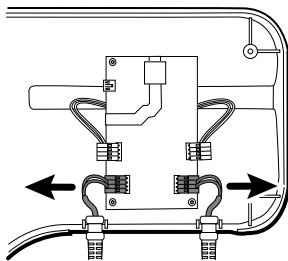

3. Lift and remove the handle cables from the front handle housing.

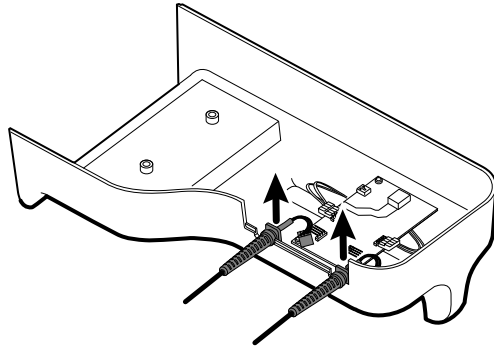

Reassembly note

When reconnecting the handle connection wires to the handle PCBA, the connecting wires must be facing up and away from the PCBA.

Remove the 767 controller PCBA

Complete the following preliminary steps:

- Power down the system and disconnect the AC power cord.
 - Remove the system from the wall and remove the battery.
 - Remove the handle module assembly.
 - Remove the handles.
1. Disconnect the two IR wire connectors from the handle PCBA.

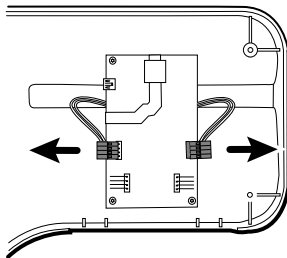

2. Remove the three Torx screws.

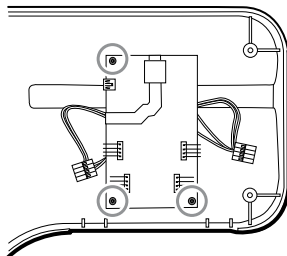

3. Lift and remove the PCBA.

Reassembly note

When reconnecting the IR wire connectors to the handle PCBA, the connecting wires must be facing down and toward the cradle assemblies.

Remove the handle cradle and optical assemblies

Complete the following preliminary steps:

- Power down the system and disconnect the AC power cord.
 - Remove the system from the wall and remove the battery.
 - Remove the handle module assembly.
 - Remove the handles.
 - Remove the 767 Controller PCBA.
1. On the rear of the assembly, disconnect both IR wires from the optical sensors.

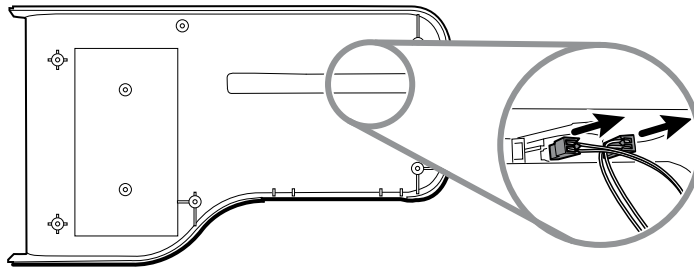

2. Push in the snap tabs and remove the cradle assembly by pushing outward.

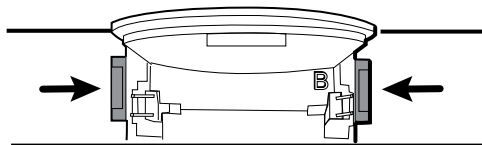

Reassembly notes

- For ease of assembly, connect the IR wire assemblies to the optical sensors before attaching the handle cradle to the handle assembly housing.
- Attach the connector with the black and white wires to the optical detector (indicated by the letter "B" molded into the cradle plastic). Attach the connector with the red and white wires to the optical emitter. The wires should face inward once the handle cradle is assembled.

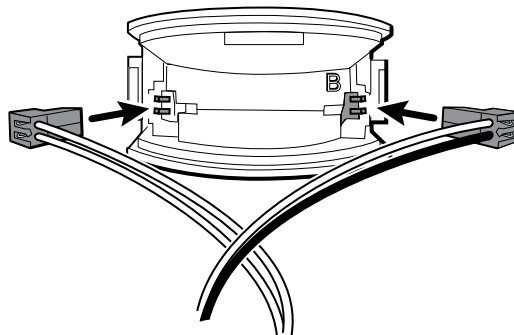

- Snap the handle cradle assembly into the front housing. Make sure that the cradle assembly tab and the beveled edge are at the top of the housing.

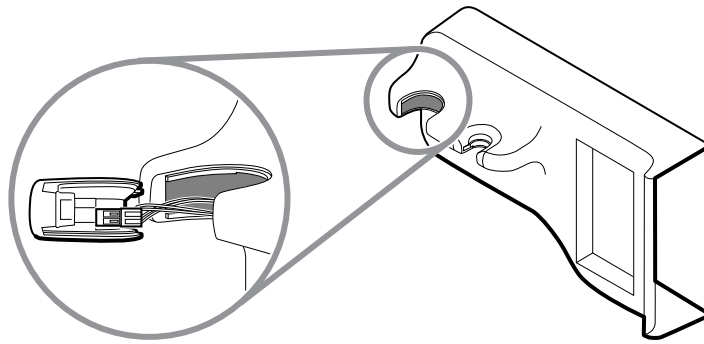

Open the chassis

Complete the following preliminary steps:

- Power down the system and disconnect the AC power cord.
 - Remove the system from the wall and remove the battery.
 - Remove the handle module assembly.
1. Remove the Braun module if present as described in "Remove modules from the main housing."
 2. Remove the 8 screws as shown.

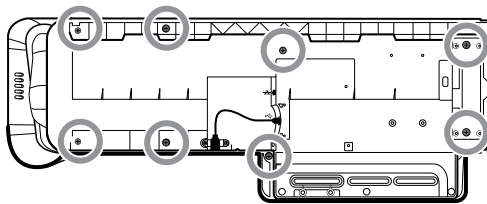

3. Remove the two Torx screws securing the client USB connector to the housing, and then disconnect and remove the cable.

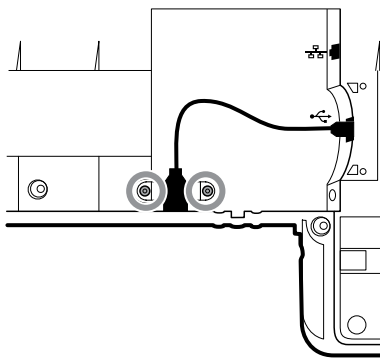

CAUTION Multiple wire connections are still connected between the front housing and the chassis. These must be disconnected before it is safe to completely separate the two pieces.

4. Carefully lift the top of the chassis away from the front housing while leaving slack in all cable connections.

From the communications board, disconnect the following in the order presented:

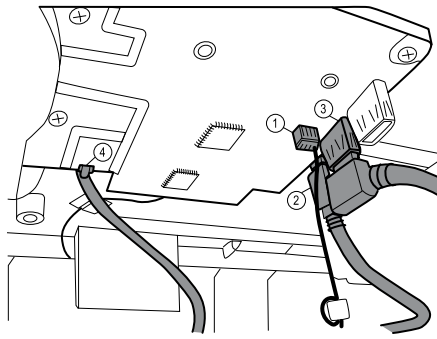

Number	Item
1	Small 4-pin connector
2	Mini USB cable
3	USB cable
4	Ethernet cable

5. Disconnect the power supply cable from the power supply.

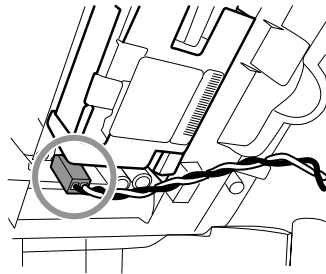

6. Separate the chassis from the front housing enough to make the AC power harness ground connection reach the dual spade connector.
7. Disconnect the AC power harness ground wire from the dual spade connector on the LCD frame.

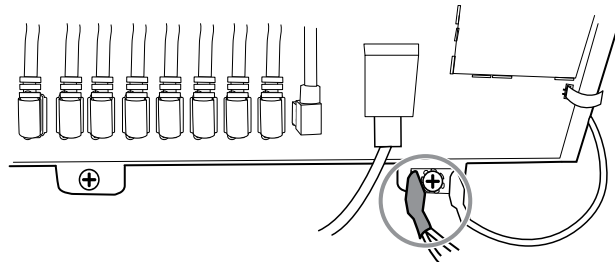

Reassembly notes

- Align the chassis with the front housing.
- Connect the ground wire to the dual spade connector on the LCD frame.

- Connect the large USB connector on the communications board.
- Connect the mini-B USB connector on the communications board.
- Connect the small 4-pin connector on the communications board.
- Connect the power harness to the power supply.
- Connect the Ethernet cable on the communications board.
- Lower the chassis onto the front housing while pushing the Ethernet cable between the molded standoff and the housing to clear the antenna board.
- Guide the end of the client USB cable through the opening in the front housing.
- Align the tab between the cable guides (next to the USB client) with the slot on the front housing and snap the chassis and front housing together.
- Inspect all the seams between the front housing and the chassis for proper fit.
- Install the screws to secure the front housing to the chassis.

Exploded view, chassis

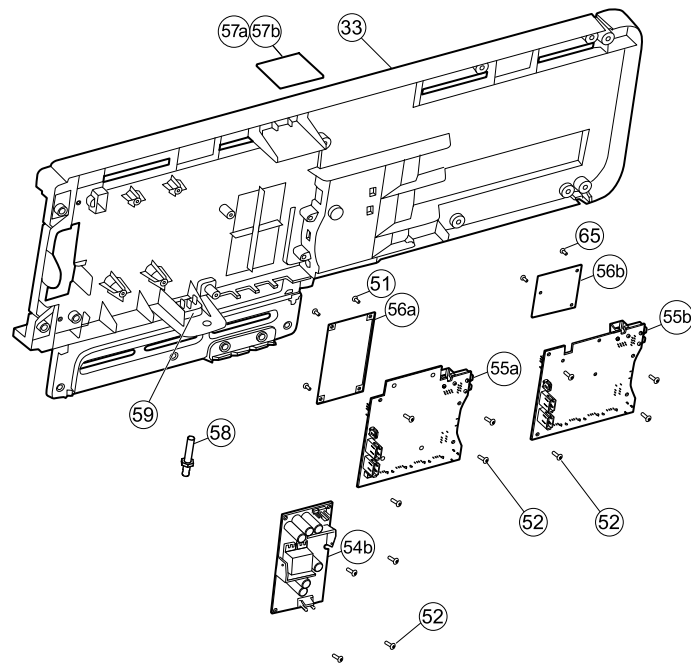

No.	Item	No.	Item
33	Chassis	56b	Radio board (Newmar)
51	Screw, M3x0.5x8, Pan Phillips (Small Phillips screw)	57a	Antenna board (Lamarr)
52	Screw, Plastite #4-20 x .500 Pan head (Torx screw)	57b	Antenna board (Newmar)
54b	Power supply, 60W	58	Ground lug
55a	Communications board (Lamarr)	59	IEC connector
55b	Communications board (Newmar)	65	Screw, M2 x 6, Pan head
56a	Radio board (Lamarr)		

Remove the power supply

Complete the following preliminary steps:

- Power down the system and disconnect the AC power cord.
 - Remove the system from the wall and remove the battery.
 - Remove the handle module assembly.
 - Open the chassis.
1. Disconnect the green ground cable and the AC power harness from the power supply.

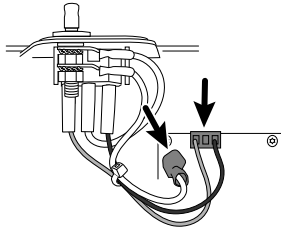

2. Remove the four torx screws.

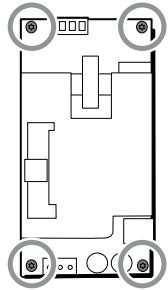

3. Remove the power supply.

Reassembly note

When reinstalling the power supply, orient the board so that the end of the board with the AC-to-power-supply (J1) connection is closest to the IEC connector.

Remove the ground lug, AC power harness assembly, and IEC connector



NOTE Do not disconnect the AC power harness from the IEC connector unless you are replacing it. Once you disconnect the AC power harness, you cannot reuse it.

Complete the following preliminary steps:

- Power down the system and disconnect the AC power cord.
 - Remove the system from the wall and remove the battery.
 - Remove the handle module assembly.
 - Open the chassis.
1. Disconnect the AC power harness and ground from the power supply.

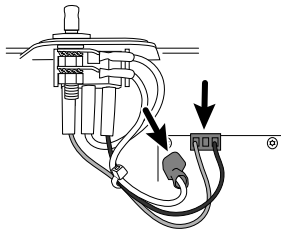

2. To remove the ground lug:

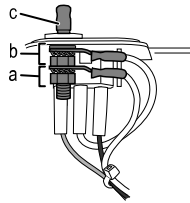

- a. Remove the 10mm hex nut and slide out the star lock washer and the ground wire (power supply) ring terminal.
 - b. Remove the next 10 mm hex nut and slide out the star lock washer, the ground wire (mains) ring terminal, and the flat washer.
 - c. Remove the bare ground lug by pulling it out from the outside of the chassis.
3. To remove the IEC connector:
- a. Disconnect the three power wires: blue neutral (N), green ground (G), and brown line (L).

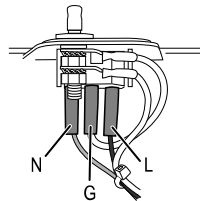

NOTE You must now replace the AC power harness. It cannot be reused.

- b. Push in on the three plastic release tabs to release the IEC connector.

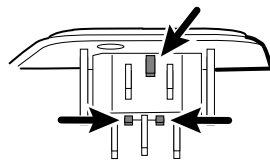

Remove the communications board

Complete the following preliminary steps:

- Power down the system and disconnect the AC power cord.
- Remove the system from the wall and remove the battery.
- Remove the handle module assembly.
- Open the chassis.

1. Disconnect the mini-USB connection on the outside of the chassis.

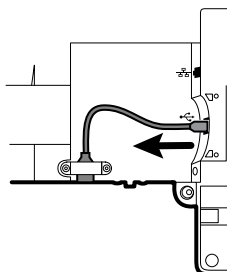

2. Turn over the chassis to access the communications board.

3. Remove the four Torx screws.

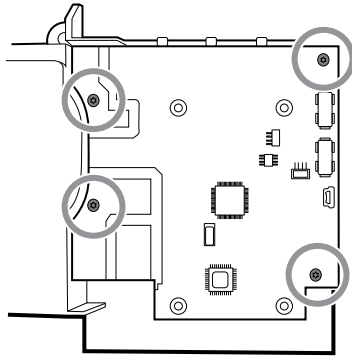

4. Lift the communications board from the chassis.
5. For systems with the radio option, remove the tape securing the antenna cable to the chassis, and rotate the communications board counter-clockwise to clear the chassis. Make sure not to pull on the antenna cable. Turn the board over and place it inside the chassis.

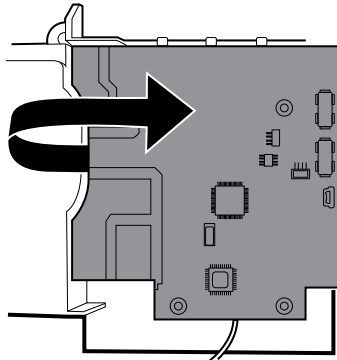

6. If replacing the communications board, remove the radio board as described in "Remove the radio board and antenna."

Remove the radio board and antenna



NOTE Do not remove the antenna board from the chassis unless you are replacing the radio and/or the antenna and/or the chassis.

Complete the following preliminary steps:

- Power down the system and disconnect the AC power cord.
- Remove the system from the wall and remove the battery.
- Remove the handle module assembly.
- Open the chassis.
- Remove the power supply.
- Remove the ground lug, AC power harness, and IEC connector.
- Remove the communications board.

1. Remove the radio board:
 - a. Turn the communications board over to access the radio board, taking care to avoid straining the antenna cable.
 - b. If the original Lamarr radio (a/b/g band) is installed, remove the four small Phillips (machine) screws securing the radio board to the communications board, as shown on the left. If the Newmar radio (a/b/g/n band) is installed, remove the three small Phillips

(machine) screws securing the radio board to the communications board, as shown on the right.

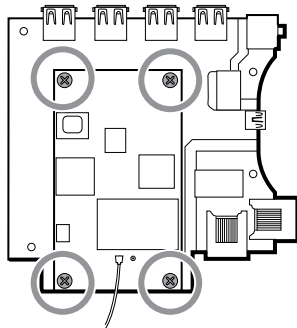
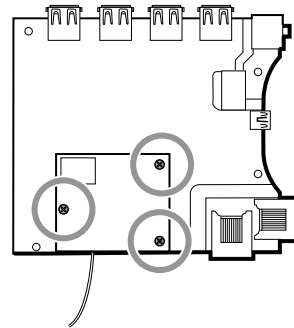
Lamarr**Newmar**

- c. Hold the communications board with one hand while grasping the radio board at the opposite end from the antenna connection and pull the radio board away from the communications board.
2. Remove the antenna and antenna cable.

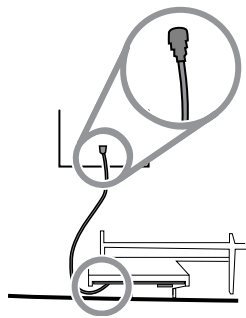

- a. Carefully disconnect the antenna cable by lifting up on the wire neck just before the connection point.
- b. Use a soft tool such as a spudger to separate the adhesive from the inside of the chassis of the antenna plate.

Reassembly notes

If the antenna is removed:

- Clean the chassis and mounting surface with 70 percent isopropyl alcohol.
- Peel the backing off the double-stick tape and affix it to the chassis antenna plate.
- Mount the antenna to the antenna plate. Make sure the PG terminal on the antenna board is facing outwards.

Antenna cable connection:

- The following illustration shows both Lamarr and Newmar radio and antenna boards. The instructions for both sets of boards is the same. Attach the antenna cable to terminal G on the radio board. Attach the other end of the cable to the antenna on terminal PG.

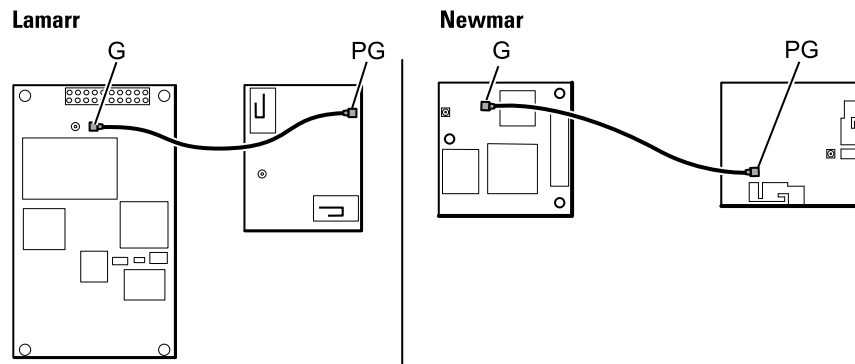

- Once the antenna, radio, and communications board are mounted and secure, secure the antenna cable to the housing with Pro Gaff tape.

Replace the chassis

Complete the following preliminary steps:

- Power down the system and disconnect the AC power cord.
- Remove the system from the wall and remove the battery.
- Remove the handle module assembly.
- Open the chassis.
- Remove the power supply.
- Remove the communications board.
- For systems with the radio option, remove the radio board and antenna.

Remove the USB client cable from the outer side of the chassis by removing the two Torx screws.

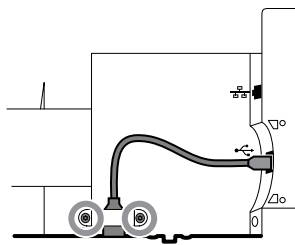

Disconnect or remove the light bar

Complete the following preliminary steps:

- Power down the system and disconnect the AC power cord.
 - Remove the system from the wall and remove the battery.
 - Remove the handle module assembly.
 - Open the chassis.
1. Remove the two Torx screws from the light-bar cover.

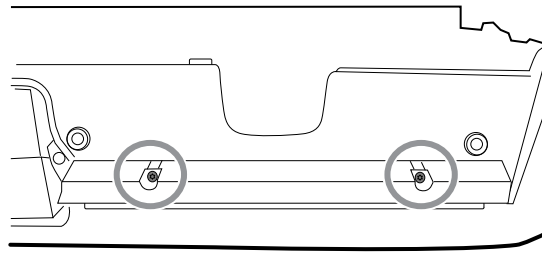

2. Remove the light bar and cover.

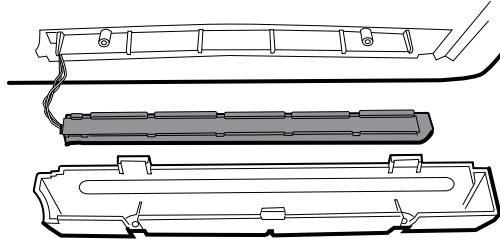

3. Remove the light bar from the light-bar cover.
4. Disconnect the light-bar harness from the light-bar board.

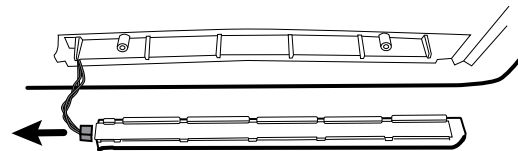

5. If replacing the light-bar board, remove the light-bar board from the light bar by sliding the board out from the connector end.

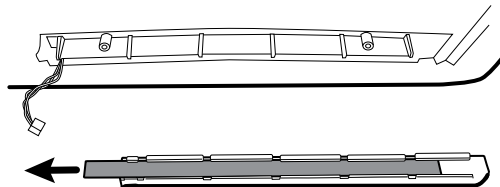

Reassembly notes

- Insert the light-bar board by placing the end without the connector into the open end of the light bar.
- Slide the light-bar board into the light bar until the connector end is flush with the end of the light bar.
- Feed the light-bar harness wires through the slot so they do not get pinched during reassembly.

Disconnect or remove the fan

Complete the following preliminary steps:

- Power down the system and disconnect the AC power cord.
- Remove the system from the wall and remove the battery.
- Remove the handle module assembly.

- Open the chassis.
1. Disconnect the power cable from the fan harness connector.

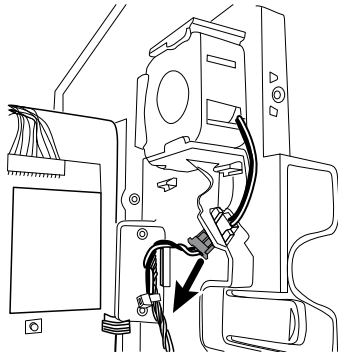

2. Press the flanges on the sides of the fan harness connector and separate the fan connector from the power panel.

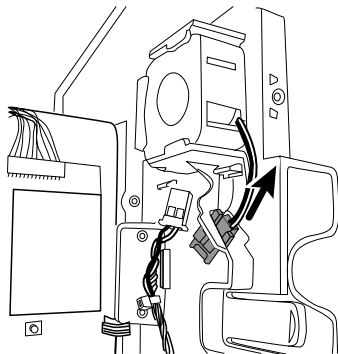

3. If you are removing the fan, slide the fan up and remove.

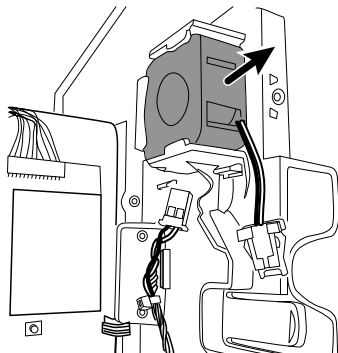

Reassembly note

Install the fan with the label facing the power panel.

Disconnect or remove the power panel

Complete the following preliminary steps:

- Power down the system and disconnect the AC power cord.
- Remove the system from the wall and remove the battery.
- Remove the handle module assembly.
- Open the chassis.

- Remove the fan.
1. If you haven't done so already, disconnect the power cable from the fan harness connector.

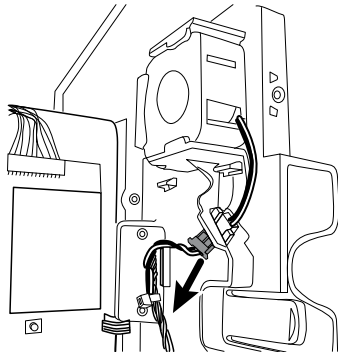

2. Disconnect the two harness connectors from the battery board.

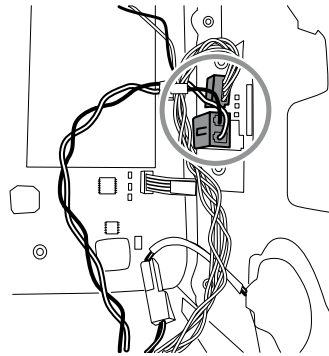

3. Disconnect the speaker connector wire.

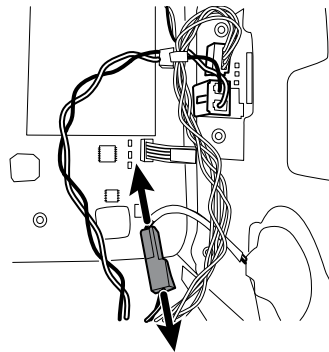

4. Remove the two Torx screws that attach the power panel to the front housing and slide the power panel out of the housing.

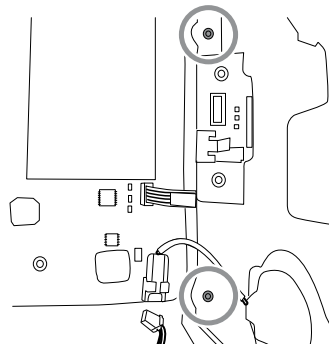

5. Pull the module handle assembly USB cable through the access hole in the power panel.

Reassembly notes

- Pull the module handle assembly USB cable through the access hole in power panel before securing the power panel to the housing.
- When installing the power panel in the housing, do not obstruct the channel or allow the battery board or battery housing to push the LCD flex sideways.
- Reconnect the speaker, battery board, and fan harnesses.

Remove the speaker

Complete the following preliminary steps:

- Power down the system and disconnect the AC power cord.
 - Remove the system from the wall and remove the battery.
 - Remove the handle module assembly.
 - Open the chassis.
 - Remove the power panel.
1. Carefully pry the speaker and adhesive away from the power panel.
 2. Remove any remaining gasket material and clean the surface with 70 percent isopropyl alcohol.
 3. Remove the paper on the speaker to expose the adhesive on the gasket.
 4. Apply pressure to the outer radius of the speaker assembly to assure good adhesion with the power panel.

Replace the battery board

Complete the following preliminary steps:

- Power down the system and disconnect the AC power cord.
 - Remove the system from the wall and remove the battery.
 - Remove the handle module assembly.
 - Open the chassis.
 - Remove the power panel.
1. Remove the battery compartment from the power panel by pushing in on the four plastic tabs.

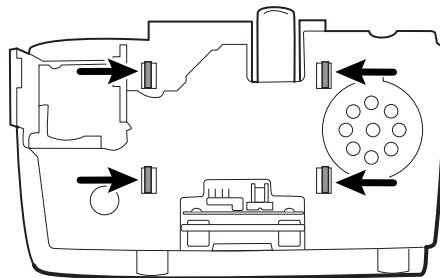

2. Remove the two Torx screws from the battery compartment and remove the battery board.

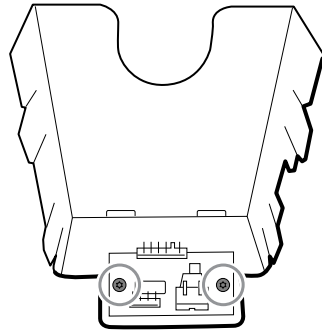

- Secure the new battery board to the battery compartment with two Torx screws.

Disconnect or remove the power wire harness and main wire harness



NOTE If removing the main board or LCD, it is not necessary to cut wire ties attaching the harness to the housing unless you are replacing the harness or the housing.



NOTE When replacing the main harness, you must disconnect the light-bar board from the main harness.

Complete the following preliminary steps:

- Power down the system and disconnect the AC power cord.
 - Remove the system from the wall and remove the battery.
 - Remove the handle module assembly.
 - Open the chassis.
- Disconnect the USB connections from the main board in positions 1 through 9. Remove the USB cables from the cable separator to clear the work area.

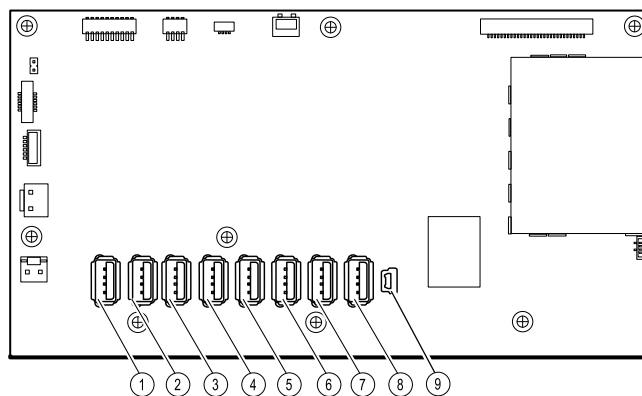

- Disconnect the connectors as follows:
 - To disconnect the power harness, disconnect the connectors at J29 and J30.
 - To disconnect the main harness, disconnect the connectors at J34, J12, J49, J46, and J45.

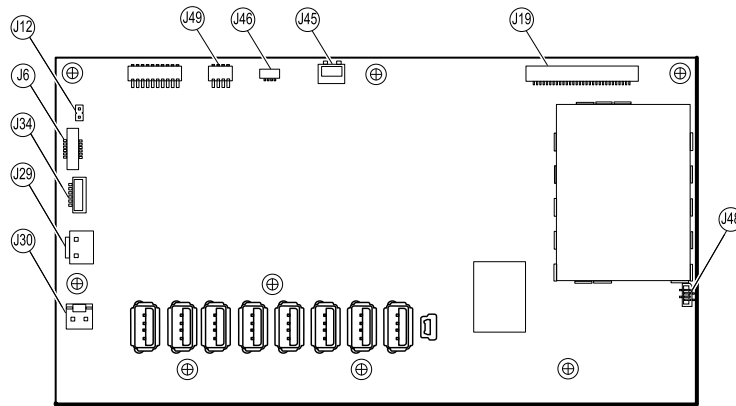

3. If you are replacing the power harness, disconnect the power harness from the power panel and carefully cut the two wire ties and remove the harness.
4. If you are replacing the main harness, disconnect the main harness from the power panel and carefully cut the two wire ties to remove the harness.

Reassembly notes

When replacing the main harness:

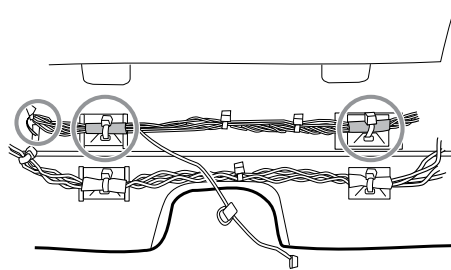

- Align the shrink-wrapped sections and their wire tie anchors with the light-bar wires on the left.
- Feed the light-bar wires through the rectangular opening in the bottom of the housing to the right of the module well.
- Attach the harness to the main housing using the wire tie anchors closest to the display or front of the housing.

When replacing the power harness:

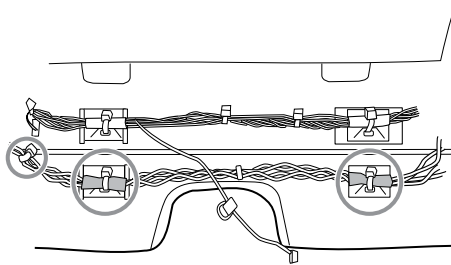

- Align the shrink-wrapped sections with the wire tie anchors.
- Align the end with the wire tie closest to the end on the left to connect with the main board.
- Attach to the main housing using the wire tie anchors closest to the back of the housing.

- Route the connections from the main harness to the main board (communications power, light bar, fan) **over** the last USB cable, **under** the remaining USB cables, and **through** the harness standoff. Twist to lock the harness in the standoff.

Remove the main board

Complete the following preliminary steps:

- Power down the system and disconnect the AC power cord.
- Remove the system from the wall and remove the battery.
- Remove the handle module assembly.
- Open the chassis.
- Disconnect the power wire harness and the main harness.

- Disconnect the following on the main board:
 - The power button flex cable at J6.
 - The LCD harness at J19.
 - The LCD flex cable at J48.

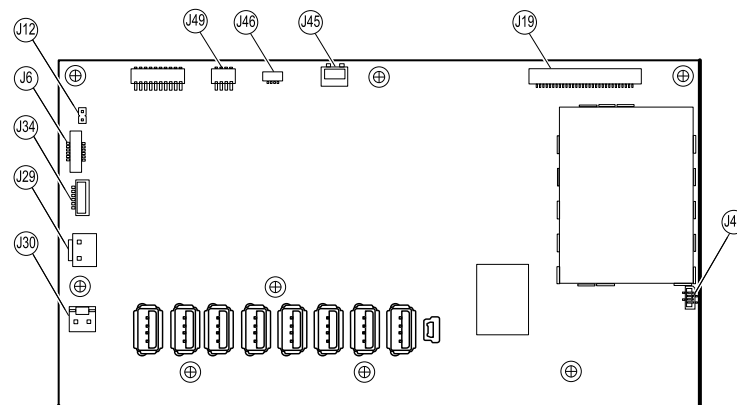

- Remove the Ethernet cable:
 - Disconnect the Ethernet cable from the Ethernet cable connector at J11 on the main board.
 - Remove the screw that secures the Ethernet cable P-clamp to the main board.
 - Remove the Ethernet cable.

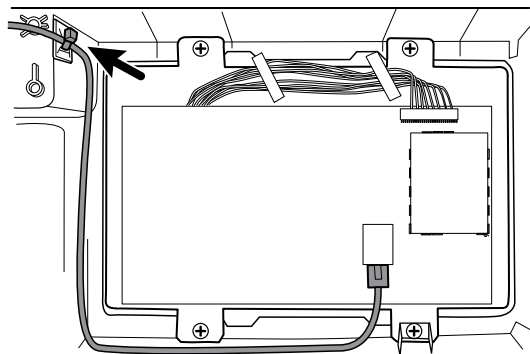

- Remove the seven small Phillips screws that secure the main board to the LCD frame.

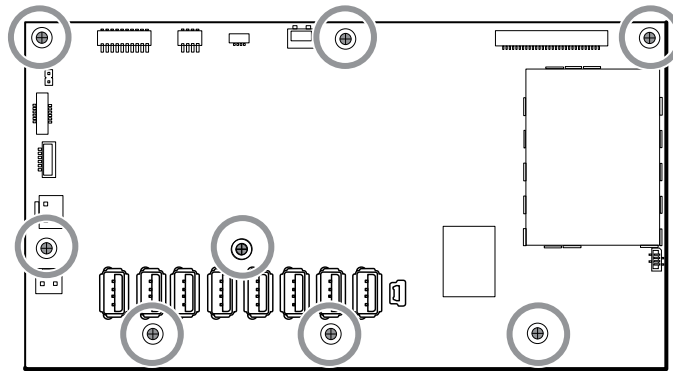

4. Remove the main board.

Reassembly notes

- Ensure that the LCD flex cable is not under the main board.



CAUTION The solder joint of the LCD connector (J48) is fragile. When inserting or removing the flex cable, do not stress the solder joint.

- Connect the Ethernet cable to the main board.
- Route the Ethernet cable **under** the power harness and **over** the main harness.
- The USB cable runs over the Ethernet cable as shown.

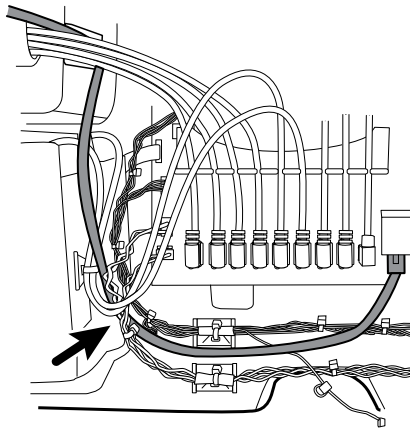

- Use a wire tie to secure the Ethernet cable to the anchor mounted on the housing just below the screw, securing the USB cables as shown.

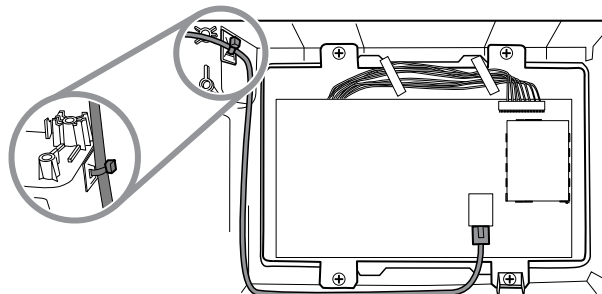

When replacing the main board



NOTE Use only 3rd edition-compliant main boards.

- When ordering the replacement main board, order the standard license for the model being serviced. You will receive an authorization code to enter in the service tool to reactivate the licenses included with the original configuration.
- Before installing the main board, record the serial number of the main board.
- After reassembling the system, use the service tool to provision the system as follows:
 - Enter the device's serial number. This can be found on the bottom of the device.
 - Enter the main board (host controller) serial number.
 - Select the Connex Integrated Wall System from the device model dropdown menu.
 - Restore any previously licensed features by entering the authorization code in the service tool. Use the authorization codes that accompanied the replacement board, along with any additional license authorization codes previously installed. Record the device serial number on the license authorization code cards received with the replacement board and retain for future use. If the license is lost, you can reuse the authorization code on the same device.
 - Update the host controller software to the current version or version in use at your facility. If the required version of the host software is not available after connecting the device to the service tool, contact Welch Allyn Technical Support.

Remove the LCD

Complete the following preliminary steps:

- Power down the system and disconnect the AC power cord.
 - Remove the system from the wall and remove the battery.
 - Remove the handle module assembly.
 - Open the chassis.
 - Disconnect the power wire harness and the main harness.
 - Remove the main board.
1. Remove the tape and disconnect the LCD harness from the LCD. For easier access to the connector, you can slide the ferrite bead closest to the connector up the harness.

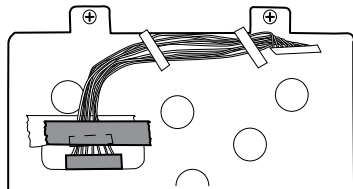

2. Disconnect the LCD ground wire from the dual spade connector.

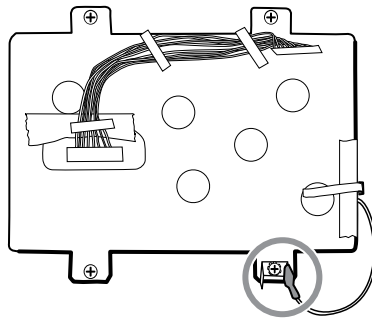

3. Remove the four large Phillips (shoulder) screws that secure the LCD frame along with the dual spade connector.
4. Remove the LCD frame.



NOTE Be sure to support the LCD if you are removing it with the frame. The foam strips on the LCD might cause the LCD to stick to the frame.

5. Remove the LCD.

Reassembly notes

- Insert the display into the bezel with the LCD flex cable on the lower right as shown. Verify that the LCD flex cable feeds through the bezel's clearance feature.

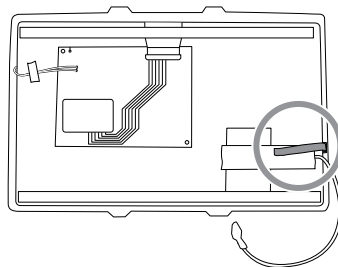

- Center the LCD and bezel in the main housing's molded channel with the bottom near the screw bosses.

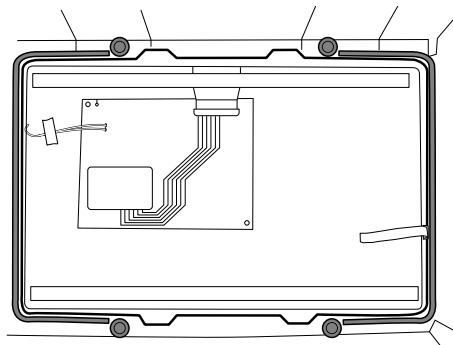

- Place the LCD frame over the LCD. Verify that the LCD frame does not cover the LCD flex cable.

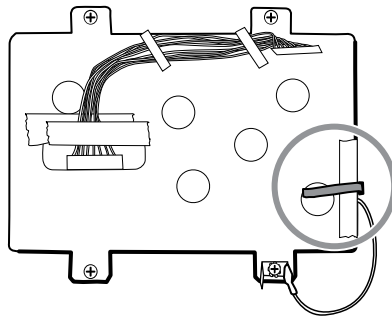

- Install the dual spade connector and secure it to the frame with the large Phillips screw closest to the LCD ground wire (lower right).
- Replace the Pro Gaff tape in the frame opening under the display harness as shown.
- After connecting the display harness to the LCD, secure the harness to the LCD frame with Pro Gaff tape as shown.

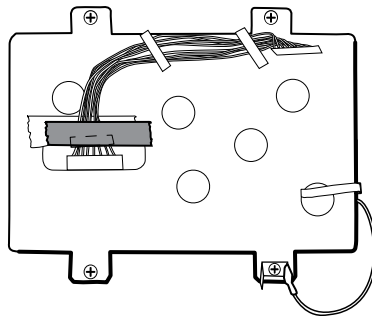

When replacing the LCD frame

- Install a 3-inch strip of Pro Gaff tape over the top part of the LCD harness cutout to protect the LCD harness from abrasion.

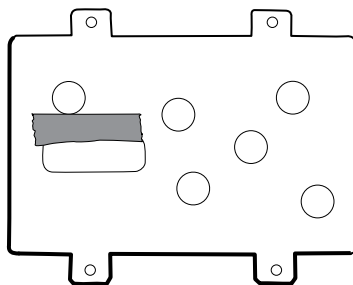

- Install the LCD harness. Use isopropyl alcohol to clean the area in the scribed boxes where you will mount the harness's ferrite beads. Expose the sticky backing on the ferrite beads and mount them in the scribed rectangles.



NOTE If you don't place the ferrites correctly in marked areas, they will obstruct the placement of other components like the MCE board.

- Replace the Pro Gaff tape in the frame opening under the display harness.
- After connecting the display harness to the LCD, secure it to the LCD frame with Pro Gaff tape as shown.

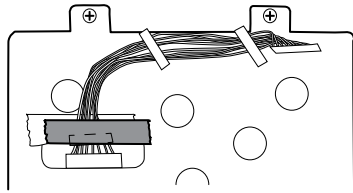

- After reconnecting the main harness, mount the harness standoff to the frame (see main harness reassembly notes).

When replacing the LCD

- Peel the protective sheet from the LCD.
- Verify that the foam strips are installed on the back of the LCD near the top and bottom edges.

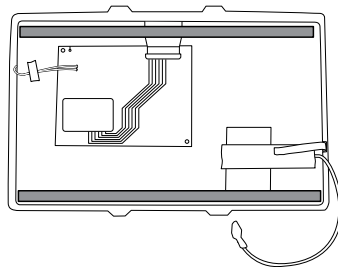

- Verify that the LCD flex cable feeds through the bezel's clearance feature.
- Insert the LCD into the bezel in the front housing with the LCD flex cable on the lower right as shown.

Remove modules in the bottom housing



NOTE These instructions are similar to "Replace modules in the bottom housing" presented earlier, but this topic assumes that you are not simply replacing the modules. Instead, you have taken the wall system off the wall and are removing modules to replace the power button or the front housing. If you have already removed these modules, proceed to "Remove the module well." Otherwise, choose one of the two following options:

Option 1. Complete the following preliminary steps if your goal is to replace the front housing:

- Power down the system and disconnect the AC power cord.
- Remove the system from the wall and remove the battery.
- Remove the handle module assembly.
- Open the chassis.
- Remove the light bar.
- Remove the power panel.
- Remove the power wire harness and the main wire harness.

Option 2. Complete the following preliminary steps if your goal is to replace the power button:

- Power down the system and disconnect the AC power cord.
- Remove the system from the wall and remove the battery.
- Remove the handle module assembly.

- Open the chassis.
 1. Power down the system and disconnect the AC power cord.
 2. Disconnect the NIBP hose and the SpO2 cable if present.
 3. Remove the communications cover housing.

Loosen the two captive screws using a #2 Phillips screwdriver to remove the communications cover.

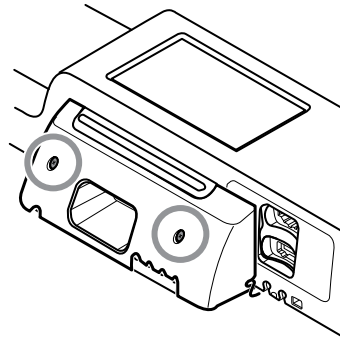

4. Remove the module cover.

Loosen the captive screw using a #2 Phillips screwdriver to remove the module cover.

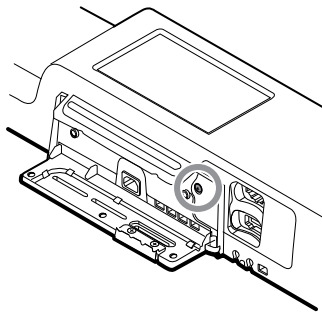

NOTE The modules fit tightly in the housing but can become loose over time. Support the modules as you remove the module cover.

5. Remove the modules.

Slide each module out of the housing by inserting a finger in the slot at each end of the module and gently pull the module away from the housing until you completely remove it.

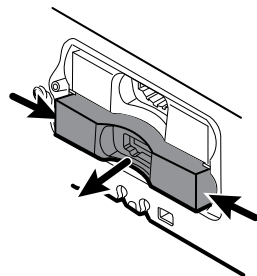

6. Disconnect the USB cables from the rear of each module.

Reassembly notes

- When aligning the module with the housing, the USB connection is on the left.
- The NIBP module must always be in the front-most slot.

Remove the module well

Option 1. Complete the following preliminary steps if your goal is to replace the front housing:

- Power down the system and disconnect the AC power cord.
- Remove the system from the wall and remove the battery.
- Remove the handle module assembly.
- Open the chassis.
- Remove the light bar.
- Remove the power panel.
- Remove the power wire harness and the main wire harness.
- Remove the modules in the bottom housing.

Option 2. Complete the following preliminary steps if your goal is to replace the power button:

- Power down the system and disconnect the AC power cord.
- Remove the system from the wall and remove the battery.
- Remove the handle module assembly.
- Open the chassis.
- Remove the modules in the bottom housing.

1. Disconnect the USB cables from the connectors on the main board in positions 5 and 6.

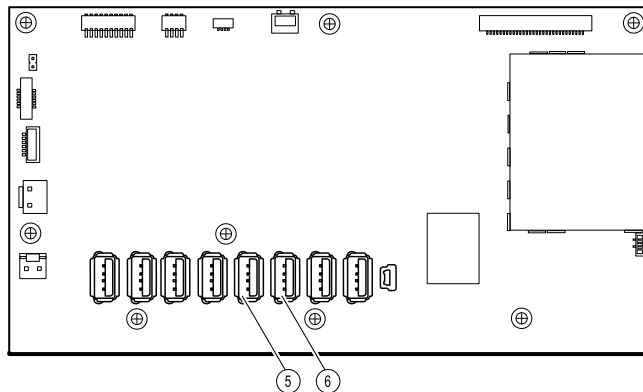

2. Remove the Torx screws on both sides of the module well.

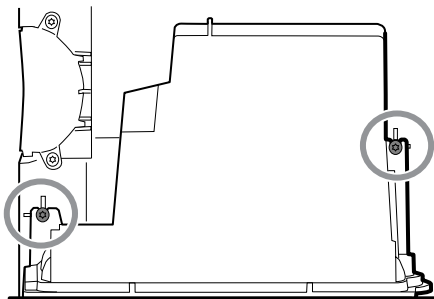

3. Remove the module well from the front housing. Remove the attached USB cables if necessary.

Reassembly notes

- Route USB cables properly:
 - Route cables through the module well to the correct corresponding module.
 - Route the NIBP and SpO2 USB cables over the Ethernet cable.
- Connect USB cables properly:
 - The NIBP module must be connected to USB position 6 on the main board.
 - The SpO2 module must be connected to USB position 5 on the main board.
- Place the USB cables in the 9-hole separator with the end that will connect to the main board extending approximately two inches. When positioning the USB cable separator on the main board, place the left end in the space marked for the cable separator as shown.

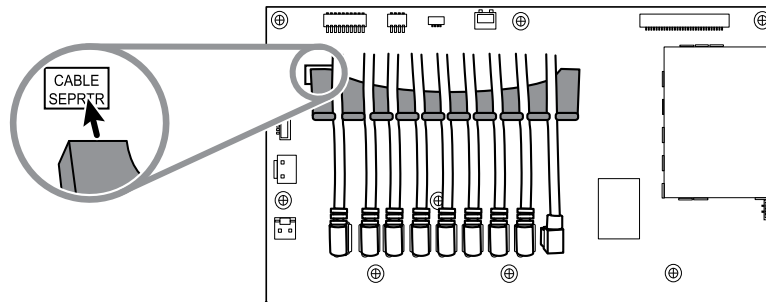

Module USB connectors

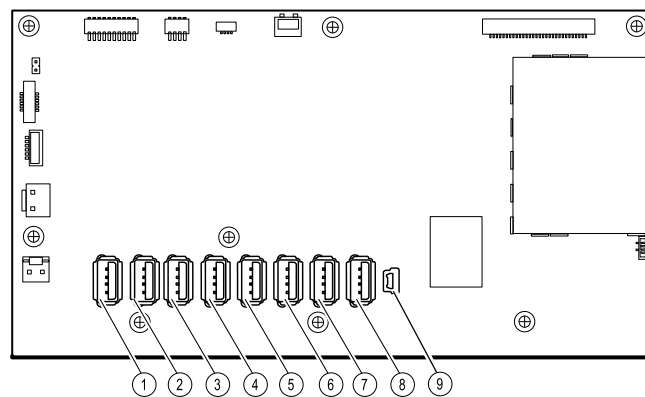

USB slot	Material number	Connection
1	717575	MCE to modules—Braun if installed
2	715891	MCE to modules
3	715891	MCE to modules
4	715891	MCE to modules

USB slot	Material number	Connection
5	715891	MCE to SpO2
6	715891	MCE to NIBP
7	712980	MCE to communications board
8	715891	MCE to handle module PCBA
9	713282	MCE to communications

Replace the power button

Complete the following preliminary steps:

- Power down the system and disconnect the AC power cord.
 - Remove the system from the wall and remove the battery.
 - Remove the handle module assembly.
 - Open the chassis.
 - Remove the modules in the bottom housing.
 - Remove the module well.
1. Disconnect the power button flex cable from the main board at J6.
 2. Peel off and discard the power button from the front housing.
 3. Thoroughly clean the housing surface with isopropyl alcohol before applying the new power button.
 4. Completely remove the adhesive from the rear of the new power button.
 5. Route the power button flex cable through the slot on the front of the system and firmly press the power button in the recessed well of the front housing.

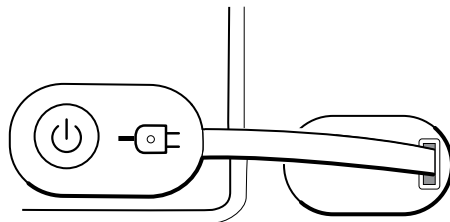

6. Connect the power button flex cable to J6 on the main board.

Replace the front housing

Complete the following preliminary steps:

- Power down the system and disconnect the AC power cord.
- Remove the modules in the main housing.
- Remove the system from the wall and remove the battery.
- Remove the handle module assembly.

- Open the chassis.
 - Remove the light bar.
 - Remove the power panel.
 - Remove the power wire harness and the main wire harness.
 - Remove the modules in the bottom housing.
 - Remove the module well.
1. Disconnect all USB connections from the main board.
 2. Remove the bundled USB cables from the housing by removing the two large Phillips screws.

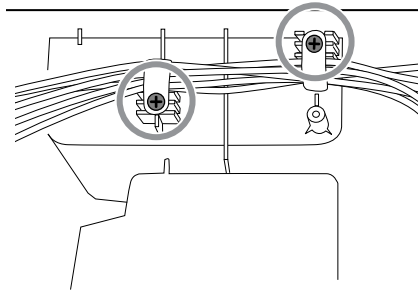

3. Disconnect the power button cable from the main board at J6.
4. Disconnect and remove the Ethernet cable.

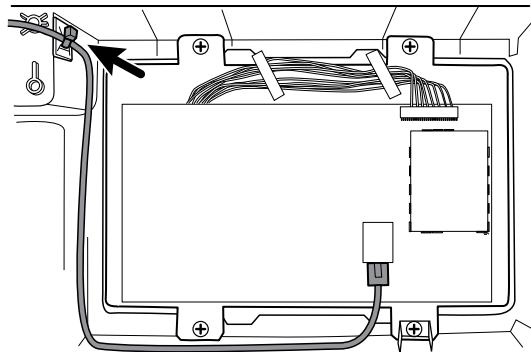

5. Remove the four large Phillips screws that mount the LCD to the housing.

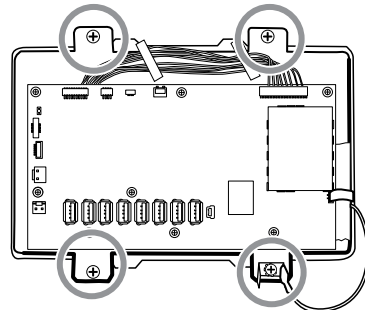

6. Carefully lift the LCD and the attached main board from the housing.



CAUTION Support the LCD as you lift the assembly from the housing. The LCD is not secured to the assembly.

7. Remove the two module tracks by removing the four Torx screws.

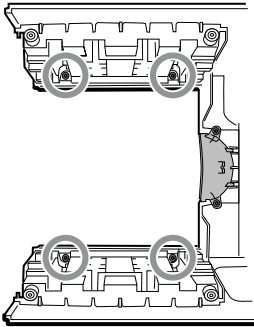

Functional verification and calibration

Functional verification tests

The functional verification tests help to confirm the proper operation of the device and its options. The tests may also be useful as a diagnostic tool to help isolate a malfunction. It is not necessary to disassemble the device to perform these tests.

For periodic service, you can—at a minimum—perform the basic functional verification tests described in this manual. These tests are for customers who have the Standard unlicensed edition of the Welch Allyn Service Tool. If you have the Gold licensed edition of the service tool, use the tool to perform a complete functional verification and calibration of the device in lieu of performing the basic tests.



NOTE To document basic functional verification tests, print out the "Service record" sheets at the end of this manual and record the test results.

Any time you open the case, you must use the service tool, Gold licensed edition, to perform a complete functional verification and calibration of the device before returning the device to service.



NOTE For instructions on using the Gold licensed edition, see the service tool help files.

About the Welch Allyn Service Tool

The service tool is required to complete functional verification and calibration tests. The service tool is available in the following editions:

- **Standard unlicensed edition:** Enables NIBP functional verification tests to satisfy the recommended annual service. If any Standard unlicensed edition testing shows an out-of-specification result, use the Gold licensed edition to perform a full calibration.
- **Gold licensed edition:** Checks the functionality and calibration of the device. As it checks the device, the Gold licensed edition also performs any needed calibration to bring the device within specifications. This full suite of tests is required to complete a repair. Each time you open the case, you must use the Gold licensed edition to test the device before returning the device to normal use.

For information about the service tool, see the following:

- For instructions on installing and using the service tool, see the *Welch Allyn Service Tool Installation and Configuration Guide*.
- To use the Standard unlicensed edition to test the NIBP module, follow the instructions in this service manual.

- For instructions on using the Gold licensed edition, see the service tool help files.

Standard unlicensed edition service tool tests performed

The service tool performs the following functions on the host device and installed options.

Test	Description	NIBP	Temp	SpO2	SpHb	Host
Reads firmware	Displays the firmware version	✓	✓	✓	✓	✓
Firmware upgrade	Loads the latest firmware into the module	✓	✓	✓	✓	✓
Leak test	Verifies leaks using 100 cc volume	✓				
Accuracy test (NIBP)	Checks the accuracy of transducers across the pressure range	✓				
Overpressure test	Verifies the maximum cuff pressure for adults and neonates	✓				

Gold licensed edition service tool tests performed

The service tool tests the host device and installed options as listed in the following table.

Test	Description	NIBP	Temp	SpO2	SpHb	Host
POST	Performs the power-on self test (POST) ¹	✓	✓	✓		✓
Firmware version	Checks the firmware version	✓	✓	✓		✓
Firmware upgrade	Loads the latest firmware into the module	✓	✓	✓		✓
Leak	Verifies leaks using 100 cc volume	✓				
AD noise	Checks noise on the pressure channel	✓				
Calibration	Calibrates pressure transducers	✓				
Accuracy (NIBP)	Checks the accuracy of transducers across the pressure range	✓				
Dump	Checks dump valves	✓				
Inflation	Verifies the pneumatic pump	✓				

Test	Description	NIBP	Temp	SpO2	SpHb	Host
Valve control	Verifies control of the system valve	✓				
Overpressure	Verifies pump limits	✓				
Probe detect	Verifies the operation of the probe detect switch ²		✓			
Accuracy (Temp)	Verifies the accuracy of the thermometer across range		✓			
Functional check	Verifies module operation with cal-key ²		✓			
Masimo SpO2 and SpHb functional check	Verifies module operation with rainbow SET tester			✓	✓	
Display	Verifies video output					✓
Back light interface	Verifies display LED back light					✓
Touchscreen interface	Verifies touchscreen calibration interface					✓
LED	Verifies the light bar amber and red LED strings					✓
Fan interface	Verifies fan operation					✓
Beeper	Verifies the buzzer					✓
Nurse call relay	Verifies the nurse call relay					✓
Battery operation	Verifies the internal battery					✓
Speaker	Verifies the speaker					✓
USB host port communication	Verifies the USB ports					✓
Ethernet communication	Verifies the Ethernet port					✓

¹ POST testing checks the following:

- **NIBP:** ROM, RAM, A/D channels, calibration, and user configuration.
- **Temperature:** ROM, RAM, calibration, and heater.
- **SpO2:** ROM and RAM, and connection to the SpO2 board.

² SureTemp Plus only.

³ Normal mode.

Basic functional verification checks



NOTE Calibration is available only with the service tool, Gold edition.

The basic functional verification test using the Welch Allyn Service Tool Standard edition meets the minimum requirements for routine preventive maintenance. These tests verify basic functionality of the NIBP, SpO₂, SpHb, and thermometry parameters. Welch Allyn recommends using the service tool, Gold edition, to perform verification of the device when completing a repair.

Basic functional verification check tools

Listed below are the all the tools required to perform the basic functional test.

Material no.	Description	Qty	Component
407672	BP test volume repair fixture 113670	1	NIBP
N/A	SpO ₂ simulator	1	Masimo and Nellcor SpO ₂
DOC-10	Cable, SpO ₂ extension, Nellcor	1	Nellcor SpO ₂
06138-000	Cal-key, assembly, M690/692	1	SureTemp Plus Thermometry Module
01802-110	Tester, calibration, 9600 Plus	3	Braun ear and SureTemp Thermometry Probe
411690	PRO 6000 calibration fixture* *Use with older models have a dust cover screw that rises above the O-ring washer. Newer models have a dust cover screw that is recessed into the washer.	3	Braun ear
N/A	Pressure meter (must include at least two decimal points and be accurate to within ± 0.5 mmHg)	1	NIBP
4500-925	USB 2.0/5-pin Mini-B cable, gold, 6 ft.	1	NIBP, Software updates
6000-30	Single tube blood pressure hose, 5 ft.	1	NIBP
N/A	PC running the Welch Allyn Service Tool on Windows 10	1	ALL
web download	Welch Allyn Service Tool https://www.hillrom.com/en/services/welch-allyn-service-tool/	1	NIBP, Software updates and calibration
N/A	Blood pressure Y-tube	1	NIBP
4500-30	Blood pressure hose, 5 ft.	1	NIBP

Material no.	Description	Qty	Component
620216	Fitting "Y" 1/8 X 1/8 X 1/8	1	NIBP
N/A	ECG patient simulator calibrated to ISO/IEC standards with defined amplitudes for Lead I, Lead II, Lead III, and Lead IV when using a 5-lead patient cable -OR- an ECG patient simulator with defined amplitudes for Lead I, Lead II, and Lead III when using a 3-lead patient cable.	1	ECG

Full functional verification check and calibration tools

The list of tools below is what is required to perform a full device functionality check and calibration. The tools are used in conjunction with the Welch Allyn service tool, Gold licensed edition, to perform a device calibration.

Material no.	Description	Qty	Component
01802-110	Tester, calibration, 9600 Plus	3	Braun ear and SureTemp Thermometry Probe
407672	BP test volume repair fixture 113670	1	NIBP
411690	PRO 6000 calibration fixture* *Use with older models have a dust cover screw that rises above the O-ring washer. Newer models have a dust cover screw that is recessed into the washer.	3	Braun ear
N/A	SpO2 simulator	1	Masimo and Nellcor SpO2
LNCS-DC1	SpO2 cable and finger sensor	1	Masimo SpO2
DS-100A	SpO2 finger sensor	1	Nellcor SpO2
DOC-10	Cable, SpO2 cable extension, Nellcor	1	Nellcor SpO2
06138-000	Cal-key, assembly, M690/692	1	SureTemp Thermometry Module
N/A	Pressure meter (must include at least two decimal points and be accurate to within ± 0.5 mmHg)	1	NIBP
4500-925	USB 2.0/5-pin Mini-B cable, gold, 6 ft.	1	NIBP
106270	Service test box	1	Nurse Call, USB ports
660-0138-00	Cable, patch 5 feet RJ45, T568B	1	Ethernet Test
407022	Assy, MMF Nurse call cable - service	1	Nurse Call (Service Test Box Required)

Material no.	Description	Qty	Component
N/A	USB cable Type A to Type B (3 ft.)	1	USB Ports (Service Test Box Required)
6000-30	Single tube blood pressure hose, 5 ft.	1	NIBP
N/A	Wireless router, a/b/g or equivalent	1	Wired & Wireless Test
N/A	PC running Windows 10	1	All
web download	Welch Allyn Service Tool (version 1.8 or later) Click this link	1	NIBP, Software updates
N/A	Blood pressure Y-tube	1	NIBP
4500-30	Blood pressure hose, 5 ft.	1	NIBP
620216	Fitting "Y" 1/8 X 1/8 X 1/8	1	NIBP

Create a blood pressure Y-tube

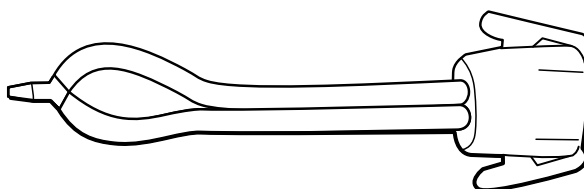

The blood pressure Y-tube is a piece of custom test equipment that connects the device to the test setup. The Y-tube is composed of a modified blood pressure hose and a Y-type fitting. Follow these instructions to create a Y-tube.

1. Cut a 4500-30 blood pressure hose approximately 6 inches from the connector that connects to the device.
2. Split the end of the dual-lumen hose to create two separate hoses. Make sure not to puncture either hose.
3. Insert one end of the Y-type fitting into each end of the hose.

NIBP test setup

For the NIBP leak test, overpressure test, or accuracy check, connect the test equipment shown below. Connect the manifold to the volume repair fixture as indicated by the service tool or the test procedure.

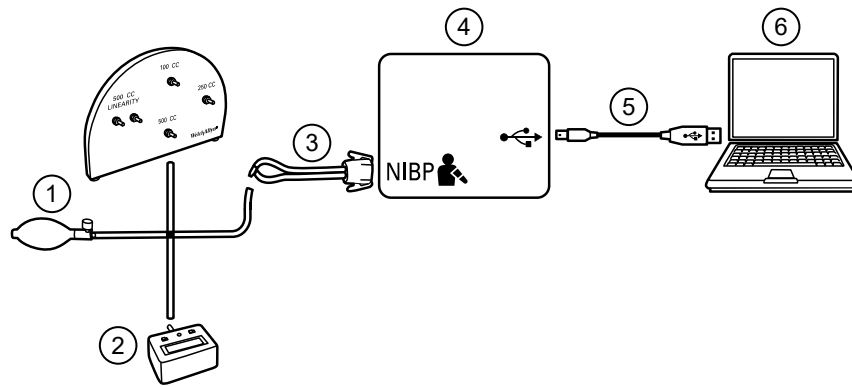

No.	Item	No.	Item
1	Test volume repair fixture with test manifold, bulb, and valve	4	Device
2	Pressure meter	5	USB 2.0/5-pin type A to mini-B cable
3	Blood pressure Y-tube	6	PC

NIBP leak test (Standard unlicensed edition)

The NIBP leak test is performed automatically using the service tool. The leak test pressurizes the system with a start pressure (P_s) of 250 mmHg \pm 10 mmHg. After 15 seconds (T_t) the end pressure (P_e) is measured. The leak rate is calculated using the formula $L = (P_s - P_e) / T_t$. The test fails if the leak rate exceeds 5 mmHg in 15 seconds.

Perform an NIBP leak test

1. Set up the test equipment.
2. Launch the service tool on the PC.
3. If the simplified interface is active, choose the Service option.
4. Log on with your user ID and password or with ADMIN as the user ID and leave the password field blank.
5. Power on the device.
6. Select the device you want to test from the device list.
7. Click **NIBP Sensor** under the Device Information tab.
8. Click **Leak Test** in the NIBP Sensor pane on the right side of the window.
9. Follow the prompts until the test completes.
10. Click **Close**.
11. To view the results, open the active log file by selecting **File > View Log File > Active log file > Ok**.
12. To record the results of your test, go to "Service record."

NIBP overpressure test (Standard unlicensed edition)

The NIBP overpressure test is performed automatically using the service tool. The overpressure test verifies that the NIBP system will prevent the pressure from exceeding 329 mmHg in adult mode and 164 mmHg in neonate mode. To pass this test, the device must shut down the pump and open the valves when the pressure is between 280 mmHg and 329 mmHg in adult mode, or 130 mmHg to 164 mmHg in Neonate mode.

Perform an NIBP overpressure test



NOTE If you are performing this test after performing the NIBP leak test, skip to step 7.

1. Set up the test equipment.
2. Launch the service tool on the PC.
3. If the simplified interface is active, choose the Service option.
4. Log on with your user ID and password or with ADMIN as the user ID and leave the password field blank.
5. Power on the device.
6. Select the device you want to test from the device list.
7. Click **NIBP Sensor** under the **Device Information** tab.
8. In the NIBP Sensor pane on the right side of the window, click **Over Pressure Test**.
9. Follow the prompts until the test completes.
10. Click **Close**.
11. To view the results, open the active log file by selecting **File > View Log File > Active log file > Ok**.
12. To record the results of your test, go to "Service record."

NIBP accuracy check (Standard unlicensed edition)

The NIBP accuracy check is performed manually using the service tool to control the valves. The accuracy check compares the reading from the primary transducer pressure shown in the service tool window with the reading from an external calibrated digital pressure meter. The results of this check are not recorded in the service tool log file. To record the results for your records, copy the table in the service record section of the service manual. If a calibration is required, run the NIBP calibration included with the Gold licensed edition of the service tool.



WARNING Patient safety risk. If the primary transducer fails, the system might not identify an overpressure condition at the right limit, causing injury when the device is re-connected to a patient. To ensure patient safety, Welch Allyn recommends that a qualified service technician perform a full functional verification and calibration on an annual basis.



CAUTION Equipment calibration error can occur. This accuracy check verifies only the accuracy of the primary transducer. If the safety transducer is out of calibration, a calibration error can occur due to the pressure difference between the primary transducer and the safety transducer. To avoid equipment calibration errors, Welch Allyn recommends that a qualified service technician perform a full functional verification and calibration on an annual basis.

Perform an NIBP accuracy check



NOTE If you are performing this test after performing a previous NIBP check, skip to step 7.

1. Set up the test equipment.
2. Launch the service tool on the PC.
3. If the simplified interface is active, choose the Service option.
4. Log on with your user ID and password or with ADMIN as the user ID and leave the password field blank.
5. Power on the device.
6. Select the device you want to test from the device list.
7. Click **NIBP Sensor** under the **Device Information** tab.
8. Click **Accuracy Check** in the NIBP Sensor pane on the right side of the window.
9. Connect the 500cc volume.
10. Turn on the pressure meter and zero if necessary.
11. Check the accuracy at 0 mmHg.
12. Record the reading on the pressure meter and the service tool and compare the results.
13. Using the hand bulb, pressurize the NIBP system to 50 mmHg \pm 5 mmHg and allow 10 seconds for the pressure to stabilize.
14. Record the reading on the pressure meter and the service tool and compare the results.
15. Using the hand bulb, pressurize the NIBP system to 150 mmHg \pm 5 mmHg and allow 10 seconds for the pressure to stabilize.
16. Record the reading on the pressure meter and the service tool and compare the results.
17. Using the hand bulb, pressurize the NIBP system to 250 mmHg \pm 5 mmHg and allow 10 seconds for the pressure to stabilize.
18. Compare the reading on the pressure meter to the service tool reading and record the results.
19. Click **Open valve** to open the NIBP valves. Verify that the pressure on the meter and service tool change to zero.
20. Click **Done** to complete the check.
21. To record the results of your test, go to "Service record."

SpO2 and SpHb tests

Use this procedure to test the device's SpO2 and SpHb functions, if included.

Perform a Masimo SpO2 and SpHb test

1. Power on the device.
2. Touch the **Settings** tab.
3. Touch the **Device** tab.
4. Touch **Intervals Monitoring**.
5. Touch the **Home** tab.
6. Connect the SpO2 simulator to the device.
7. Verify the following on the simulator:
 - The default pulse rate is 60 bpm and the default SpO2 is 81%.

8. Give the device up to 30 seconds to stabilize and then verify a displayed pulse rate of 60 bpm \pm 1 bpm and a displayed SpO₂ of 81% \pm 3%.
9. If the SpHb option is active, verify that the parameter is displayed with a reading of 14 g/dL \pm 1 g/dL.

Perform a Nellcor SpO₂ test

Use this procedure to test only the device SpO₂ function.

1. Power on the device.
2. Connect the SpO₂ simulator to the SpO₂ input connector through a Nellcor DOC-10 extension cable.



NOTE In the following tests, if the defaults are outside the device alarm limits, readjust the limits or silence the alarms.

3. Verify the following on the simulator:
 - The default pulse rate is 60 bpm and the default SpO₂ is 90%.
4. Give the device up to 30 seconds to stabilize, and verify a displayed pulse rate of 60 \pm 1 bpm and a displayed SpO₂ of 90% \pm 1 sat point.
5. Disconnect the SpO₂ simulator.

SureTemp temperature system test

The SureTemp temperature system test is performed using a calibration key (cal-key). The calibration key tests the system using a fixed resistance to display a temperature of 97.3 \pm 0.3 °F (36.3 \pm 0.2 °C).

Perform a SureTemp temperature system test

1. With the system power on and the temperature probe in the well, disconnect the probe cable from the temperature input connector on the front of the device.
2. Connect the calibration key to the temperature input connector.
3. Remove the probe from the well.
4. Verify that the displayed temperature is 97.3 \pm 0.3 °F (36.3 \pm 0.2 °C).

SureTemp temperature probe and system test

Use this procedure to test the temperature function while verifying the temperature probe. To achieve accurate results, you must perform this test with the device in Direct mode.

Test each probe at the low, medium, and high set points on the tester. Repeat the procedure for each thermometer and temperature to test.

Set up the 9600 Plus calibration tester

Place the tester on a level surface away from sunlight, drafts, and other sources of heat or cold.

The tester takes approximately 20 minutes to heat to the lowest set point.

To expedite testing, Welch Allyn recommends the following practices:

- To eliminate waiting for the tester to heat to the next set point, use three testers, each set to one of three different set points.

- When using only one tester to test several thermometers at all three temperatures, test all thermometers at one set point before proceeding to the next set point.
- To eliminate waiting for the tester to cool down, start at the lowest set point. Because the tester does not have an internal fan, it requires more time to cool down than to heat up.

Change the 9600 Plus set point

To scroll from one set point to the next, press and hold the Temperature Selection button until a beep sounds.

The new set point appears in the upper left corner of the display. The device's current temperature appears, flashes, and continues flashing until the cavity reaches equilibrium at the new set point. The 9600 Plus beeps when the set point is reached.

Perform a SureTemp temperature probe and system test

1. Set the 9600 Plus to the desired set point and wait for the display to stop flashing.
2. Insert the temperature probe, without a probe cover, into the thermistor device port on the tester.



3. When  appears on the display, touch it to switch to Direct mode.
4. Wait for up to two minutes for the temperature reading to stabilize.
5. Record the results in the temperature service record.
6. Return the temperature probe to the probe well on the device.
7. Repeat the procedure as necessary until all thermometers are tested at each temperature.

To record the results of your test, go to "Service record."

Braun ThermoScan PRO thermometer tests

This explains how to perform a functional verification on the Braun ThermoScan PRO 4000 and Braun ThermoScan PRO 6000 thermometers using the 9600 Plus Calibration Tester.



NOTE Use this procedure in place of the verification and calibration test for the Braun PRO 4000 and Braun PRO 6000 in the Welch Allyn Service Tool version 1.0.2.0 and earlier.



CAUTION Before the test, place thermometers and tester in the same room for approximately 30 minutes so that they adjust to the ambient temperature.



CAUTION Set the temperature scales on the 9600 Plus to match the Braun ThermoScan PRO's default temperature scale.



CAUTION Set up the 9600 Plus away from sunlight, drafts, and other sources of heat or cold. Fluctuations will impact the calibration check.



CAUTION The ambient temperature must be stable and within the range of 18.3°C (65.0°F) to 26.7°C (80.0°F).

For more information, see the *Welch Allyn 9600 Plus Calibration Tester Directions for use*.

Perform a Braun ThermoScan PRO 4000 functional verification test

Test each thermometer at the low, medium, and high set points on the tester. After placing the thermometer in calibration mode, repeat the procedure from step 4 for each thermometer and temperature to be tested.

1. Complete the following pre-check steps:
 - a. Check the probe tip lens window with a magnifying glass for signs of displacement. Any gaps in the seam between bezel and the lens window indicate a displaced lens window. If you see a gap, the unit is damaged and must be replaced.
 - b. Gently wipe the probe tip with a cotton swab slightly moistened with 70 percent isopropyl or ethyl alcohol, taking care not to displace the lens window. Remove excess alcohol with a clean cotton swab, and let air dry for 5 minutes. Do not use any chemical other than alcohol to clean the probe window.
 - c. Verify that the thermometer is fully charged.
2. Place the thermometer in calibration mode:
 - a. Make sure that the thermometer displays the OFF symbol.
 - b. Turn on the thermometer by pushing and releasing **I/O mem**.
Symbols and functions appear as the thermometer performs an automatic self check.
 - c. Wait for two dashes and °C or °F to appear on the display.
 - d. Push and hold **I/O mem**.
After approximately 3 seconds, a short beep sounds, and the OFF symbol flashes on the display. Then a long beep sounds.
 - e. Release the button immediately.
The display flashes and shows the CAL symbol.
The thermometer is now in calibration check mode.
3. Apply a new probe cover. Place the probe firmly into the Ear Device Port.
4. Wait approximately 3 seconds, and then press the **Start** button.
The ExacTemp light flashes.
5. Leave the thermometer in the tester until a beep sounds.
6. Remove the thermometer from the tester and read the temperature in the thermometer's display. If the temperatures are within ± 0.2 °C (± 0.4 °F) of the tester's set point, the thermometer is within calibration.
7. Record the results in the thermometer service record.
8. Press the **Start** button once to clear the previous reading.
9. Wait 1 minute, and then take another reading with the same thermometer.



NOTE Repeated measurements in short sequence might cause higher readings.



NOTE If using only one tester, test all available thermometers for calibration verification at the current set point before raising the set point.

10. Repeat the procedure from step 4 as necessary until all thermometers are tested at each temperature.
11. Exit CAL mode using one of the following methods:
 - Press and hold the **I/O mem** button until the OFF symbol flashes.

- Wait for 4 minutes. The thermometer automatically exits CAL mode.

To record the results of your test, go to "Service record."

Perform a Braun ThermoScan PRO 6000 functional verification test

1. Complete the following pre-check steps:
 - a. Check the probe tip lens window with a magnifying glass for signs of displacement. Any gaps in the seam between bezel and the lens window indicate a displaced lens window. If you see a gap, the unit is damaged and must be replaced.
 - b. Gently wipe the probe tip with a cotton swab slightly moistened with 70 percent isopropyl or ethyl alcohol taking care not to displace the lens window. Remove excess alcohol with a clean cotton swab, and let air dry for 5 minutes. Do not use any chemical other than alcohol to clean the probe window.
 - c. Verify that the thermometer is fully charged.
2. Place the thermometer in calibration mode:
 - a. With the thermometer in sleep mode, press and release the **C/F** button.
 - b. Immediately (while all segments of the LCD are illuminated during self-test), press and hold the **C/F** button and the **Mem** button.

After 5 seconds the thermometer begins a long beep.
 - c. During the beep, release the **Mem** button and the **C/F** button.

The thermometer is now in Calibration check mode. ("CAL" flashes on the screen for 0.25 seconds every second.)

3. Return the thermometer to the dock or a flat surface and wait for 1 minute before taking the first temperature.



NOTE Holding the thermometer could raise the temperature of the thermometer. Put the thermometer down while waiting so that the thermometer remains at ambient room temperature.

4. Apply a new probe cover.

When the probe cover is applied properly, the flashing probe cover icon disappears from the display and a short beep sounds.

5. Wait for the screen to flash three dashes (---) alternating with "CAL."
6. Place the probe firmly into the ear device port or Braun 6000 test fixture. Firmly push the device down into the well to ensure perpendicularity and that the probe is fully seated in the device port. Visually check the thermometer and fixture to ensure proper alignment.



NOTE When using the Braun 6000 test fixture, follow the instructions provided with the fixture to position the PRO 6000 in the test fixture.



NOTE If you are not using the Braun 6000 test fixture, ensure that the device is perpendicular in the port, directly aligned with the calibration tester sensor, and not at an angle or tilted.



NOTE Once the device is firmly seated, do not apply additional pressure. Doing so may cause your hand to waver and tilt or move the device during testing.

7. Wait 5 seconds, press the thermometer measure button, and watch for the green ExacTemp light to flash.

8. Leave the thermometer in the 9600 Plus Calibration Tester until the ExacTemp light stops flashing and you hear a beep.
9. Remove the Braun PRO 6000 thermometer from the 9600 Plus Calibration Tester and compare the temperature displayed on the tester with the temperature on the thermometer's display.
If the temperatures are within ± 0.2 °C (± 0.4 °F), the thermometer is within calibration.
10. Replace the probe cover to reset, and wait for the thermometer screen to flash three dashes (---) alternating with "CAL."



NOTE Replace the probe cover before each reading to remove any residual heat absorbed from the 9600 Plus Calibration Tester.

11. Return the thermometer to the dock or a flat surface and wait 1 full minute before taking another reading with the same thermometer.



NOTE Repeated measurements in short sequence might cause higher readings.



NOTE Holding the thermometer could raise the temperature of the thermometer. Put the thermometer down while waiting so that the thermometer remains at ambient room temperature.

12. Test all available thermometers for calibration verification at the current calibration set point temperature before proceeding to the next calibration set point temperature.
13. See the 9600 Plus Calibration Tester DFU to change the set point temperature.



NOTE The device will exit CAL mode after 10 minutes of inactivity or can be forced to exit by holding both **C/F** and **Mem** for 5 seconds. After exiting Calibration Check Mode, the thermometer returns to Sleep Mode.

To record the results of your test, go to "Service record."

ECG functional test

The ECG module does not require any calibration or routine maintenance other than cleaning. This functional test should be performed to verify the ECG module is functioning properly after the Connex device case has been opened or you suspect a problem.

Required equipment

- Connex device with software version 2.30.01 or later
- Welch Allyn Connex Devices ECG module
- 5-lead AHA or IEC cables
- Stopwatch
- Clinical Dynamics AccuSim patient simulator or equivalent

ECG simulator requirements:

- Supports outputs for Lead RA, Lead LA, Lead LL, Lead RL, and Lead V when using a 5-lead patient cable
- Generates heart rate between 20 and 300, inclusive
- Generates ECG amplitude between 0.5 mV and 5.0 mV, inclusive
- Generates ECG width between 40 ms and 120 ms, inclusive
- Generates irregular rhythms (Asystole, V-Tachycardia, V-Fib)

General acceptance criteria

- Heart Rate: within +/- 3 beats per minute or +/- 3%, whichever is greater
- Respiration Rate: within +/- 2 breaths per minute or +/- 2%, whichever is greater
- Asystole alarm triggers in 4 seconds or longer

Test setup

Configure the ECG simulator

1. Normal Sinus Rhythm (NSR)
 - a. Heart rate 80 beats per minute
 - b. Amplitude 1.00 mV
 - c. Mode Continuous (AccuSim simulators)
2. Respiration
 - a. Rate 15 breaths per minute
 - b. ΔR : 1.5 ohms
 - c. Base impedance 250 ohms
 - d. Apnea: Off

Connex device and ECG module

1. Disconnect all parameter sensors from the device, if connected.
2. Connect the Connex device to AC power and power on.
3. Restore settings on the Connex device to factory default and restart the device.
 - a. Touch the **Settings** tab.
 - b. Touch the **Advanced** tab.
 - c. Enter **6345** or the custom password for the device.

NOTE Restoring factory defaults will not reset the password.
 - d. Touch the **Service** tab.
 - e. In the Restore factory defaults pane, touch **All settings**.
 - f. Touch **OK** to confirm the change and restart the device.
4. If the device does not open to Advanced settings after restart, repeat substeps 3a. through 3c.
5. Touch the **Device** tab and adjust settings as follows:
 - a. Set the power line frequency to match your AC power frequency (50Hz or 60Hz).
 - b. Set the default profile to Continuous monitoring.
6. Touch the **Parameters** tab and then the **ECG** vertical tab.
7. Configure ECG settings as follows:
 - a. Set Cable selection to **5 Lead**.
 - b. Set electrode configuration to match the patient cable used with this test.
 - c. Enable **Allow impedance respiration**.
 - d. Enable **V-Tach, V-Fib, Asystole detection**.
 - e. Enable **Automatic print on ECG alarm**.
 - f. Set Default lead to **II**.
 - g. Set the V-Tach threshold to **120**.
8. Touch **Exit** to leave Advanced settings.
9. Connect the ECG module to one of the USB host ports on the Connex device.
10. Touch the **Settings** tab, then the **Device** tab, then the **Profiles** vertical tab.
11. Set the profile to continuous monitoring.
12. Touch the **Settings** tab, then the **Setup** tab, then the **ECG** vertical tab.
13. Configure ECG settings as follows:

- a. Set ECG gain to 20 mm/mv.
- b. Set sweep speed to 25 mm/s.
- c. Enable Filter.
14. Touch the **Device** tab, then the **Defaults** vertical tab.
15. Touch **Save as default** in the Current settings pane.
16. Power off the Connex device.
17. Use either a 5-lead AHA or IEC ECG cable to connect the ECG module to the corresponding AHA or IEC connections on the simulator.

ECG test procedure

Inspect the ECG module and cables. Capture the results in the ECG Test Record worksheet and compare results to the acceptance criteria to determine if the step passes or fails. If you determine that the cable is faulty, replace it with a known good cable and repeat the test.

Inspect the ECG module and cables

Before performing a functional test, inspect the module and cables.

1. Inspect the ECG patient cables for the following:
 - a. Cuts to insulation or connectors
 - b. Cracks or discoloration of the plastic
 - c. Missing or loose rubber or plastic
 - d. Missing or damaged labels
2. Inspect the ECG USB cable for the following:
 - a. Cuts to insulation or connectors
 - b. Cracks or discoloration of the plastic
 - c. Missing or loose rubber or plastic
 - d. Missing or damaged labels
3. Inspect the ECG module for the following:
 - a. Broken plastic
 - b. Cracks
 - c. Discoloration
 - d. Missing or damaged fasteners
 - e. Missing or damaged labels
 - f. Broken internal parts as evidenced by rattles
 - g. Broken, bent, burnt, contaminated, or corroded connector pins
 - h. Discoloration around connector pins

ECG module and LED test

1. Verify that the LED on the ECG module is off. Record result.
2. Power on the Connex device and observe the LED on the ECG module.
3. Verify that the LED on the ECG module initially lights up amber then changes to steady green. Record result.
4. On the Connex device Home tab, touch **Start** in the ECG frame.
5. Verify that the LED on the ECG module is flashing green. Record result.

Waveform and heart rate test

1. Touch the ECG frame on the Connex device display until the selected lead is Lead I.
2. Touch **Start** in the ECG frame.
3. Verify that a waveform appears and that heart rate is 80 beats per minute +/- 3 beats per minute. Record result.

The ECG NSR waveform for Lead I and HR/PR should appear as shown.

ECG Lead I



4. Touch the ECG frame to change the ECG lead.
5. Repeat steps 3 and 4 for Leads II, III, and V.



NOTE The waveform will vary for each lead, as shown.

ECG Lead II



ECG Lead III



ECG Lead V



Lead-off alarm test

1. Remove one lead from the simulator and verify that the monitor displays an equipment alert identifying the failed lead. Record result.
2. Replace the lead and wait for the waveform to stabilize again.
3. Repeat steps 1 and 2 for each lead (AHA or IEC leads RA/R, LA/L, RL/N, LL/F, V/C).

Respiration test

1. Touch the **Settings** tab, then the **Setup** tab, then the **ECG** vertical tab.
2. Configure ECG settings as follows:
 - a. Set ECG gain to **20 mm/mv**.
 - b. Set sweep speed to **25 mm/s**.

- c. Enable **Filter**.
- d. Disable **Patient has a pacemaker**.
- e. Enable **Use ECG as an RR source when available**.
3. Touch the **Home** tab.
4. Touch the ECG frame on the Connex device display until the lead switches to Lead II.
5. Allow 3 minutes for the ECG signal to stabilize before observing heart rate and respiration rate.
6. Verify that the respiration rate is 15 breaths per minute +/- 2 breaths per minute. Record result.

Arrhythmia alarm test

1. On the Connex device display, touch **Stop** in the ECG frame.
2. Set the ECG simulator to trigger an Arrhythmia.
3. Touch **Start** in the ECG frame.
4. Trigger the Asystole on the ECG simulator and start the stop watch to capture the time elapsed between triggering the Asystole and the Asystole alarm appearing on the Connex device.
5. Verify that the Asystole alarm triggers after ≥ 4 seconds. Record result.
6. Touch **Stop** in the ECG frame.
7. Turn off Asystole on the ECG simulator and resume a normal sinus rhythm.

Pacemaker detection test

1. Touch the **Settings** tab, then the **Setup** tab, then the **ECG** vertical tab.
2. Enable **Patient has a pacemaker**.
3. Touch the **Home** tab.
4. Observe the PACER DETECTION ON label in the ECG frame.
5. Turn on the Pacemaker signal on the ECG simulator.
6. Set the following Atrial Pacer settings:
 - a. Polarity ve+
 - b. Width 1 ms
 - c. Amp 5.0 mv
 - d. Pacer and ECG synced
7. Set the ECG channel to Lead I.
8. Touch **Start** in the ECG frame.
9. Wait a few seconds and observe the waveform in the ECG frame.
10. Verify that the Pacer spike marker appears before the QRS complex in the ECG frame. Record result.
11. Repeat steps 7 through 10 for Lead II, Lead III, and Lead V.

End of test.

Electrical safety testing

Welch Allyn recommends performing only ground continuity and leakage current tests after all open-case repairs. Dielectric strength testing is not recommended.



NOTE Perform dielectric strength testing only if there is a reason to doubt the integrity of the electrical insulation (e.g. multiple trips of a residual-current device or liquid ingress of a saline solution). If you determine this test should be performed, return the device to Welch Allyn for service.

These recommendations trace to EN/IEC 60601-1 – Medical Electrical Equipment – Part 1: General Requirements for Basic Safety and Essential Performance or EN/IEC 62353 – Medical Electrical Equipment – Recurrent Test and Test After Repair of Medical Electrical Equipment.

Because of the variability of test equipment in the field, Welch Allyn does not include specific instructions to perform electrical safety tests. When performing electrical safety tests, refer to your test equipment manuals for detailed instructions to ensure proper test equipment setup that aligns with the appropriate standard. The following table provides connections and test limits to assist you in performing these tests.

Test	Limits
Ground continuity (see Note above)	Ground continuity from EP stud (equipotential terminal)* to the Gnd pin of the IEC power connector shall be no greater than 0.1 ohms.
Leakage current (see Note above)	Leakage current shall be less than 500 μ A from EP stud* to mains (Line and Neutral pins of the IEC power connector).
Insulation resistance	Dielectric strength shall be 500 V (DC) EP stud* to IEC mains (Line and Neutral pins of the IEC power connector), and insulation resistance is measured.

* To locate the equipotential terminal, see "Controls, indicators, and connectors."

Devices with an external power supply

The power bricks are CB Certified and UL Listed; they meet ALL of the requirements that the Medical Device standard requires for power supplies. The manufacturer is required to perform 100% electrical safety testing on all of their power bricks prior to shipment. Welch Allyn does not perform nor recommend testing on these external power bricks because additional testing would put undue stress on the insulation system and possibly cause premature failures in the field. Open case repairs of devices with external power supplies are only dealing with DC circuitry and robust isolation circuits built into the printed circuit boards. No additional after-servicing testing is

required in that instance. The patient isolation systems within the device (Temperature Probe, SpO2 sensor, CO2 sensor, ECG sensor, etc.) all have visible isolation gaps built into the printed circuit board. The quality control on the PCB and the thorough type-testing performed by the testing agency (ETL) eliminates the need for further testing on the devices that are downstream from the mains isolation device.

Devices with an internal power supply

The internal power supplies are CB Certified and UL Registered. These power supplies are an open frame style (no protective enclosure). Therefore, the products that contain an internal power supply require electrical safety testing. Open case repairs of devices with an internal power supply require the recommended testing because those devices contain the open frame power supply, and the testing involves the manipulation of wiring that carries 120 or 240 volts AC. Welch Allyn does not recommend HiPot / Dielectric Withstand testing because of a potential stress on the insulation system, which could cause premature failures.

Ground stud connector

This device is equipped with a ground stud (equipotential terminal) for electrical safety testing, and to connect a potential equalization conductor. To ensure use of the proper connector for safety testing, the ground stud is recessed into the system's housing. Do not use "alligator" style clamps or connectors. The mating electrical connector requires self assembly by crimping it to appropriate connecting leads.

The mating connector (Type POAG-KBT6DIN, order number 15.0010) consists of the right-angled socket and insulator, as shown in the next figure. You can purchase the mating connector and the crimping pliers from the manufacturer, Multi-Contact:

<http://www.multi-contact.com>.

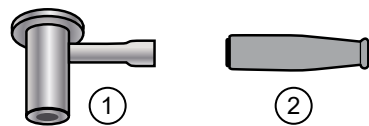

Item	Description	Type	Order no.
①	The mating electrical connector, a right-angled socket made of nickel-plated brass with Multilam™ made of gold-plated, hard-drawn copper alloy.	POAG-WB6DIN	01.0404
②	Insulator	T-POAG6	15.5004-24
	Crimping pliers with mandrel crimp for 4 mm ² and 6mm ² flexible conductors.	POAG-PZ-N	14.5009

Options, upgrades, and licenses

Welch Allyn supports option, software, and license upgrades for all models.

Option upgrades for devices still under warranty that require any installation inside the device must be performed by a Welch Allyn service center unless you participate in the Partners in Care Biomed Partnership Program. If you want to install internal options, we recommend you attend either the classroom or online technical training course for the device. The training is required to be eligible to receive the Welch Allyn Service Tool Gold licensed edition. The Gold licensed edition is required to verify that the device is functioning correctly after it has been serviced. Although all of the option upgrades are calibrated and tested before leaving the factory, Welch Allyn recommends performing a complete functional test whenever the device is serviced.

Software upgrades, when available, can be purchased or provided at no charge if your device is covered by a Welch Allyn Service Agreement. The upgrades can be installed by either a Welch Allyn service center or by using the service tool, Standard unlicensed edition or Gold licensed edition.

If you choose to install software upgrades on your own, you will receive the software through the internet. When ordering software, provide the serial number of the device you want to install the software on.

Licenses are available for purchase to turn on additional software features or communication options. If you want to install licenses, you will need the service tool, Standard unlicensed edition or Gold licensed edition, and an internet connection. If you purchase a license, you will receive a code to enter in the service tool running on a PC connected to the internet that will contact a server and download the license file. The service tool connects with the device to install the license to turn on the advanced feature. A more detailed description of the license process can be found in the service tool help files.



NOTE When a license authorization code is used to activate the license, the authorization code is tied to the device's serial number. Save the license authorization code with the serial number for future use. If the main board is replaced, you will need the authorization code to reactivate the license files.

Available options, upgrades, and licenses

The following options, upgrades, and licenses can be added to each model's base configuration.



CAUTION Before installing any option, disconnect the patient from the wall system and power down the device.

Options

Model	8400	8500
Masimo	<input type="radio"/>	<input type="radio"/>
Nellcor	<input type="radio"/>	<input type="radio"/>
SureTemp Plus	<input type="radio"/>	<input type="radio"/>
Braun ThermoScan PRO 4000 ^{1, 2}	X	X
Braun ThermoScan PRO 6000 ³	<input type="radio"/>	<input type="radio"/>
Masimo with SpHb enabled ^{4, 5}	<input type="radio"/>	<input type="radio"/>
ECG ^{6, 7, 8}	<input type="radio"/>	<input type="radio"/>
Radio	<input type="radio"/>	<input checked="" type="radio"/>

¹ Upgrades no longer available. Service replacement only.

² Requires host software version 1.50.01 or higher.

³ Requires host software version 2.30.00 or higher.

⁴ Requires host software version 1.70.03 or higher.

⁵ Requires applicable UI license.

⁶ Requires the Continuous Monitoring profile license.

⁷ Requires LTA license for arrhythmia analysis.

⁸ Requires host software version 2.30.01 or higher.

Standard with this model.

Available hardware/software upgrade for this model.

Licensed features

Model	8400	8500
Vitals communication	<input checked="" type="radio"/>	<input checked="" type="radio"/>

Model	8400	8500
Barcode scanner	●	●
Weight scale ¹	○	○
Total hemoglobin (Masimo SpHb) ²	○	○
ECG LTA ³	●	●
Profiles		
Spot Check	●	●
Office ⁴	●	●
Triage ⁵	X	X
Intervals Monitoring ⁶	●	●
Continuous Monitoring ⁷	●	●

¹ Requires host software version 1.70.00 or higher.

² Requires host software version 1.70.03 or higher.

³ Requires host software version 2.30.01 or higher.

⁴ Requires host software version 1.71.00 or 2.30.00 or higher.

⁵ Triage is not available in host software 2.30.00 and higher.

⁶ In host software versions 1.X, this profile was called Monitor.

⁷ Requires host software version 2.20.00 or higher.

● Standard with this model.

○ Available hardware/software upgrade for this model.

Check the Connex device software version

Verify that the firmware version supports an option using one of the two methods described in this section.

Check the firmware version on the device

1. If the device is not running, power it on.
2. Touch the **Settings** tab.
3. Touch the **Advanced** tab.
4. In the right pane, check the number under Software version to identify the version currently running on your device.

Check the firmware version using the Service Tool

1. Connect the Connex device to a PC running the Service Tool with a type A to type B mini USB cable.
2. Launch the Welch Allyn Service Tool.
3. In the startup screen, click **Service**.
4. Either log in as ADMIN with no password or use any account you previously created.
5. Select the model of your device from the Device list tab.
The Device Information tab opens.
6. Locate the host controller in the Device Name column and follow the row across to the Available firmware column to identify the version currently running on your device.

Install options

Install internal options

All internal option installations entail opening the device case and performing some disassembly. Whenever you repair, replace, or install internal components, Welch Allyn requires that the device undergo a full functional test and electrical safety test before placing the device back in service.

Before installing an internal option, read the information about removing the option in "Disassembly and repair." After familiarizing yourself with the process, follow the instructions in the disassembly section to remove currently installed components or empty housings as needed, and then proceed to install new options.

Install external options

External options include ECG, Braun thermometers, barcode readers, and scales. Perform any required software upgrades and install any required licenses before connecting the option to the Connex device. Follow any instructions included with the option to set up or mount the option before connecting it to the Connex device.

1. Power down the Connex device and remove the A/C power cord.
2. Access the back panel of the Connex device
3. Locate the USB connector door.
4. Loosen the captive screw in the access door until you can open the door.
5. Plug the USB connector of the module external option (e.g., barcode reader) into any available USB port. Check that the connector is fully inserted.
6. Align the external option's USB cable with the corresponding slot in the USB access door and close the door.
7. Tighten the captive screw to secure the access door.
8. Connect the A/C power cord to the device.
9. Power on the device.
10. After the device boots up, follow the instructions in the device and/or option's *Instructions for use* to configure the option as necessary.

Upgrade software

If the current software version does not meet the minimum required version, update the Connex device firmware to the latest version that supports the option. To update the software, you will need the latest version of the Welch Allyn Service Tool, available from <https://www.hillrom.com/en/services/welch-allyn-service-tool/>. If necessary, follow the instructions in the Welch Allyn Service Tool Installation and Configuration Guide, available from <https://www.hillrom.com/en/services/welch-allyn-service-tool/>. Contact Hillrom Technical Support: [hillrom.com/en-us/about-us/locations/](https://www.hillrom.com/en-us/about-us/locations/) to obtain the latest version of Connex device software. Follow these steps to update the Connex device firmware using the Welch Allyn Service Tool:

1. Connect the Connex device to a PC running the Service Tool with a type A to type B mini USB cable.
2. Connect the AC power plug to an AC power outlet and power on the Connex device.
3. Launch the Welch Allyn Service Tool.
4. If the startup screen with the “Add new features” and “Service” button appears, click **Service**.
5. Either log in as ADMIN with no password or use any account previously created.
6. Select your Connex device from the Device list tab.
The Device Information tab opens.
7. Click the **Upgrade** tab.
8. Locate the host controller in the device column and follow the row across to the Available firmware column.
 - If a version number is present, click to select it.
 - If no upgrade available is shown, click **Check for upgrades**.
 - If no upgrade appears, contact Hillrom Technical Support: [hillrom.com/en-us/about-us/locations/](https://www.hillrom.com/en-us/about-us/locations/).
9. Click **View release notes** for information about this version.
10. Click **Upgrade all**.
11. In the dialog that appears asking if you want to continue, click **Yes** to continue or **No** to return to the Upgrade tab.



NOTE Once the upgrade starts, do not shut down or disconnect the device until the process is complete. The device will reboot and begin the upgrade process. The host controller software and any subsystem firmware will be upgraded with available firmware versions. The device will reboot multiple times depending on the number of subsystems requiring an update. For each subsystem, the progress spinner will progress from 0 to 100 percent.

When the upgrade is complete, the device returns to the Upgrade tab, and the Available firmware column will show NA for the host controller.

If the Chinese fonts and IME tables appear in the list of items to add to the device, you must install them to print charts as follows:

1. Complete steps 1 through 6 at the beginning of this topic.
2. Select Chinese fonts and IME tables from the list of items to add to the device.
3. Click **Add selected**.
4. In the dialog that asks if you want to continue, click **Yes** to continue or **No** to return to the Upgrade tab.

When the installation is complete, the device returns to the Upgrade tab.

Activate licenses

Licensed features are enabled using the licensing application in the Welch Allyn Service Tool. When you purchase a licensed upgrade for the Connex device, you receive an authorization code from Welch Allyn Customer Service. This code enables you to activate the new features through Service Tool's Install License feature.

1. Connect the Connex device to a PC running the Service Tool with a type A to type B mini USB cable.
2. Launch the Welch Allyn Service Tool.
3. If the startup screen with the "Add new features" and "Service" buttons appears, click **Add new features**.
4. Either log in as ADMIN with no password or use any account previously created.
5. Click on the **Administration** menu and select **Install license**.
6. Select **Medical device license** for the type of license you want to activate.
7. Enter your authorization code.
8. Select the device from the Device list.



NOTE The device must either be connected or on the maintained device list to appear.

9. Click **Activate**.



NOTE If the license you are activating is for a connected device, the license is installed immediately. If the license is for an offline (maintained) device, the license will be installed the next time the device is connected to the Service Tool. A new license activation action will be added to your work list.

10. After installing the license, power down and restart the Connex device to load the license and activate the new licensed features.



NOTE If a forced shutdown occurred immediately after installing the license, you might need to reinstall the license.

11. If you observe any issues or errors in the activation process, confirm that you entered the correct authorization code, check your Internet connection, and repeat the installation process. Confirm with your systems administrator that ports 5093 and 5094 on your firewall are open for TCP/IP communications. If you cannot resolve the issue, contact Hillrom Technical Support: hillrom.com/en-us/about-us/locations/.



NOTE Masimo SpHb requires an additional license that is installed as a software upgrade using the Service Tool. Additional instructions for installing the Masimo licenses are included with the Masimo parameter upgrade kits.

Host firmware requirements

This section lists the host firmware requirements for each parameter. If your device does not meet the minimum requirements, you can upgrade the host firmware with the Welch Allyn Service Tool.

- SpHb requirement: host firmware version 1.70.03 or later
- Braun ThermoScan PRO 6000 requirement: host firmware version 2.30.00 or later

- ECG requirement: host firmware version 2.30.01 or later

Masimo parameter upgrades

A Hemoglobin parameter upgrade is available for models 8400 and 8500 with Masimo SpO2.

Upgrading devices configured without Masimo SpO2

You can upgrade devices configured without Masimo SpO2 by adding Masimo SpO2 or by replacing the Nellcor SpO2 module with a Masimo SpO2 module.

If you participate in a SmartCare™ Biomed program, you can purchase an upgrade kit and complete the installation on your own. Upgrade kits contain a Masimo module with the desired parameters, a user interface license authorization code, and instructions for installing and licensing the upgrade. To complete the installation, you also need the tools listed in the “Disassembly and repair” section of this manual.

If you do not participate in a SmartCare™ Biomed program, contact Welch Allyn to order a Masimo hardware upgrade and arrange for Welch Allyn to perform the upgrade. Customers performing hardware upgrades without participating in a SmartCare™ Biomed program void the device warranty.

Upgrading devices configured with Masimo SpO2

If your device has a Masimo SpO2 module, you can enable new parameters by upgrading the module firmware. All customers can perform firmware upgrades on their own by using the service tool. To upgrade your module, purchase a firmware upgrade kit and follow the instructions provided with the kit.

Each parameter firmware upgrade is custom-built for a specific device and cannot be transferred to another device.

Configure options

When connected and powered on, the monitor recognizes all options. When the option successfully passes the POST, all software controls in the monitor’s user interface are activated, enabling you to configure option settings.

Option parameters are initially set at factory default values. To change these settings go to Advanced Settings. The configuration screens for SpO2, SpHb, Pulse rate, NIBP, Temperature, and Manual parameters are on the Parameters tab. The configuration screens for the radio are on the Network tab. For more information about the Advanced Settings menu, see the device’s *Instructions for use*.

Chinese fonts and input method editor (IME) tables

Chinese fonts

Chinese fonts require a lot of memory because each font size includes thousands of Chinese characters. The fonts are loaded separately to the Connex device to reduce the size of the binary

image (the *.pim file). The fonts are stored to non-volatile memory to preserve them through power cycles and software upgrades.

Chinese IME

IME is a component of the device software that allows users to input text in Chinese using a standard keyboard. The software translates multiple keystrokes to characters that otherwise could not be represented individually on keyboards.

IME technology relieves end users of the need to remember all possible ideographic character values. Instead, the IME monitors user keystrokes as they type Chinese character sounds in phonetic English and anticipates the Chinese characters the user might want. When several similar choices are available, the IME presents a list of candidate characters, giving the user an opportunity to choose the appropriate one.

Load Chinese font and IME tables

1. Open the WAST on your PC.
2. Connect a mini-USB cable to the PC and the Connex device.
3. On the Device list tab, click on the device name to select it and then click **Select**.
A new detailed device tab appears with the Device Information subtab selected.
4. Click on the **Upgrade** subtab.
The Upgrade subtab appears with two panes of upgrade options.
5. In the pane on the right, click **Chinese Fonts and IME Tables**, and then click **Add selected**.
A dialog appears asking if you want to continue the upgrade process.
6. Click **Yes** and wait for firmware update to complete.
A dialog presenting an instruction to wait appears and remains onscreen until the installation is complete. Then the dialog closes and the pane on the right of the Upgrade subtab disappears (assuming no other items populated that pane initially).

Field replaceable units

This section of the manual addresses only field-replaceable service parts. Product accessories—including patient sensors, probes, cables, batteries, probe covers, and other consumable items—are listed separately in the accessories list in the user documentation or repair parts/kits can be purchased through Hillrom sales channels. You can also visit the [Hillrom Parts Store](#) online to purchase replacement parts and accessories for your Welch Allyn device.

Table for service kits

The following table provides an at-a-glance view of service kits.

Material	Material Description	IEC 60601 compatibility		
		2nd edition ¹ Serial numbers prior to 100043244817	3rd edition ² Serial numbers 100043244817 to 100072205218	4th edition ³ Serial numbers 100072205218 and above
103573	VSM 6000 LCD frame	X	X	X
104269	Serv Kit, Chassis	X	X	X
105362	Serv Kit, VSM 6000, Labels, Models 6700, 6800	X	X	X
106824	Serv Kit, CVSM LCD frame to chassis harness 3rd Ed		X	X
106825	Serv Kit, CVSM LCD display 3rd Ed		X	X
106826	Serv Kit, CIWS AC Power Harness 3rd Ed		X	X
106827	Serv Kit, CIWS LCD display 3rd Ed		X	X
106829	Serv Kit, CIWS Power Supply 3rd Ed		X	X

Material	Material Description	IEC 60601 compatibility		
		2nd edition ¹ Serial numbers prior to 100043244817	3rd edition ² Serial numbers 100043244817 to 100072205218	4th edition ³ Serial numbers 100072205218 and above
106831	Serv Kit, CVSM/CIWS USB cable separator 3rd Ed		X	X
106832	Serv Kit, CVSM/CIWS Ethernet cable 20" 3rd Ed		X	X
106839 ⁴	Serv Kit, CVSM/CIWS Mainboard MCE 3rd Ed		X	X
107123	Serv Kit, power supply ESD shield			X
107124 ⁵	Serv Kit, CVSM SpO2 module, Nellcor 4th Ed	X	X	X
107166	Serv Kit, PLFM Comms PCBA, Newmar		X	X
107168	Serv Kit, CIWS Newmar antenna		X	X
107170	Serv Kit, CIWS Newmar radio		X	X
107172	Serv Kit, CIWS Newmar radio upgrade (radio and comms board)		X	X
107231 ⁶	Serv Kit, CVSM main board MCE with inbound		X	X
107257	Serv Kit, CIWS Main Housing Asy 4th Ed	X	X	X
107259	Serv Kit, CIWS SureTemp module 4th Ed	X	X	X
107281	Serv Kit, CVSM MODPG module assembly 4th Ed	X	X	X
107282	Serv Kit, CVSM SpO2 module, Masimo 4th Ed	X	X	X
107284	Serv Kit, CIWS Masimo MX 4th Ed	X	X	X
107286	Serv Kit, CIWS Masimo SpHb module repair 4th Ed	X	X	X

Material	Material Description	IEC 60601 compatibility		
		2nd edition ¹ Serial numbers prior to 100043244817	3rd edition ² Serial numbers 100043244817 to 100072205218	4th edition ³ Serial numbers 100072205218 and above
107288	Upgrade Kit, Masimo module SpO2 and RRa 4th Ed	X	X	X
107289	Serv Kit, Masimo module SpO2 and RRa repair 4th Ed	X	X	X
103388 (SERVICE ONLY)	Serv Kit, SpO2 module, Nellcor	X	X	
108610	Serv Kit, NIBP pump assembly ROHS3	X	X	X
103550	PLFM Light bar board	X	X	X
103551	Serv Kit, PLFM display	X	X	X
103569	VSM 6000 Light bar harness	X	X	X
104027	Braun dock cradle ring	X	X	X
103557	VSM 6000 Temp access cover	X	X	X
104028	Braun dock base	X	X	X
103545	VSM 6000 Temp housing (Templess)	X	X	X
105948	Serv Kit, Braun PRO 6000 thermometer	X	X	X
106462	VSM 6000 LCD bezel for 9" display	X	X	X
106512	Serv Kit, ECG module USB cable	X	X	X
106473	Braun PRO 6000 dock	X	X	X
103353	Serv Kit, VSM 6000 LED Light bar	X	X	X
6000-CBL3A	Serv Kit, Patient cable 3L AHA	X	X	X
6000-CBL3I	Serv Kit, Patient cable 3L IEC	X	X	X

Material	Material Description	IEC 60601 compatibility		
		2nd edition ¹ Serial numbers prior to 100043244817	3rd edition ² Serial numbers 100043244817 to 100072205218	4th edition ³ Serial numbers 100072205218 and above
6000-CBL5A	Serv Kit, Patient cable 5L AHA	X	X	X
6000-CBL5I	Serv Kit, Patient cable 5L IEC	X	X	X
6000-ECG3A	Serv Kit, ECG module, USB, Patient cable 3L AHA	X	X	X
6000-ECG3I	Serv Kit, ECG module, USB, Patient cable 3L IEC	X	X	X
6000-ECG5A	Serv Kit, ECG module, USB, Patient cable 5L AHA	X	X	X
6000-ECG5I	Serv Kit, ECG module, USB, Patient cable 5L IEC	X	X	X
105294 (Required software version 2.42 auto enabled)	Office Profile license	X	X	X
105363 (Required software version 2.42 auto enabled)	Continuous Profile license	X	X	X
105364 (Required software version 2.42 auto enabled)	CVSM 6700/6800 Standard license	X	X	X
103910 (Required software version 2.42 auto enabled)	CVSM 6300 Standard license	X	X	X
103371 (Required software version)	Bar code reader license	X	X	X

Material	Material Description	IEC 60601 compatibility		
		2nd edition ¹ Serial numbers prior to 100043244817	3rd edition ² Serial numbers 100043244817 to 100072205218	4th edition ³ Serial numbers 100072205218 and above
	2.42 auto enabled)			
103372 (Required software version 2.42 auto enabled)	Spot profile Standard license	X	X	X
103373 (Required software version 2.42 auto enabled)	Triage profile Standard license	X	X	X
103911 (Required software version 2.42 auto enabled)	CVSM 6400/6500 Standard license	X	X	X
104560	Serv Kit, PLFM, Radio	X	X	

¹ CIWS hardware and software has been modified to comply with IEC 60601 3rd Edition. All CIWS software will be harmonized starting with host software version 2.30.01.

² CIWS hardware and software has been modified to comply with IEC 60601 3rd Edition. All CIWS software will be harmonized starting with host software version 2.30.01.

³ All IEC 60601-1-1-2 4th edition compliant devices must be maintained with 4th edition compliant materials. All CIWSs manufactured from serial number 100025445218 and later will be serviced as 4th edition complaint devices.

⁴ Requires 2.41.01 firmware or higher comms module to be replaced to 410389-04, Housing to 106835, LCD screen kit 106825, Printer kit (new cabling) {If the device had a printer} 411695-01 and Nellcor module 412896 when replacing mainboard from second edition device.

⁵ Needs Host Firmware 2.41.01 to work with newer mainboards.

⁶ Requires 2.41.01 firmware or higher comms module to be replaced to 410389-04, Housing to 106835, LCD screen kit 106825, Printer kit (new cabling) {If the device had a printer} 411695-01 and Nellcor module 412896 when replacing mainboard from second edition device.

Licenses

Material no.	Item	Notes
103371	Bar code reader	
103372	Spot profile	

Material no.	Item	Notes
105294	Office profile	Requires host software version 1.71.00 or 2.30.00 or higher.
105363	Continuous Monitoring profile	
105364	Standard license	CIWS 8400/8500
104197	Weight scale	

SmartCare services for maintenance and repair

SmartCare protection plans

Material no.	Item
S1-CIWS-PRO-1	CIWS SmartCare Protection 1YR
S1-CIWS-PRO-3	CIWS SmartCare Protection 3YR
S1-CIWS-PRO-PS	CIWS SmartCare Protection 3YR POS

SmartCare protection plus plans

Material no.	Item
S9-CIWS-PROPLUS-1	CIWS SmartCare Protection Plus 1YR
S9-CIWS-PROPLUS-3	CIWS SmartCare Protection Plus 3YR
S9-CIWS-PROPLUS-PS	CIWS SmartCare Protection Plus 3YR POS

SmartCare biomed plans

Material no.	Item
S2-CIWS	One-year Biomed Partnership Program
S2-CIWS-2	Two-year Biomed Partnership Program
S2-CIWS-5	Five-year Biomed Partnership Program

Other service plans

Material no.	Item
103371	Barcode license
Partnership Programs for Global Use	
S1-CIWS	One-year Comprehensive Partnership Program
S1-CIWS-2	Two-year Comprehensive Partnership Program
Technical Training	
CIWSSERREPW-TRN	Technical online training for BiomedS
CIWSSERREP-TRN	Technical onsite training for BiomedS
International Only	
PRV-001	Preventive SVC WA bench per unit
PRV-002	Preventive SVC planned onsite per unit
S4-CIWS	One-year Extended Warranty
S4-CIWS-2	Two-year Extended Warranty
S4-CIWS-5	Five-year Extended Warranty

Service and repair training



NOTE Required to be eligible to receive the service tool, Gold licensed edition.

Material no.	Item
VSM6000SERREP-TRN	VSM 6000 series repair training
VSM6000SERREPW-TRN	VSM 6000 series repair web training
VSM6000REPCW-TRN	VSM 6000 series repair recertification web training

Service tools

Material no.	Item	Qty
103396	Welch Allyn Service Tool Gold license key (VSM6000)	1
web download	Welch Allyn Service Tool	1

Appendix

Decontamination and cleaning requirements for returns

As a general safety precaution, the Connex device must undergo decontamination before being returned to Welch Allyn for service, repair, inspection, or disposal.



NOTE Contaminated items must not be returned without prior, written agreement.



NOTE Decontaminate the device according to your facility's procedures and local regulations.

Cleaning is an essential prerequisite for effective disinfection or decontamination.

Clean the wall system



WARNING Electric shock hazard. Before cleaning the device, disconnect the AC power cord from the power outlet and the device.



WARNING Electric shock hazard. DO NOT autoclave the device or accessories. The device and the accessories are not heat-resistant.



WARNING Electric shock hazard. Do not open the wall system or attempt repairs. Only perform routine cleaning and maintenance procedures specifically described in this manual. Inspection and servicing of internal parts shall only be performed by qualified service personnel.



WARNING Liquids can damage electronics inside the device. Prevent liquids from spilling on the device.

If liquids are spilled on the device:

1. Power down the device.
2. Disconnect the power plug.
3. Remove battery pack from the device.
4. Dry off excess liquid from the device.



NOTE If liquids possibly entered the device, remove the device from use until it has been properly dried, inspected, and tested by qualified service personnel.

5. Reinstall battery pack.
6. Power on the device and verify device functions normally before using it.



CAUTION Sterilizing the monitor could damage the device.



NOTE Disinfect according to your facility's protocols and standards or local regulations.



NOTE See separate instructions for cleaning accessories.

Prepare to clean the equipment



CAUTION Some cleaning agents are not appropriate for all components of the device. Use only approved cleaning agents. Using unapproved cleaning agents may cause damage to components.



CAUTION Do not use bleach solutions of any kind when cleaning metal electrical contacts. They will damage the device.



CAUTION When cleaning the device, avoid using cloths or solutions that include quaternary ammonium compounds (ammonium chlorides) or glutaraldehyde-based disinfectants.

Select an approved cleaning agent from the following tables.

Section 1. Approved for the Connex Integrated Wall System *except the Braun ThermoScan PRO dock*

Cleaning agent	Additional information
10 percent bleach solution	(.5% - 1% sodium hypochlorite) applied to a clean cloth
70 percent isopropyl alcohol solution	Applied to a clean cloth

Section 2. Approved for the Braun ThermoScan PRO dock

Cleaning agent	Additional information
Clorox HP	
70 percent isopropyl alcohol solution	Applied to a clean cloth

Clean the accessories

1. Wipe the NIBP hose and any reusable cuffs with a damp cloth moistened in a mild detergent solution.
2. Wipe the temperature probe with a cloth dampened with alcohol, warm water, or an appropriately diluted, nonstaining disinfectant solution.
3. Clean the pulse oximetry sensors with a cloth dampened with 70 percent isopropyl alcohol or 10 percent chlorine bleach solution.

4. To clean the ECG module, follow the instructions provided in the ECG module directions for use.
5. To clean Welch Allyn 3.5V instrument heads attached to the physical assessment handles, follow the instructions provided in their directions for use.



CAUTION Never immerse any monitor accessories.

Configuration options

The wall system is available in multiple configurations. Use the following to determine available configurations:

[Model number][SpO2][Thermistor temp][Cord management][IR temp][Head pair]-[Power cord]



NOTE For approved accessories, see the accessories list in the device's directions for use.



NOTE If options were added to the device after production, the product label will not match the current configuration.

Position	Description
[Model number]	Two numbers that indicate the model: <ul style="list-style-type: none"> • 84: The 8400 model. Does not include a radio. • 85: The 8500 model. Includes an internal 802.11 a/b/g radio.
[SpO2]	One character that indicates the oximeter type: <ul style="list-style-type: none"> • H: Includes Masimo with Hemoglobin • M: Includes Masimo. • N: Includes Nellcor. • X: Does not include oximetry (8400 model only).
[Thermistor temp]	One character that indicates whether a SureTemp Plus thermometer is included: <ul style="list-style-type: none"> • T: Includes SureTemp Plus thermometer. • X: Does not include SureTemp Plus thermometer.
[Cord management]	One character that indicates the storage type: <ul style="list-style-type: none"> • V: SCS
[IR temp]	One character that indicates whether a Braun ThermoScan PRO thermometer and docking station are included: <ul style="list-style-type: none"> • E: Includes a Braun ThermoScan PRO and docking station. • X: Does not include a Braun ThermoScan PRO and docking station.
[Head pair]	One character that indicates whether 3.5V instrument heads are included: <ul style="list-style-type: none"> • C: Includes MacroView (23820) and Coaxial Ophthalmoscope (11720) heads. • P: Includes MacroView (23820) and PanOptic (11810) heads. • X: Does not include instrument heads.

Position	Description														
[Power cord]	The suffix, characters or numbers that follow the hyphen, indicates the power cord packaged with the device. Country codes include the following:														
	<table border="1"> <thead> <tr> <th>Suffix</th> <th>Description</th> </tr> </thead> <tbody> <tr> <td>B</td> <td>North America</td> </tr> <tr> <td>2</td> <td>Europe</td> </tr> <tr> <td>4</td> <td>United Kingdom</td> </tr> <tr> <td>6</td> <td>Australia/New Zealand</td> </tr> <tr> <td>7</td> <td>South Africa</td> </tr> <tr> <td>Z</td> <td>Brazil</td> </tr> </tbody> </table>	Suffix	Description	B	North America	2	Europe	4	United Kingdom	6	Australia/New Zealand	7	South Africa	Z	Brazil
Suffix	Description														
B	North America														
2	Europe														
4	United Kingdom														
6	Australia/New Zealand														
7	South Africa														
Z	Brazil														

Factory defaults

General alarm

Settings	Default value
General	
Display alarm limits	Enabled
Alarm audio on	Enabled
Alarm audio off	Disabled
Volume	Medium
Patient rest mode on	Off
Advanced	
General	
Allow user to disable alarms	Enabled
Nurse call threshold	Medium
Audio	
Allow user to turn off general audio	Enabled
Minimum alarm volume	Low
Audio pause time	2 minutes
Allow user to enable patient rest mode	Enabled
Allow host to enable patient rest mode	Enabled

Settings	Default value
Delays	
SpO2 alarm condition delay	10 seconds
SpO2 pulse rate alarm condition delay	3 seconds
Respiration alarm condition delay	10 seconds
No breath detected alarm delay	Adult: 30 seconds Pediatric: 20 seconds Neonate: 15 seconds
SpHb alarm condition delay	10 seconds

NIBP

Settings	Default value
Alarms	
Systolic and diastolic alarm limits on/off control	On
Systolic: Upper limit	Adult: 220 mmHg (29.3 kPa) Pediatric: 145 mmHg (19.3 kPa) Neonate: 100 mmHg (13.3 kPa)
Systolic: Lower limit	Adult: 75 mmHg (10.0 kPa) Pediatric: 75 mmHg (10.0 kPa) Neonate: 50 mmHg (6.7 kPa)
Diastolic: Upper limit	Adult: 110 mmHg (14.7 kPa) Pediatric: 100 mmHg (13.3 kPa) Neonate: 70 mmHg (9.3 kPa)
Diastolic: Lower limit	Adult: 35 mmHg (4.7 kPa) Pediatric: 35 mmHg (4.7 kPa) Neonate: 30 mmHg (4.0 kPa)
MAP alarm limits on/off control	Off
MAP: Upper limit	Adult: 120 mmHg (16 kPa) Pediatric: 110 mmHg (14.7 kPa)

Settings	Default value
	Neonate: 80 mmHg (10.7 kPa)
MAP: Lower limit	Adult: 50 mmHg (6.7 kPa) Pediatric: 50 mmHg (6.7 kPa) Neonate: 35 mmHg (4.7 kPa)
Intervals	
Interval	Automatic
Minutes	15 minutes
Automatic print on interval	Disabled
Advanced	
Display MAP	Enabled
SYS/DIA as primary	Enabled
MAP as primary	Disabled
Tube type	2 tubes
Unit of measure	mmHg
Algorithm default	SureBP
Cuff inflation target (step algorithm)	
Adult	160 mmHg (21.3 kPa)
Pediatric	140 mmHg (18.7 kPa)
Neonate	90 mmHg (12.0 kPa)
Allow interval program changes	Enabled
Programs (NIBP Averaging)	Programs 1 to 6 (default settings are empty)

SpO₂

Settings	Default value
Alarms	
Alarm limits on/off control	On
Upper limit	Adult: 100%

Settings	Default value
	Pediatric: 100% Neonate: 100%
Lower limit	Adult: 90% Pediatric: 90% Neonate: 90%
SatSeconds™ (Nellcor only)	0
Advanced	
Default view	% SpO2
Default response	Normal
Sweep speed default	25 mm/s
Allow low perfusion alarm	Enabled

SpHb

Settings	Default value
Alarms	
Alarm limits on/off control	On
Upper limit	17.0 g/dL (11.0 mmol/L)
Lower limit	7.0 g/dL (4.0 mmol/L)
Setup	
Trend period	1 hr
Advanced	
Default view	Numeric
Reference	Venous
Unit of measure	g/dL
Default averaging	Medium

Temperature

Settings	Default value
Alarms	
Alarm limits on/off control	Off
Upper limit	101 °F (38.3 °C)
Lower limit	94 °F (34.4 °C)
Advanced	
Unit of measure	°F (Fahrenheit)
Display temperature conversion	Enabled
Default SureTemp Plus site	Oral
Braun 6000	
Anti-theft return time out	Disabled
Mode	Technique compensation
Enable pulse timer	Enabled
Enable Celsius only selection	Disabled

Pulse rate

Settings	Default value
Alarms	
Alarm limits on/off control	On
Upper limit	Adult: 120 bpm Pediatric: 150 bpm Neonate: 200 bpm
Lower limit	Adult: 50 bpm Pediatric: 50 bpm Neonate: 100 bpm
Setup	
Tone volume	Off
Advanced	

Settings	Default value
Display source	Enabled

RR

Settings	Default value
Alarms	
Alarm limits on/off control	On
Upper limit (ECG)	Adult: 30 breaths per minute Pediatric: 40 breaths per minute
Lower limit (ECG)	Adult: 5 breaths per minute Pediatric: 10 breaths per minute
No breath alarm	Adult: 30 seconds Pediatric: 20 seconds Neo: 15 seconds

ECG

Settings	Default value
Alarms	
Alarm limits on/off control	On
Upper limit	120
Lower limit	50
Setup	
ECG gain	10mm/mV
Sweep speed	25 mm/s
Filter	Enabled
Pacemaker detection	Disabled
Use ECG as an RR source when available	Disabled
Advanced	

Settings	Default value
Enable cardiac high priority tone	Enabled
Cable selection	3 lead
Electrode configuration	AHA
Allow impedance respiration	Enabled
V-Tach, V-Fib, Asystole detection enable	Enabled
Automatic print on ECG alarm	Enabled
Default lead	II
V-Tach threshold	120

Custom scores

Settings	Default value
Advanced	
Default score summary view	Condensed
Incomplete score save options	Allow

Patient manual parameters



NOTE Defaults appear in software versions lower than 2.30.00 when you open the keypad or use the up/down arrow keys for entry. In software versions 2.30.00 and higher, the manual parameter fields are blank (no defaults set).

Settings	Default value
Height	70 in (177.8 cm)
Weight	150 lb (68.0 kg)
Pain	0
Respiration	12
Temperature	98.6 °F (37 °C)
Advanced¹	
Display height	Enabled

Settings	Default value
Display weight	Enabled
Display pain	Enabled
Display respiration	Enabled
Display temperature ²	Disabled
Display BMI	Disabled
Height units	in
Weight units	lb
Enable manual override NIBP Default value	Enabled
Enable manual override Pulse rate	Enabled
Enable manual override Temperature Default	Enabled
Enable manual override RR Default	Enabled
Enable manual override SpO2 Default	Enabled

¹ You can enable only four manual parameters.

² If a temperature module is available, manual temperature selection is not available.

Patient manual parameters



NOTE In software versions 2.30.00 and higher, the manual parameter fields are blank (no defaults set).

Settings	Default value
Height	
Weight	
Pain	
Respiration	
Temperature	
Advanced¹	
Display height	Enabled
Display weight	Enabled

Settings	Default value
Display pain	Enabled
Display respiration	Enabled
Display temperature ²	Disabled
Display BMI	Disabled
Height units	in
Weight units	lb
Enable manual override NIBP Default value	Enabled
Enable manual override Pulse rate	Enabled
Enable manual override Temperature Default	Enabled
Enable manual override RR Default	Enabled
Enable manual override SpO2 Default	Enabled

¹ You can enable only four manual parameters.

² If a temperature module is available, manual temperature selection is not available.

Device

Settings	Default value
Temporarily pause patient monitoring ¹	10 minutes
Display brightness	6
Allow display lock timeout	Enabled
Profiles	Spot Check
Advanced	
Language	English
Date/time	
Date format	mm/dd/yyyy
Time zone	UTC
Automatically adjust clock for daylight saving time, reported by host	Disabled
Allow users to change date and time	Enabled

Settings	Default value
Display date and time	Enabled
Display	
Display lock	Never
Display power saver	2 minutes
Device power down	20 minutes
Device	
Enable save as default	Enabled
Standby Mode timeout	10 minutes
Allow profile change	Enabled
Power line frequency	60 Hz
Demo	
Type	Normal values
†Continuous mode only	

Data management

Settings	Default value
Advanced	
Patient	
Default patient type	Adult
Name format	Full name
Primary label	Name
Secondary label	Patient ID
Printout label	Name and patient ID
Require patient ID to save readings	Disabled
Search by patient ID	Disabled
Clear patient information on manual save	Enabled
Retrieve list	Disabled

Settings	Default value
Clinician	
Label	Clinician ID
Require clinician ID to save readings	Disabled
Search by clinician ID	Disabled
Require password	Disabled
Clear clinician information on manual save	Disabled
Clinical data	
Automatically send on manual save	Disabled
Delete readings after successful send	Disabled
Emulate Spot Vital Signs LXi	Enabled
Connect to Connex CS	Enabled

Network



NOTE Unless otherwise noted, the numbers in parentheses presented in the Options column indicate the maximum number of alphanumeric characters you can enter in the field for that setting.

Radio (Newmar)

Settings	Comments	Options / Data type / Length	Default value
Radio	n/a	Enabled, Disabled	Enabled
Radio alarms	n/a	Enabled, Disabled	Disabled
Radio ESSID selection	n/a	(32)	com.welchallyn
Radio band	n/a	a, a/n, a/b/g, a/b/g/n, b/g/n	a/b/g/n
Dynamic frequency selection	n/a	Enabled, Disabled	Enabled
Authentication/ Encryption	n/a	Open, WPA-Personal, WPA-Enterprise, WPA2-Personal, WPA2-Enterprise, WEP 64, WEP 128	WPA2-Personal

Radio (Newmar)

Settings	Comments	Options / Data type / Length	Default value
Pre-shared key method type	Only available when WPA-Personal or WPA2-Personal is selected.	Network Key, Passphrase	Network Key
Method	<p>Only available when WPA-Personal or WPA2-Personal is selected.</p> <p>If Pre-Shared Key Method Type is Passphrase, UI must only allow 8-63 ASCII characters.</p> <p>If Pre-Shared Key Method Type is Network Key, UI must require exactly 64 hexadecimal characters.</p>	(64)	1234567890ABCDEF 1234567890ABCDEF 1234567890ABCDEF 1234567890ABCDEF
EAP type	Only available when WPA-Enterprise or WPA2-Enterprise is selected.	TLS, TTLS, PEAP-MSCHAPv2, PEAP-GTC, PEAP-TLS, EAP-FAST	PEAP-MSCHAPv2
EAP identity	Only available when WPA-Enterprise or WPA2-Enterprise is selected.	(32)	vitalsigns
EAP password	Only available when WPA-Enterprise or WPA2-Enterprise is selected and EAP type is NOT TLS or PEAP-TLS.	Up to 32 printable ASCII characters, U+0020 to U+007E	password
Roam type	Only available when WPA-Enterprise or WPA2-Enterprise is selected.	PMK Caching, OKC, CCKM	OKC
Server validation	Only available when WPA-Enterprise or WPA2-Enterprise is selected and EAP type is NOT EAP-FAST.	Enabled, Disabled	Disabled
Allow anonymous identity	Only available when WPA-Enterprise or WPA2-Enterprise is selected and EAP type is NOT TLS or TTLS.	Enabled, Disabled	Disabled
PAC provisioning field	Only available when WPA-Enterprise or WPA2-Enterprise is selected and EAP type is EAP-FAST.	Auto, Manual	Auto
Inner EAP setting	Only available when WPA-Enterprise or WPA2-Enterprise is selected and EAP type is EAP-FAST.	Auto, PAP	Auto
WEP 64 Key number	<p>Only available when WEP 64 is selected.</p> <p>0-3 range within object presented as 1-4 on UI.</p>	1, 2, 3, 4	1
WEP 64 Key 1	<p>Only available when WEP 64 is selected.</p> <p>WEP 64 requires 10 hexadecimal chars (0-9, A-F).</p>	(10)	0123456789

Radio (Newmar)

Settings	Comments	Options / Data type / Length	Default value
WEP 64 Key 2	Only available when WEP 64 is selected. WEP 64 requires 10 hexadecimal chars (0-9, A-F).	(10)	0123456789
WEP 64 Key 3	Only available when WEP 64 is selected. WEP 64 requires 10 hexadecimal chars (0-9, A-F).	(10)	0123456789
WEP 64 Key 4	Only available when WEP 64 is selected. WEP 64 requires 10 hexadecimal chars (0-9, A-F).	(10)	0123456789
WEP 128 Key number	Only available when WEP 128 is selected. 0-3 range within object presented as 1-4 on UI.	1, 2, 3, 4	1
WEP 128 Key 1	Only available when WEP 128 is selected. WEP 128 requires 26 hexadecimal chars (0-9, A-F).	(26)	0123456789ABCDEF 0123456789
WEP 128 Key 2	Only available when WEP 128 is selected. WEP 128 requires 26 hexadecimal chars (0-9, A-F).	(26)	0123456789ABCDEF 0123456789
WEP 128 Key 3	Only available when WEP 128 is selected. WEP 128 requires 26 hexadecimal chars (0-9, A-F).	(26)	0123456789ABCDEF 0123456789
WEP 128 Key 4	Only available when WEP 128 is selected. WEP 128 requires 26 hexadecimal chars (0-9, A-F).	(26)	0123456789ABCDEF 0123456789
FIPS mode	Only available when (WPA2-Personal) or (WPA2-Enterprise and TLS EAP type and Roam Type != CCKM) is selected.	Enabled, Disabled	Enabled

Radio (Lamarr)

Settings	Comments	Options / Data type / Length	Default value
Radio	n/a	Enabled, Disabled	Enabled
Radio alarms	n/a	Enabled, Disabled	Disabled
Radio ESSID selection	This setting can be controlled through the UI only when the value is part of the list and will take effect on a reboot.	(32)	com.welchallyn
Radio band	n/a	a, b/g	b/g
Authentication/ Encryption	n/a	Open, WPA2-PSK, WPA2-AES, WEP 64, WEP 128	WPA2-PSK
Pre-shared key method type	Only available when WPA2-PSK is selected.	Network Key, Passphrase	Network Key
Method	Only available when WPA2-PSK is selected. If Pre-Shared Key Method Type is Passphrase, UI must only allow 8-63 ASCII characters. If Pre-Shared Key Method Type is Network Key, UI must require exactly 64 hexadecimal characters.	(64)	1234567890ABCDEF 1234567890ABCDEF 1234567890ABCDEF 1234567890ABCDEF
Security protocol	Only available when WPA2-PSK or WPA2-AES is selected.	CCMP, CCMP, and TKIP	CCMP
EAP type	Only available when WPA2-AES is selected.	TLS, TTLS, PEAP, Auto (TLS, TTLS, or PEAP)	TLS
EAP identity	Only available when WPA2-AES is selected.	(32)	vitalsigns
EAP password	Only available when WPA2-AES is selected.	Up to 32 printable ASCII characters, U+0020 to U+007E	password
WEP 64 Key number	Only available when WEP 64 is selected. 0-3 range within object presented as 1-4 on UI.	1, 2, 3, 4	1
WEP 64 Key 1	Only available when WEP 64 is selected. WEP 64 requires 10 hexadecimal chars (0-9, A-F).	(10)	0123456789
WEP 64 Key 2	Only available when WEP 64 is selected.	(10)	0123456789

Radio (Lamarr)

Settings	Comments	Options / Data type / Length	Default value
	WEP 64 requires 10 hexadecimal chars (0-9, A-F).		
WEP 64 Key 3	Only available when WEP 64 is selected. WEP 64 requires 10 hexadecimal chars (0-9, A-F).	(10)	0123456789
WEP 64 Key 4	Only available when WEP 64 is selected. WEP 64 requires 10 hexadecimal chars (0-9, A-F).	(10)	0123456789
WEP 128 Key number	Only available when WEP 128 is selected. 0-3 range within object presented as 1-4 on UI.	1, 2, 3, 4	1
WEP 128 Key 1	Only available when WEP 128 is selected. WEP 128 requires 26 hexadecimal chars (0-9, A-F).	(26)	0123456789ABCDEF 0123456789
WEP 128 Key 2	Only available when WEP 128 is selected. WEP 128 requires 26 hexadecimal chars (0-9, A-F).	(26)	0123456789ABCDEF 0123456789
WEP 128 Key 3	Only available when WEP 128 is selected. WEP 128 requires 26 hexadecimal chars (0-9, A-F).	(26)	0123456789ABCDEF 0123456789
WEP 128 Key 4	Only available when WEP 128 is selected. WEP 128 requires 26 hexadecimal chars (0-9, A-F).	(26)	0123456789ABCDEF 0123456789

Server

Settings	Comments	Options / Data type / Length	Default value
Server determination type	n/a	Manual Entry, NRS IP, DNS, DHCP43	Lamarr: Manual Entry Newmar: DNS

Server

Settings	Comments	Options / Data type / Length	Default value
Network Rendezvous Server IP	Only used if Server Determination Type is NRS IP.	IP Address Array of 4 numbers, each byte's range is 0-255	0.0.0.0
Network Rendezvous Server port	Only used if Server Determination Type is Broadcast, NRS IP, DNS, or DHCP43.	Integer (0-65535)	7711
DNS hostname	Only used if Server Determination Type is DNS. Only enabled on the UI if radio version supports DNS.	(128)	WANRS
DHCP option 60 vendor string	Only used if Server Determination Type is DHCP43. Only enabled on the UI if radio version supports DHCP option 43. Currently visible but not configurable from the UI; only the default value is used.	(128)	welchallyn-nrs
Call home enable	Has no effect if call home is disabled by upgrade. Does not affect ability to manually initiate a call home session.	Enabled, Disabled	Enabled
Data encryption enable	n/a	Enabled, Disabled	Disabled
Server authentication enable	n/a	Enabled, Disabled	Disabled
Episodic WACP server address	Used when server determination type is Manual entry	(128)	hostname
Episodic WACP server port	Used when server determination type is Manual entry	Integer (0-65535)	281
Continuous WACP server address	Used when server determination type is Manual entry	(128)	hostname
Continuous WACP server port	Used when server determination type is Manual entry	Integer (0-65535)	291
Service WACP server address	Used when server determination type is Manual entry	(128)	hostname

Server			
Settings	Comments	Options / Data type / Length	Default value
Service WACP server port	Used when server determination type is Manual entry	Integer (0-65535)	283

Service

Settings	Default value
Advanced	
General	
PartnerConnect enable auto sync	Enabled
Enable external USB ports	Enabled

Password

Settings	Default value
Advanced	
Change password	6345
Enable failed attempt lockout	Disabled
Enable password expiration	Disabled
Password expiration	730 days

Disassembly and repair reference

Screws

Quantity	Location	Type	Size/length	Torque	Bit type
2	Comms connection cover	Pan head machine	M4x10	7.5 in-lb ± 0.5 in-lb	#2 Phillips
1	Module cover	Pan head machine	M4x10	7.5 in-lb ± 0.5 in-lb	#2 Phillips
2	Braun housing or end cap	Pan head machine	M4x10	7.5 in-lb ± 0.5 in-lb	#2 Phillips
4	Module retaining plate	Pan head machine	M4x10	7.5 in-lb ± 0.5 in-lb	#2 Phillips
10	Handle module assembly housing	Pan head machine	M4x10	7.5 in-lb ± 0.5 in-lb	#2 Phillips
3	767 controller PCBA	Plastite	#4-20 x 0.500	7.5 in-lb ± 0.5 in-lb	Torx T10
2	Top housing extension	8mm hex standoff	M4x0.7	12 in-lb ± 1.0 in-lb	8mm socket
6	Main housing	Pan head machine	M4x10	7.5 in-lb ± 0.5 in-lb	#2 Phillips
4	Power supply	Plastite	#4-20 x 0.500	7.5 in-lb ± 0.5 in-lb	Torx T10
4	Comms PCBA	Plastite	#4-20 x 0.500	7.5 in-lb ± 0.5 in-lb	Torx T10
4	Radio board (Lamarr)	Pan head machine	M3x0.5x8	6.0 in-lb ± 0.5 in-lb	#1 Phillips
3	Radio board (Newmar)	Pan head machine	M2x6	2.5 in-lb ± 0.25 in-lb	Small Phillips
2	Light bar cover	Plastite	#4-20 x 0.500	7.5 in-lb ± 0.5 in-lb	Torx T10
2	Power panel	Plastite	#4-20 x 0.500	7.5 in-lb ± 0.5 in-lb	Torx T10
2	Battery board	Plastite	#4-20 x 0.500	7.5 in-lb ± 0.5 in-lb	Torx T10
1	P-clamp, Ethernet cable	Pan head machine	M3x0.5x8	6.0 in-lb ± 0.5 in-lb	#1 Phillips
7	Main board	Pan head machine	M3x0.5x8	6.0 in-lb ± 0.5 in-lb	#1 Phillips
4	LCD frame	Pan head machine	M4x10	7.5 in-lb ± 0.5 in-lb	#2 Phillips
2	Module well	Plastite	#4-20 x 0.500	7.5 in-lb ± 0.5 in-lb	Torx T10
2	P-clamp, USB cable bundle	Pan head machine	M4x10	7.5 in-lb ± 0.5 in-lb	#2 Phillips
4	Module tracks	Plastite	#4-20 x 0.500	7.5 in-lb ± 0.5 in-lb	Torx T10
2	Blue insert	Plastite	#4-20 x 0.500	7.5 in-lb ± 0.5 in-lb	Torx T10

Quantity	Location	Type	Size/length	Torque	Bit type
2	USB client cable	Plastite	#4-20 x 0.500	7.5 in-lb ± 0.5 in-lb	Torx T10

Connectors

Connector types

Disassembly and repair procedures require that you disconnect and reconnect the following connector types:

- **Locking (squeeze-release):** Locking connectors use a latching mechanism to prevent accidental disconnection during assembly and use. The latch is located on one end of a tab so it may flex and lock into place when coupled with its matching connector. The tab provides a lever to release the latch. When disconnecting, squeeze to provide pressure on the tab to unlatch. Some connectors have multiple latches that require you to press multiple tabs to release.

To remove a locking connector, squeeze the release lever and remove the cable.

To connect a locking connector, push the mating pieces together until the latch locks in place.

- **Pressure:** Pressure connectors use friction to prevent accidental disconnects.

To remove a pressure connector, grasp each connector mating half and pull the halves apart.



CAUTION Do not use excessive force to disconnect the connector. Excessive force may result in pulling the mounted connector off the circuit board.

To connect a pressure connector, grasp each connector mating half and insert one half into the other.

- **USB:** USB connectors provide communications and power connectivity between the main board and any sub-systems and external devices. USB connectors use friction to maintain the connection, but rarely require much force to connect or disconnect. The USB cable can safely be removed from the mounted connector by simply pulling it out of the connector. Two types of USB connectors are used: USB A-type and USB mini-B.

To remove a USB connector, grasp the connector and pull.

To connect a USB connector, grasp the connector and insert.

- **ZIF (zero insertion force):** The device uses flex cables and ZIF flex cable connectors. Flex cables and ZIF connectors require special care when handling.

ZIF connectors use a sliding outer piece that latches and unlatches to secure and release the flex cable. ZIF cables cannot be successfully connected or disconnected without properly unlatching and latching the sliding outer piece.



CAUTION Do not use excessive force when releasing pressure on the connector. Excessive force may result in breaking the sliding outer piece.

To remove a ZIF connector



CAUTION Remove a flex cable only *after* the ZIF latch is open.

1. Using a suitable tool (for example, a paper clip, small flat-head screwdriver, or needle-nose pliers), slide the latching piece of the connector away from the connector body.

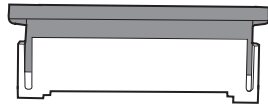

2. Remove the cable.

To connect a ZIF connector

1. Slide the latching piece of the connector away from the connector body.
2. Insert the flex cable into the connector. This may require using a suitable tool to keep the latching piece elevated.
3. Slide the latching piece toward the connector body until it locks into place.

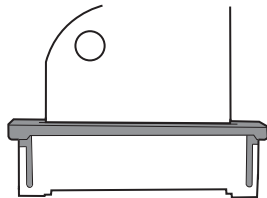

Connectors

Main board connectors

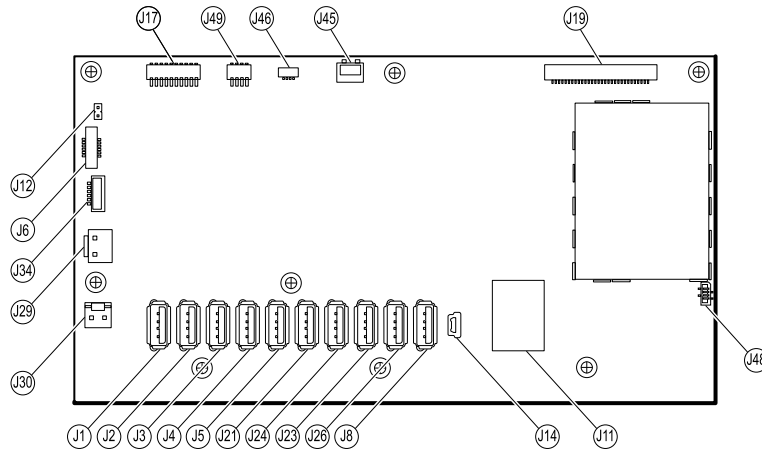

Connector	Wiring harness	Connects with	Connector
J1	USB	MCE to modules—Braun if required	USB
J2	USB	MCE to modules	USB
J3	USB	MCE to modules	USB
J4	USB	MCE to modules	USB
J5	USB	MCE to modules	USB

Connector	Wiring harness	Connects with	Connector
J6	Power button	Power button and LED status	ZIF
J8	USB	MCE to handle module PCBA	USB
J11	Ethernet	Communications board	Locking
J12	Main harness	Speaker	Pressure
J14	Client USB	Communications board J8	Mini USB
J17	Not used	Not used	Pressure
J19	LCD	LCD board	Pressure
J21	USB	MCE to SpO2	USB
J23	USB	Communications board J4	USB
J24	USB	MCE to NIBP	USB
J26	USB	Reserved for future use	USB
J29	Battery power	Battery connector board J2	Locking
J30	Main harness	Power supply board J2	Pressure
J34	Battery	Battery connector board J3	Locking
J45	Main harness	Fan connector on the power-supply cover	Locking
J46	Light bar	Light bar board J1	Pressure
J48	LCD flex cable	LCD	Pressure
J49	Main harness	Communications board power	Pressure

Battery connector board connectors

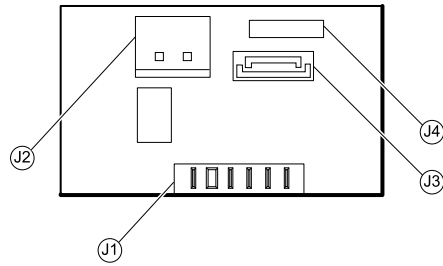

Connector	Wiring harness	Connects with	Connector
J1	N/A	Battery	Pressure
J2	Battery power	Main board J29	Locking
J3	Battery	Main board J34	Locking
J4	N/A	Internal use only	N/A

Communications board connectors

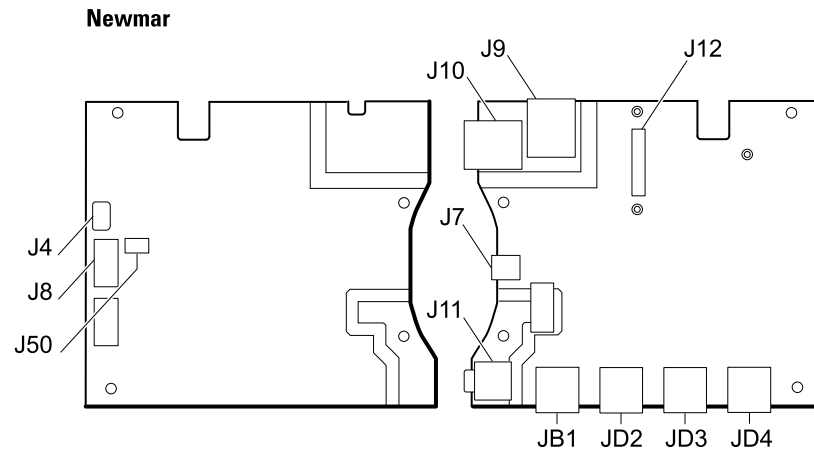
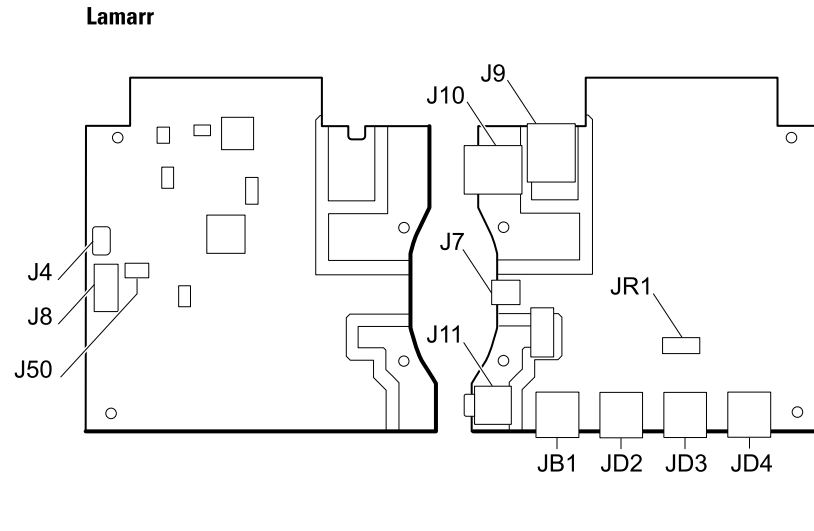

Connector	Wiring harness	Connects with	Connector
J4	USB	Main board J23	Mini USB
J7	USB	External (client)	Mini USB
J8	USB	Main board J14	USB
J9	Ethernet	Main board J11	Locking (RJ45)
J10	Ethernet	External	Locking (RJ45)
J11 *	Nurse call	External	Mini stereo
J12	N/A	Radio (Newmar)	Pressure

Connector	Wiring harness	Connects with	Connector
J50	Main	Main board J49	Pressure
JB1	USB	External	USB
JD2 *	USB	External	USB
JD3 *	USB	External	USB
JD4 *	USB	External	USB
JR1 *	N/A	Radio (Lamarr)	Pressure

* Not available on the Basic communications board.

Radio board connectors

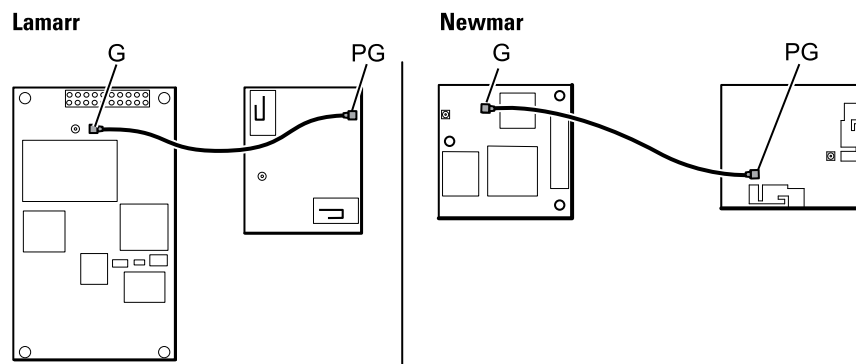

Connector	Wiring harness	Connects with	Connector
B	Not used	Not used	Pressure
G	Antenna cable	Antenna board PG	Pressure
A (not labeled)	N/A	Standard communications board JR1 (Lamarr) Standard communications board J12 (Newmar)	Pressure

Antenna board connectors

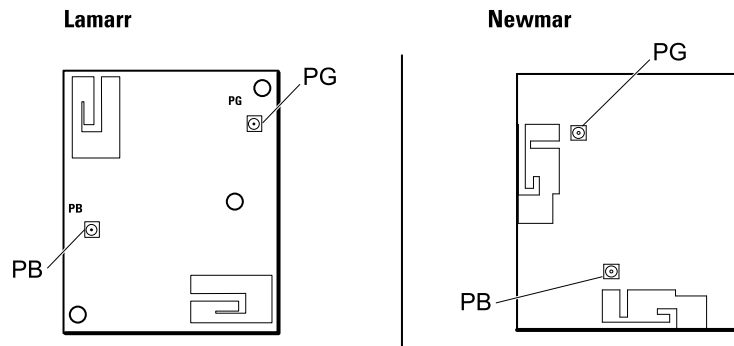

Connector	Wiring harness	Connects with	Connector
PG	Antenna cable	Radio board G	Pressure
PB	Not used	Not used	Pressure

767 controller board connectors

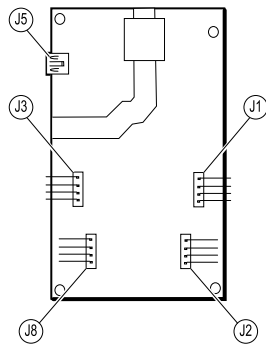

Connector	Wiring harness	Connects with	Connector
J1	Optical assembly	Handle cradle	Pressure
J2	Handle assembly	Handle	Pressure
J3	Optical assembly	Handle cradle	Pressure
J5	USB	Main board J8	USB (mini)
J8	Handle assembly	Handle	Pressure

Power supply board connectors

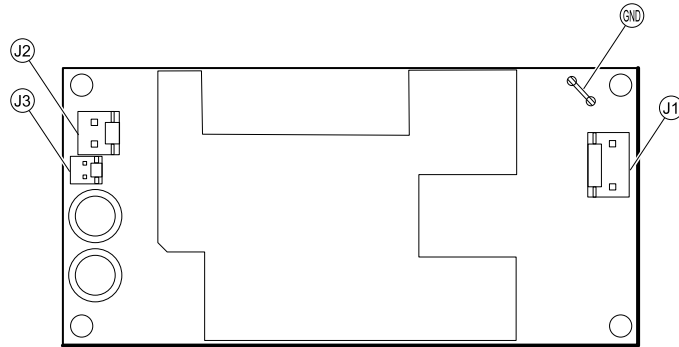

Connector	Wiring harness	Connects with	Connector
J1	AC to power supply	IEC connector (blue: neutral, brown: line in)	Pressure
J2	Main harness	Main board J30	Pressure
J3	N/A	Internal use only	N/A
GND	AC to power supply	IEC connector (green: ground) via ground stud	Pressure

Connex Integrated Wall System interconnect diagram

IEC 60601 2nd edition-compliant devices: 6-hole USB cable separator

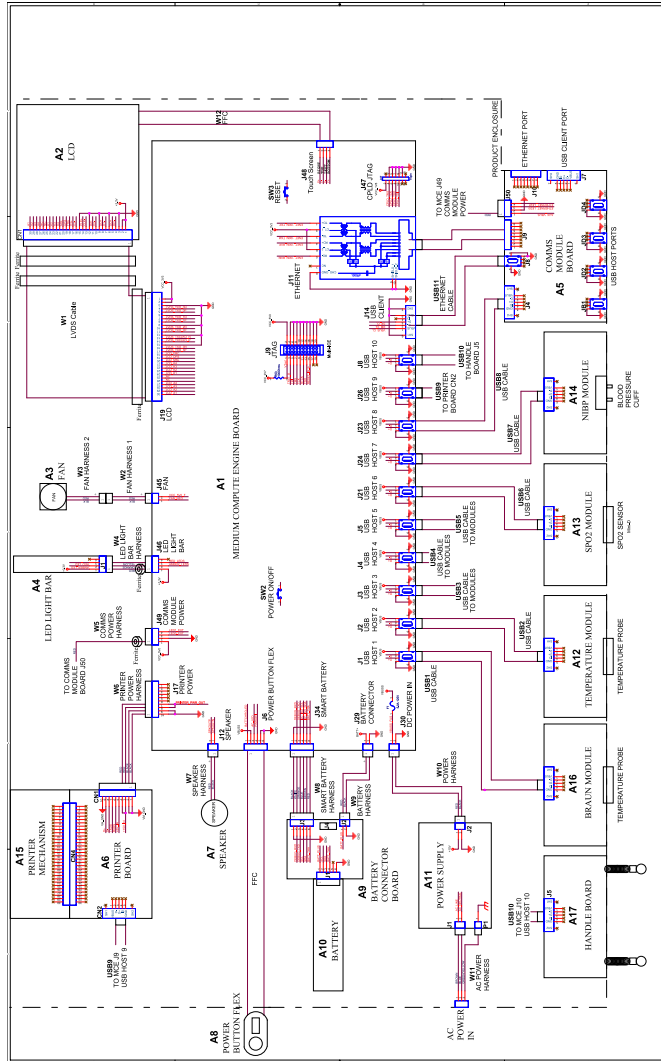

IEC 60601 3rd edition-compliant devices: 9-hole USB cable separator

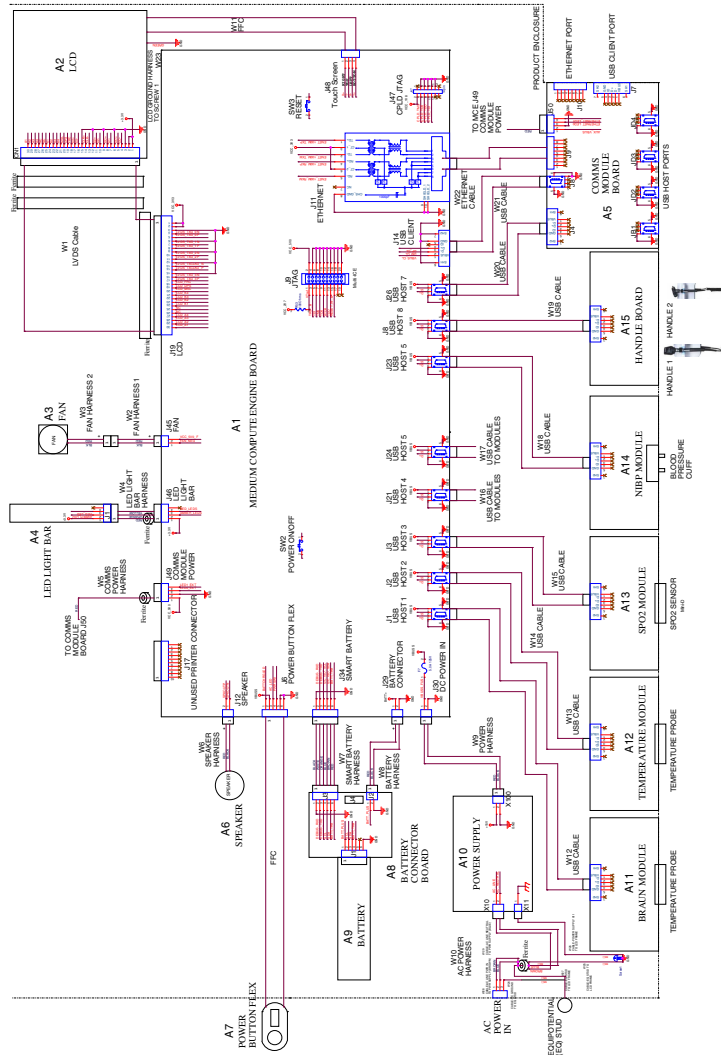

Service and maintenance toolset

Connex devices

The following is the listing of tools and test equipment required to perform basic functional verification checks, full functional verification checks and calibration, and service and maintenance on the Welch Allyn Connex devices (CVSM and CIWS).



NOTE Tools and test equipment must also be readily available to complete Welch Allyn Technical Service Training for this device.

Material no.	Description	Qty	Usage	
			Full	Basic
General test equipment				
106270	Service test box	1	X	
N/A	Wireless router, a/b/g or equivalent	1	X	
N/A	Ethernet cable	1	X	
660-0138-00	Cable, patch 5 feet RJ45, T568B	1	X	
407022	Assy, MMF Nurse call cable - service	1	X	
4500-925	USB 2.0/5-pin Mini-B cable, gold, 6 ft.	1	X	X
N/A	PC running Windows 10	1	X	X
web download	Welch Allyn Service Tool (version 1.8 or later)	1	X	X
103396	Welch Allyn Service Tool, Gold license	1	X	
NIBP testing				
407672	BP test volume repair fixture 113670	1	X	X
N/A	Pressure meter (must include at least one decimal point and be accurate to within ± 0.5 mmHg)	1	X	X
N/A	Blood pressure Y-tube	1	X	X
6000-30	Single tube blood pressure hose, 5 ft.	1	X	X
4500-30	Blood pressure hose, 5 ft.	1	X	
620216	Fitting "Y" 1/8 X 1/8 X 1/8	1	X	X
Nellcor SpO2 configuration testing				
N/A	SpO2 simulator	1	X	X

Material no.	Description	Qty	Usage	
			Full	Basic
DOC-10	Nellcor SpO2 extension cable	1	X	X
Masimo SpO2 configuration testing				
N/A	SpO2 simulator	1	X	X
SureTemp Plus configuration testing				
06138-000	Cal-key, assembly, M690/692	1	X	X
01802-110	Tester, calibration, 9600 Plus	3	X	
Braun ThermoScan PRO 4000 / PRO 6000 configuration testing				
01802-110	Tester, calibration, 9600 Plus	3	X	
Braun ThermoScan PRO 6000 configuration testing				
411690	Braun PRO 6000 calibration fixture	3	X	X

Notes:

- All items marked "N/A" in the Material no. column are OEM or off-the-shelf tools and equipment not available from Welch Allyn. The remaining items are available through Welch Allyn or a Welch Allyn distributor.
- All items marked in the Full column are required for full functional verification checks and calibration. The Welch Allyn Service Tool software and an active Gold license is also required to perform these checks. The Gold license is obtained upon successful completion of Welch Allyn Technical Service Training.
- All items marked in the Basic column are required for basic functional verification checks. The Welch Allyn Service Tool software Standard unlicensed edition can be used to perform the NIBP checks and software upgrades/updates.

Miscellaneous Tools

- #1 Phillips bit
- #2 Phillips bit
- #10 Torx bit
- 8mm socket
- Torque driver calibrated for 2.5 in-lb ± 0.25 inch-pound
- Torque driver calibrated for 6.0 in-lb ± 1.0 inch-pound
- Torque driver calibrated for 7.5 in-lb ± 0.5 inch-pound
- Torque driver calibrated for 12.0 inch-pound ± 1.0 inch-pound
- Slotted screwdriver
- Tweezers
- Needle-nose pliers
- Spudger

- Tie-wrap tool
- Tie-wrap cutter
- Soft lens wipes
- Scissors or other cutting device
- Canned air to remove dust and debris
- A coin to open the battery door; select a size that comfortably fits the slot
- Pro Gaff tape

Connex Direct

Introduction

Follow these steps to:

- set up an Active Directory connection for clinician authentication
- set up an NTP connection for date/time synchronization
- install wireless network radio certificates
- set up an HL7[®] Direct Connection to enable a Welch Allyn device to directly send patient queries and vitals to an EMR

Active Directory and HL7 (Direct EMR Connection) features are used to identify, authenticate, and authorize users/clinicians via clinician query from the device.

These instructions apply to the following device(s):

- Connex[®] Integrated Wall System, 2.43.00 or higher

Related documents

When using this manual, refer to the following:

- *Welch Allyn Network Installation Best Practices 80018745*
- *Welch Allyn Vitals Device HL7 Interface 60080809 IDS*
- *Welch Allyn[®] Configuration Tool Reference guide 80027311*
- Welch Allyn Service Tool:
<https://www.hillrom.com/en/services/welch-allyn-service-tool/>
- *Welch Allyn Service Tool Installation and configuration guide:*
<https://www.hillrom.com/en/services/welch-allyn-service-tool/>
- Hillrom website: hillrom.com

Definitions

Acronym/Term	Description
AD	A directory service developed by Microsoft for providing tree-structured information. Used for authenticating and authorizing users of the device.

Acronym/Term	Description
Clinician Authentication	Workflow feature where a clinician is required to log in to the device. The device will assure a clinician's credentials are valid by providing an interface where the clinician logs in to the device using their ID and password, and the ID and password are validated by an authority system on the network (e.g. Active Directory).
Clinician Identification	Workflow feature where the clinician enters their ID into the device so the Clinician ID can be logged with the vitals.
Clinician Identifier	Configurable to be the clinician's User name, Account name, or Employee ID.
DC	Domain Component – In LDAP servers and Active Directory, a dotted domain name is split into domain components that form "dc=component" pairs separated by commas. Example: ad.welchallyn.com in an AD server will be "dc=ad,dc=welchallyn,dc=com"
FQDN	Fully Qualified Domain Name. The complete domain name of a computer on the Internet. Contains the host name and the full domain.
Gateway Software	A software application that can receive data from a device and convert the data to HL7 messages and then transmit that data via a TCP/IP socket.
HL7	Health Level 7 – A framework for the exchange, integration, sharing, and retrieval of electronic health information.
Host HL7 System or Host Application	Software System that receives the HL7 data from the device.
IDS	Interface Design Specification
LDAP	Lightweight Directory Access Protocol – An industry standard protocol for maintaining distributed directory information. Often used for user names and password information.
NTP	Network Time Protocol is a networking protocol for clock synchronization between computer systems. It is used by the devices to maintain accurate date/time in the devices.
Patient Confirmation	The act of the device configuration/behavior ensuring that the vitals record contains the patient context.
Patient Identification	The act of the device configuration/behavior that displays the patient context on the device and that allows the clinician to ensure the right vitals go to the right patient.
SSL	Secure Sockets Layer– A set of cryptographic protocols to provide security of communications over a network. SSL is a predecessor to TLS.

Acronym/Term	Description
Vitals Device	Generic names for CSM, CVSM, and CIWS.
X.509 Certificate	An X.509 certificate is a digital certificate that uses the widely accepted international X.509 public key infrastructure (PKI) standard to verify that a public key belongs to the user, computer or service identity contained within the certificate.

Architecture

*Optional setting within the device.

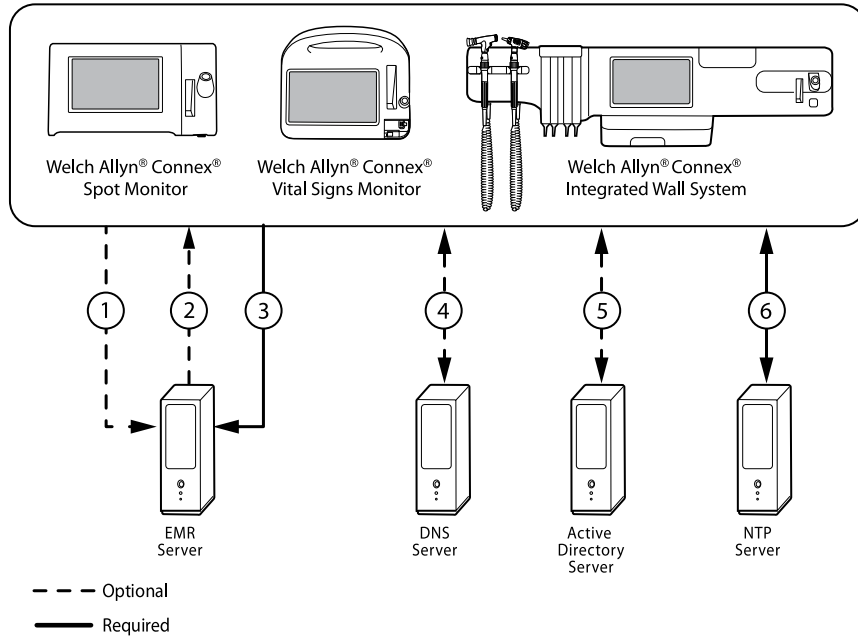

Server

EMR Server

- 1 Patient Query HL7 (QRY^A19) AES-128*
- 2 Patient Demographics HL7 (RSP^K22) AES-128*
- 3 Vitals HL7 (ORU^R01) AES-128*

DNS Server

- 4 DNS Lookup

Active Directory Server

- 5 Clinician Authentication

NTP Server

- 6 Date/Time Synchronization
-

Technical Specifications

Ports

Listening Port(s)	A single TCP/IP listening port on the EMR (or external server) needs to be available to receive connections from multiple devices.
-------------------	--

Computer Requirements

NTP Message Frequency	The NTP host solution(s) must be capable of processing time synchronization requests every 36 seconds (see IDS for calculation details).
Active Directory Message Frequency	The host solution(s) must be capable of processing clinician authentication requests every 36 seconds (see IDS for calculation details).
Patient Lookup and/or Vitals Send	The host solution(s) must be capable of processing patient lookup requests every 1.2 seconds (see IDS for calculation details).

Network

Internet Connection	An Internet connection may be required depending on how NTP is configured. If NTP is configured to use an external time server (e.g., time.nist.gov), then the device must be able to connect to the Internet.
---------------------	--

Device Support

Quantity	Some systems may scale up to and potentially beyond 400 devices, depending on the clinical environment.
Device(s)	Connex Integrated Wall System

Active Directory setup

Prerequisites:

- Confirm that the Date and Time are set correctly on the device.



NOTE This ensures that the device Date and Time fall between the Certificate Authority (CA) Root Certificate validity period for successful connection.

- Load the CA Root Certificate on the device and the Server Certificate on the Active Directory Server.



NOTE The connection to the Active Directory Server might fail due to a missing CA Root Certificate on the device and a missing Server Certificate on the AD Server. (See: "Import/Install an Active Directory server certificate on the Active Directory server" and "Import/Install a Certificate Authority (CA Root certificate on the Active Directory server)"). A CA can be either: Third-Party (GoDaddy, Symantec, Comodo) or Self-Signed - Internal CA (AD CS)

- Check the DNS Server IP assignment on the device via DHCP or Static configuration.
 - Make sure that the assigned DNS Server(s) on the device can successfully query for the Domain Name entered on the Active Directory User Interface.

CA Root Certificate format

- The CA Root Certificate can be either in PEM or DER format and can have extensions: ".pem", ".der", ".crt", or ".cer".
- These certificate files are converted into PEM format during the load process on the device.

Specify Active Directory settings

1. Access the Advanced Settings.
 - a. Touch the **Settings** tab.
 - b. Touch the **Advanced** tab.
 - c. Touch **Enter Password**.
 - d. Enter your password and touch **OK**.

The General tab appears.

2. Touch the **Network** tab.
3. Touch the **Active Directory** tab.

Active Directory settings

- Enable Active Directory (Turn the feature On or Off).



NOTE The device always uses TLS to encrypt communications between the Active Directory Server and the device. If an encrypted connection cannot be established, the device will not communicate with the server.



NOTE As part of establishing the TLS connection, the device software requests an X.509 certificate from the Active Directory Server and validates it against a stored CA Root certificate. If the AD Server cannot be validated, the device will not continue communications with the Active Directory Server.

CIWS

See the section "*Load a waclientcert.pim file to CIWS with a Newmar Radio to a USB flash drive*" for specific details about the CA Root Certificate loading process.

Active Directory- setup details (Best Practices)

Prerequisites

Set up the Active Directory and the DNS Servers and ensure that your version supports this feature.

The following sections describe how to configure and use the device's Active Directory feature for clinician authentication.

Configuration support for the Active Directory

Install required certificates

For the device to connect to Active Directory, you need to include the Active Directory CA (Certificate Authority) Root Certificate in the device configuration.



NOTE The CA Root Certificate must be in PEM or DER formats. Failure to abide by these restrictions will cause the device to ignore the certificate.

Examples of CA (Certificate Authority) include:

- Third party (GoDaddy, Symantec, Comodo, etc.)

or

- Internal CA (AD CS) - self-signed certificates

Import or install third-party or AD CS Certificate Authority certificates

Request and import/install the following AD CS Certificate Authority certificates:

- Server certificate on Active Directory Server via **Windows Certificate Store**
- CA Root Certificate on Active Directory Server via **Windows Certificate Store**

Install wireless network radio certificates

Wireless network authentication – radio certificates

Hillrom supports uploading your wireless certificates onto vital sign devices. Uploading certificates can be done using different methods based on the product design, however the certificates must be in a specific format and be named correctly for deployment on a device. This document does

not specify instructions for a specific server, however, it does provide information on support of wireless client certificates and wireless client certificates supporting server authentication. This support pertains to Hillrom products using the Newmar 802.11 a/b/g/n radio card and the Lamarr 802.11 a/b/g radio card.



NOTE Customer certificates that are uploaded to Hillrom devices must adhere to the x.509 standard.

Supported radio certificate formats

The 802.11 a/b/g/n radio supports a **DER** or **PEM** file format containing the **CA Root certificate** chain - cacert.der or cacert.pem.

The 802.11 a/b/g/n radio also supports the **P12**, **PFX**, or **PEM** file formats containing the device's **Client certificate** and private key - client.p12, or client.pfx, or client.pem.



NOTE If a P12 or PFX file is supplied, the Newmar Radio will automatically convert it to PEM format during installation.

No server validation – no certificates

Devices do not need to load the corresponding CA Root Certificate to authenticate.

A certificate does not need to be created for Server Validation (such as EAP-PEAP with Enable Server Validation - Unchecked).

No Certificates need to be loaded onto the devices for successful PEAP authentication. Only the following inputs are required:

- Username
- Password

The 'waclientcert.pim' file

For a certificate to be loaded to the 802.11 a/b/g/n radio using the Welch Allyn Service Tool (WAST), the certificate must be formatted into the 'waclientcert.pim' file format. This '.pim' file is a Hillrom specific container that includes the customer certificates, commands, information about how the certs are to be loaded, and information about which folders the certificate(s) will be written to on the radio file system.

You cannot re-name an existing customer client certificate or ca certificate to 'waclientcert.pim' and upload it because the certificate lacks information on where the certificates need to be deployed on the radio and how the product should handle the file. The 'waclientcert.pim' file must be created using a Welch Allyn process.

Create a waclientcert.pim file using the Welch Allyn Service Tool (WAST)

The Welch Allyn Service Tool (WAST) can create the '**waclientcert.pim**' file using only a 'ca cert' (server verification), or a 'ca cert' and 'client cert' (for client authentication).

1. Create a folder on the PC or thumb drive and place the ca cert, and if needed, the client cert in the same folder.
2. Connect a device to the PC running the WAST and allow the device to come up to a usable state.
3. Click **Select** to choose the desired device from the WAST 'Device list'.

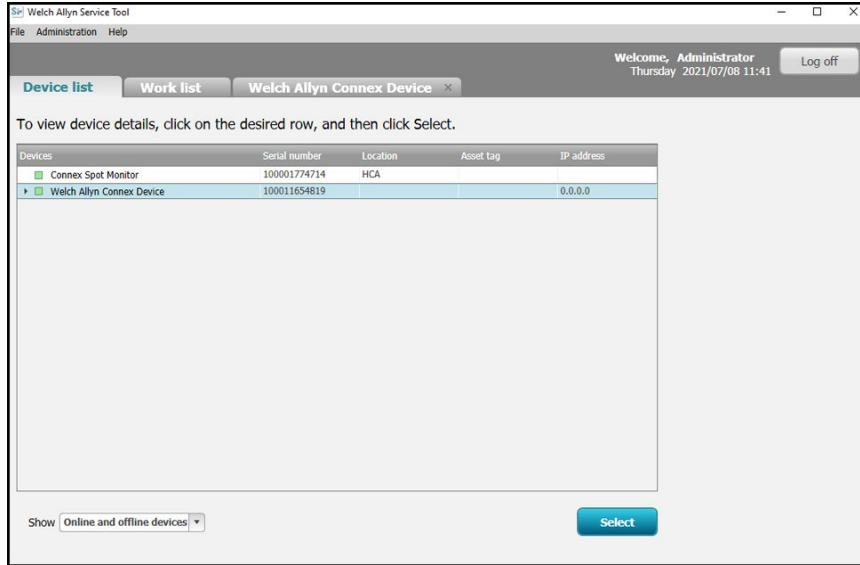

4. Click the *Configure* tab and then click **Change...** in the Current settings pane.

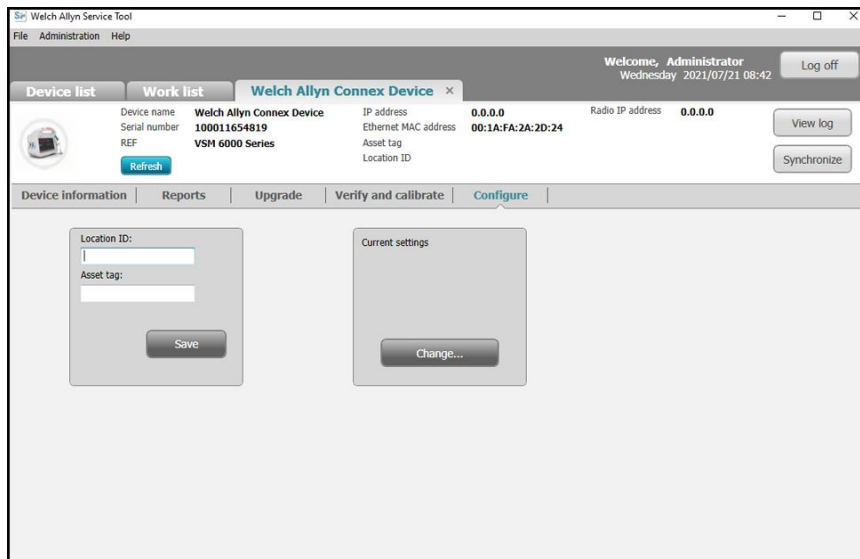

5. Select the *Network Policy Server Certificate* tab.

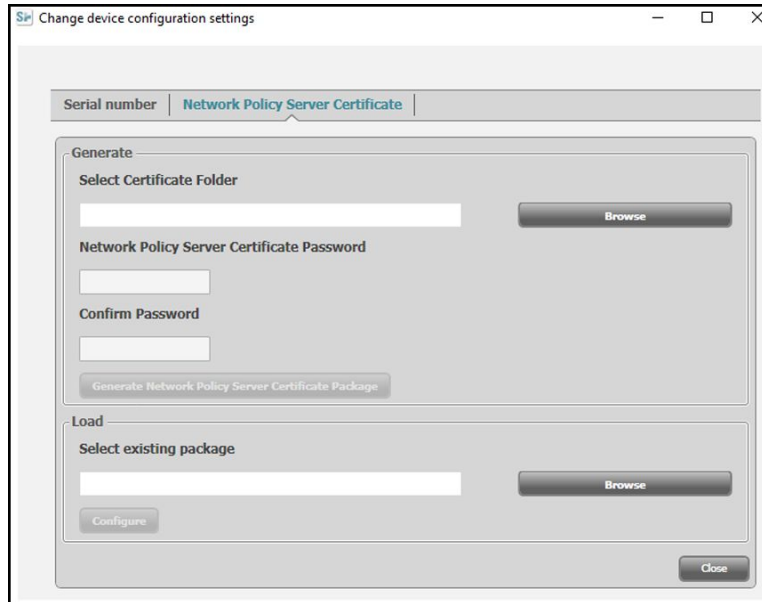

- Use the **Browse** button to select the folder where the customer certs are kept – this will fill in the *Select Certificate Folder* field with a path to the customer certificates.

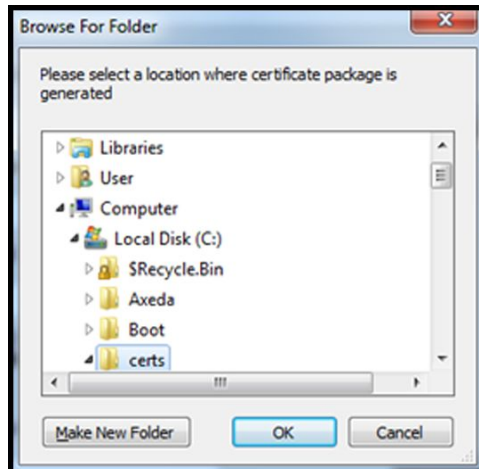

Server validation only certificate

If the certificate created for Server Validation (such as EAP-PEAP with **Enable Server Validation** checked), the folder created should only contain a 'ca cert'. A client certificate is not required.

The Network Policy Server Certificate Password and Confirm Password fields are inactive for editing, however, the device needs to load the corresponding CA Root Certificate to authenticate.

The CA Root Certificate needs to be loaded onto both the device for successful PEAP authentication.

- Username
- Password
- CA Root Certificate

Client authentication certificate

If the certificate to be created is for Client Authentication (such as EAP-TLS) the folder created should have a 'ca cert' and a 'client certificate'. The *Network Policy Server Certificate Password* field and *Confirm Password* field will need to be filled in with the password created for the client cert at creation time.

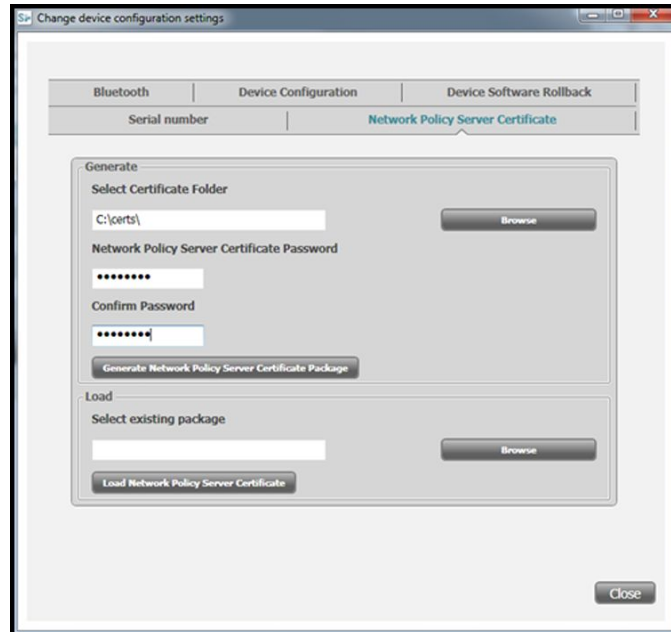

1. Once the folder path of the certificates is entered, (and the Server Verification Only or Client Authentication is chosen), click **Generate Network Policy Server Certificate Package** and a browse to the destination folder where the written 'waclientcert.pim' file will appear.

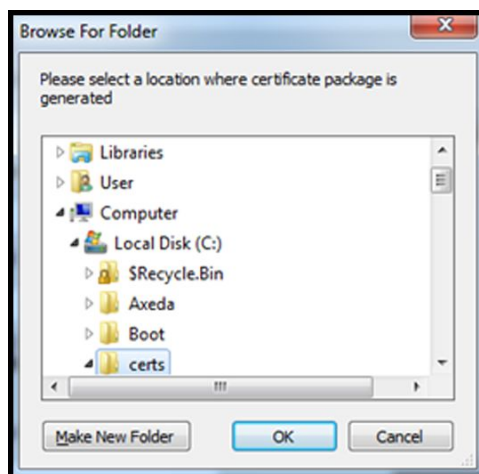

For convenience, we suggest writing the 'waclientcert.pim' file into the same directory as the certificate files.

2. After selecting the destination location and clicking OK, the 'Compressing', 'Generating', and 'Success' status windows appear.

The destination folder now contains the 'waclientcert.pim' file along with the certificate files.

Load a waclientcert.pim file onto the device with a Newmar Radio via the Welch Allyn Service Tool (WAST)

1. Disconnect the USB link between the PC and the device.
2. Launch the Welch Allyn Service Tool (WAST) on the PC.
3. Reboot the device and allow it to come up to a usable state.
4. Connect the USB link from the PC to the device.
5. Click **Select** to choose the desired device from the WAST 'Device list'.

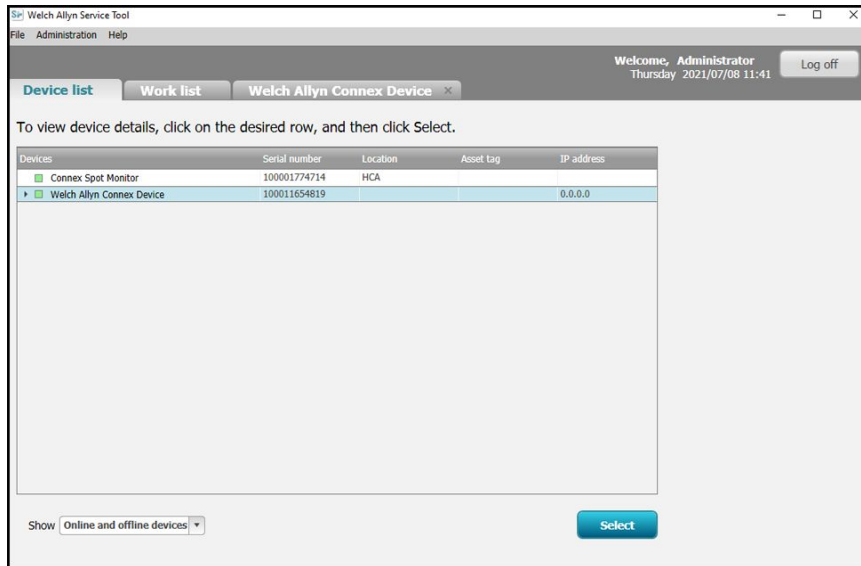

6. Click the *Configure* tab and then click **Change...** in the Current settings pane.

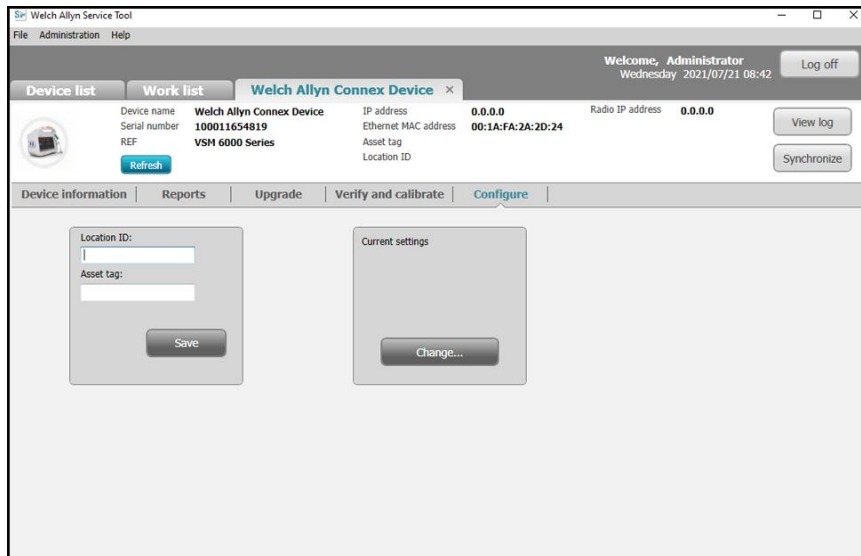

7. Select the *Network Policy Server Certificate* tab.

Change device configuration settings

Serial number | Network Policy Server Certificate

Generate

Select Certificate Folder

Network Policy Server Certificate Password

Confirm Password

Generate Network Policy Server Certificate Package

Load

Select existing package

Configure

Close

8. Click **Browse** from the *Load* pane and navigate to where the 'waclientcert.pim' file is located. The *Select existing package* field displays the path to the waclientcert.pim file.

Change device configuration settings

Serial number | Network Policy Server Certificate

Generate

Select Certificate Folder

Network Policy Server Certificate Password

Confirm Password

Generate Network Policy Server Certificate Package

Load

Select existing package

Configure

Close

9. Click **Configure** to load the certificate to the device radio.

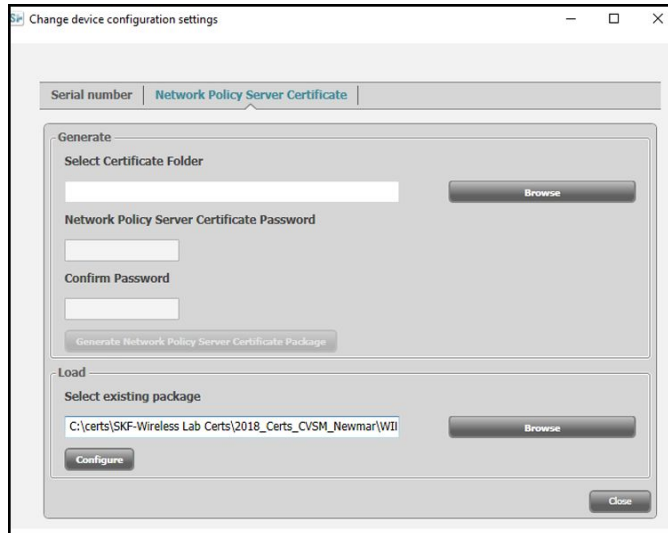

A message box displays the installation progress. The process should take a maximum of three minutes.



NOTE If the process moves past the 6-minute mark, disconnect the device from USB, reboot it and begin again.

- If the message box displays the message: *Network certificate package is loaded on device*, click **OK**.

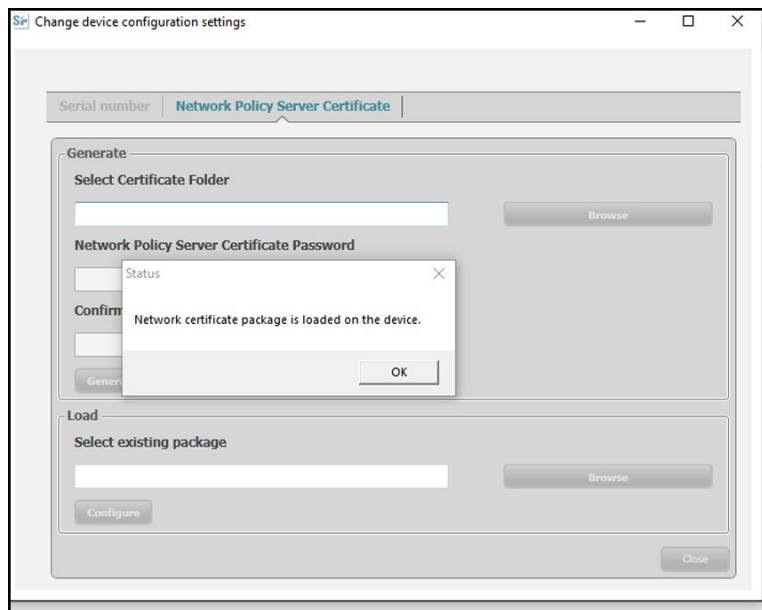

- Close the Welch Allyn Service Tool application.
- Disconnect the USB connection.
- Restart the device.

You can now configure the device to use certificates on the wireless network.

Load a `waclientcert.pim` file to CIWS (with a Newmar Radio) via a USB flash drive

Loading certificates to the CIWS is currently done by using the USB ports located within the communication panel.

- The USB must be formatted in FAT or FAT32.
- The certificates must be in the 'waclientcert.pim' format – but renamed to WIRELESS_CERT.pim in the root directory of the flash drive.



NOTE Do not place WIRELESS_CERT.pim in the CA_CERTIFICATES folder. CA_CERTIFICATES is not used for wireless radio certificates.

The same requirements for client authentication and server validation also apply. For more information, see "Load a waclientcert.pim file onto the device with a Newmar Radio via the Welch Allyn Service Tool (WAST)."

1. Insert the USB drive with the certificates.
2. Navigate to the **Settings > Advanced > Enter Password > General > Service** screen.
3. Touch **Configure from USB**.

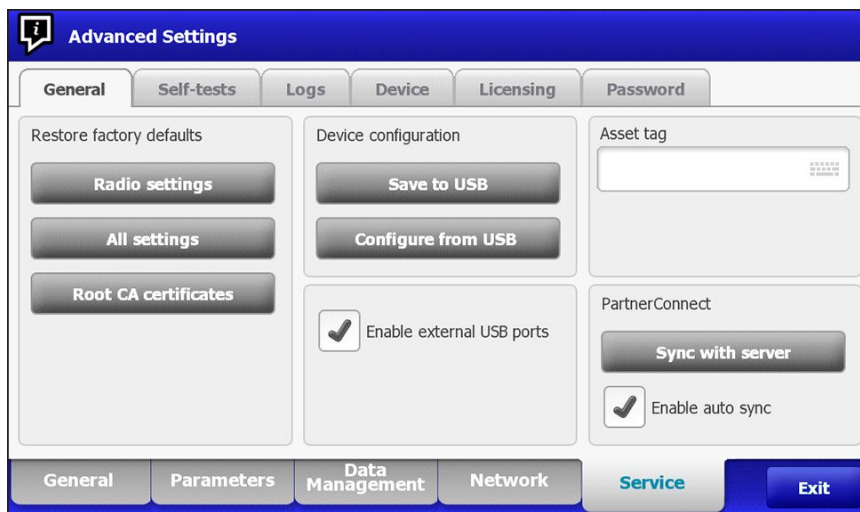

4. If the certificates are in the proper format and the USB drive is formatted properly, check the **Wireless certificate** box and touch **OK**.

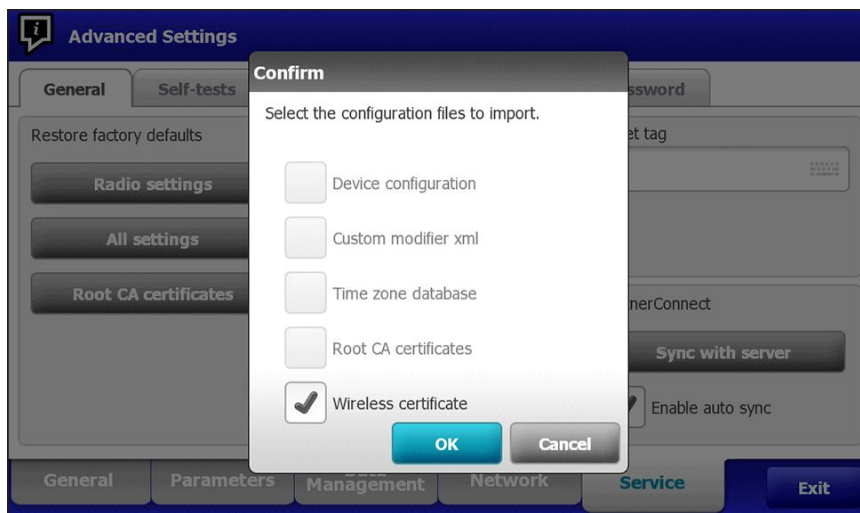

5. Touch **OK** at the prompt: "Select OK to confirm overwrite of existing device configuration or cancel."
6. The CIWS displays the "Device will be restarted" message and the system reboots.
7. After the CIWS reboots, navigate to the **Settings > Advanced > Network > Radio** screen.

8. Set the network parameters as needed.
9. If the network requires server authentication, check the **Server validation** box.

10. Touch **Configure radio**. If the network settings are correct, the device authenticates to the network.

The CIWS (Newmar) can now be configured to use certificates on the wireless network.



NOTE For CIWS (Newmar), the Restore Factory Defaults (Radio Settings or All Settings) deletes the wireless radio certificates on the device.

Load wireless certificates to CIWS (with a Lamarr Radio) via the web interface

- To load wireless radio certificates onto a CIWS (Lamarr), the CIWS (Lamarr) first needs to be connected to a WPA2-PSK WLAN.
- Make sure that certificates are in the valid format and that the certificates are named appropriately:
 - CA root certificate: cacert.pem
 - Client certificate: client.p12

Using Internet Explorer web browser, enter the IP address of the connected CIWS (Lamarr) device with WPA2-PSK WLAN as the URL:

Example: **http://xxx.xxx.xxx.xxx**

User Name: superadm

Password: Generated via the Password Generator with Lamarr Radio MAC address as input.



NOTE To check the status of the wireless radio certificates:

Under the Authentication and Encryption section:

- a. Select the **Certificate status tab**.
- b. Verify that **Customer CA Certificate Chain**> **Not Present**.
- c. Verify that **Customer Device Certificate and Private Key**> **Not Present**.

Loading CA Root Certificate on Lamarr Radio

1. Load the CA root certificate by selecting the **Customer CA certificate chain** tab.

Device information
SSID and radio band
Radio status
Authentication and Encryption
Certificate status
EAP settings
WPA2PSK settings
WEP64 settings
WEP128 settings
Force reauthentication
Upload
Web server certificate / key
Customer CA certificate chain
Customer device certificate / key
Web admin password
Radio Card Firmware Upload
Load CAB file

Upload customer CA certificate chain

Import a customer CA certificate chain in PEM format. All certificates in the chain must be uploaded in a single file. The root of the chain should be placed first.

Custom Certificate Chain

2. Click **Browse** to navigate to the CA Root Certificate file location on the PC.
3. Click **Apply** to load the CA root certificate onto the device.
4. Load the client certificate onto the Lamarr radio.
5. Under the *Upload* tab, click the **Customer device certificate / key** tab to load the client certificate.

Device information
SSID and radio band
Radio status
Authentication and Encryption
Certificate status
EAP settings
WPA2PSK settings
WEP64 settings
WEP128 settings
Force reauthentication
Upload
Web server certificate / key
Customer CA certificate chain
Customer device certificate / key
Web admin password
Radio Card Firmware Upload
Load CAB file

Upload customer device certificate and private key

Import a customer device certificate + private key in PKCS12 format (.p12).

Device certificate + key

Password

6. Click **Browse** to navigate to the Client Certificate file location on the PC.
7. Enter the **Password** for the client certificate.
8. Click **Apply** to load the Client Certificate onto the device.

To check the status of the wireless radio certificates:

1. Under the Authentication and Encryption section, click the **Certificate status** tab to view the Customer CA Certificate Chain >CA Root Certificate and the Customer Device Certificate and Private Key >Client Certificate details.

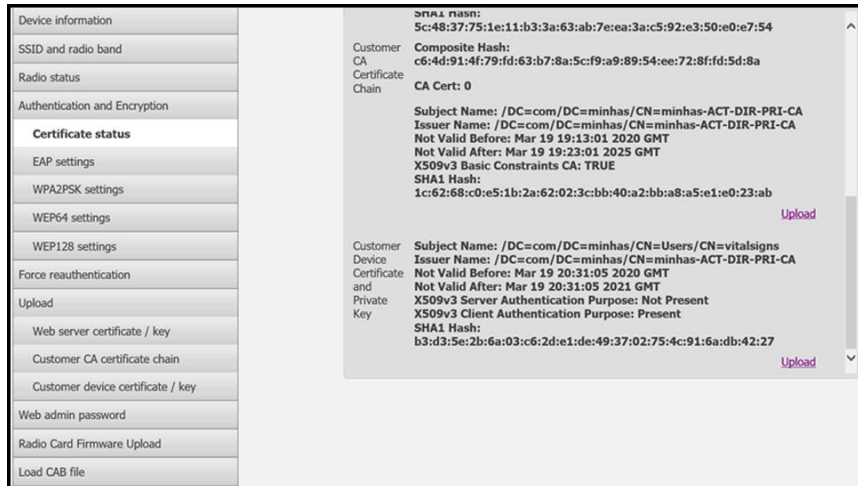

2. To confirm the presence of valid certificates on the CIWS (Lamarr) device, configure the Radio to an SSID with the authentication type: EAP-TLS.

A successful wireless connection with the SSID confirms the validity of wireless certificates.

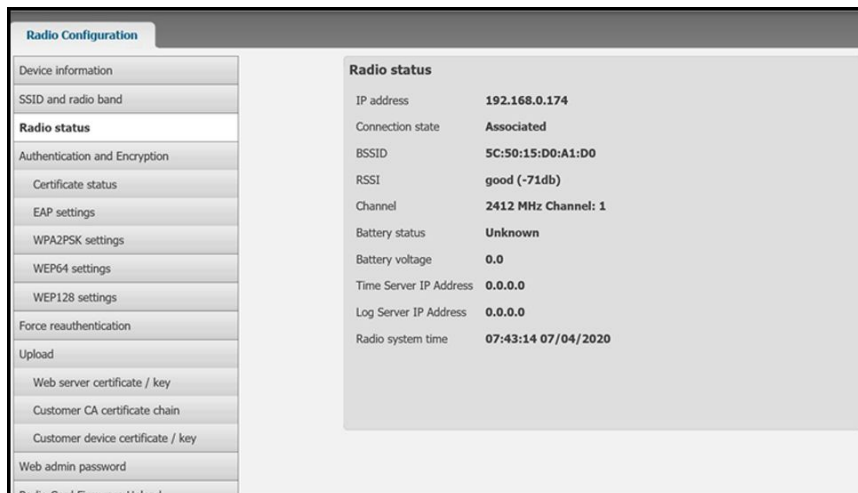

The CIWS (Lamarr) can now be configured to use certificates on the wireless network.



NOTE For CIWS (Lamarr), the Restore Factory Defaults (Radio Settings or All Settings) does not delete the Wireless Radio Certificates on the device.

Import/Install an Active Directory server certificate on the Active Directory server

These instructions apply to Active Directory servers with Windows Server 2012 OS and above:

1. Press the **Windows key + R** to bring up the Run command.
2. Type mmc and press **Enter** to open the Microsoft Management Console.

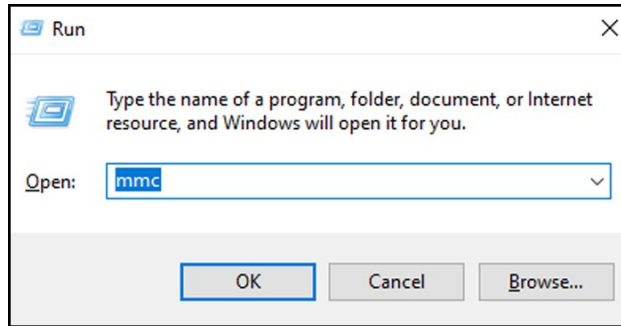

3. Click the **File** menu and then select **Add/Remove Snap-in...**
4. Select **Certificates** from the list of Snap-ins, and click **Add**.

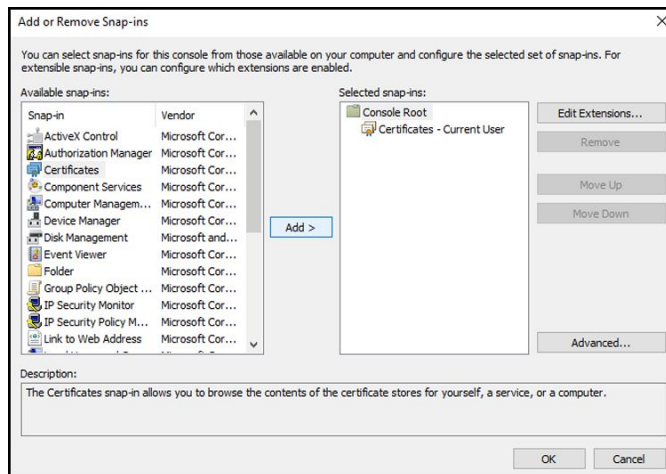

5. In the next dialog box, select **Computer account** and click **Next**.
6. Select **Local computer** and click **Finish**.
7. From the "Add or Remove Snap-ins" window, click **OK**.

Click > to view the certificates folder. When you open any certificates folder, you will see certificates displayed in the right pane.

8. Import/Install the AD Server Certificate into the following folder: Certificates (Local Computer) > Personal > Certificates.

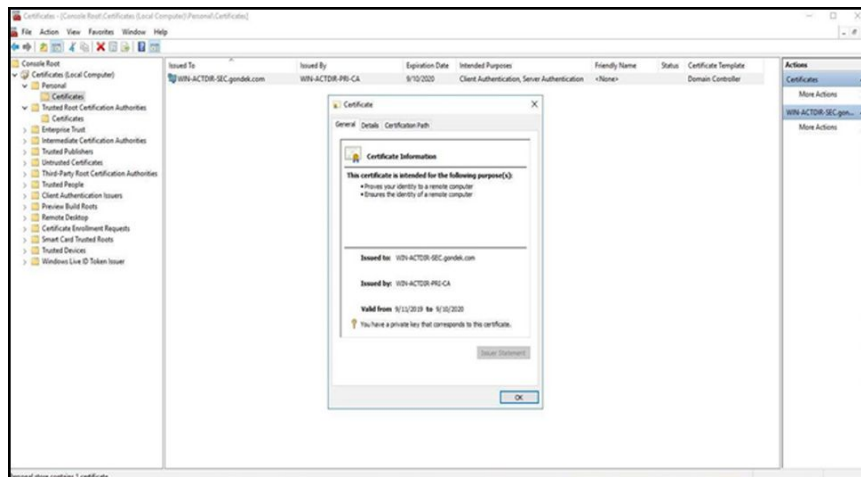

9. Right-click the Certificates folder under Personal and choose **All Tasks > Import**.

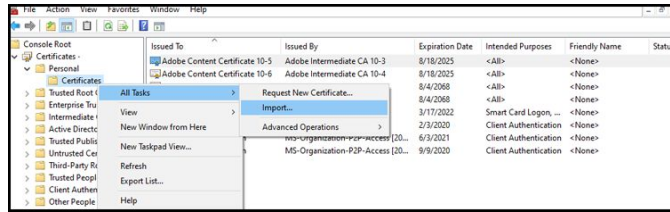

- Follow the Certificate Import Wizard and provide the Active Directory Server Certificate file path.



NOTE An example Active Directory server certificate is shown below.

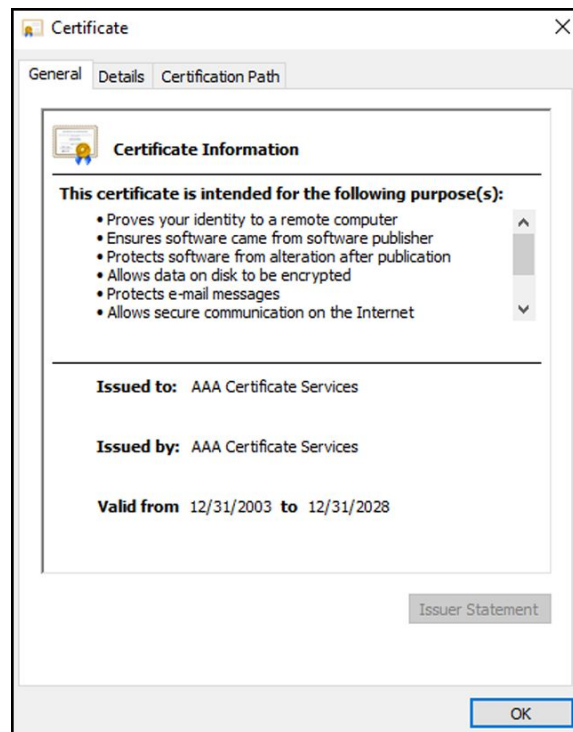

Import/Install a Certificate Authority (CA) Root certificate on the Active Directory server

These instructions apply to Active Directory servers with Windows Server 2012 OS and above:

- Press the **Windows key + R** to bring up the Run command.
- Type **mmc** and press **Enter** to open the Microsoft Management Console.

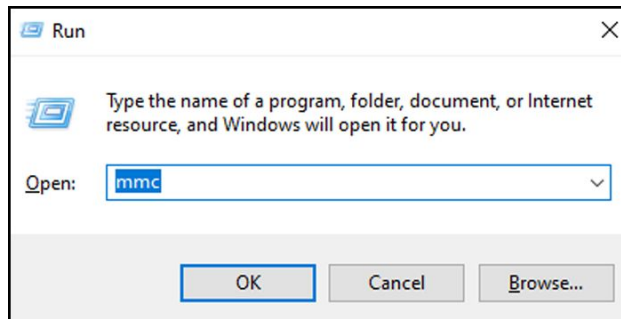

- Click the **File** menu and then select **Add/Remove Snap-in...**

4. Select **Certificates** from the list of Snap-ins, and click **Add**.

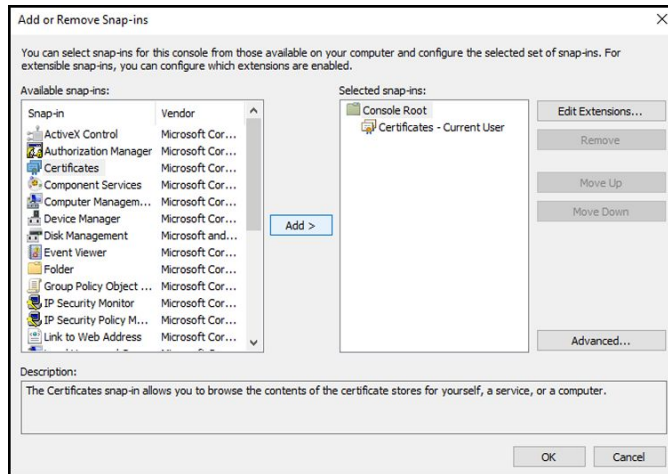

5. In the next dialog box, select **Computer account** and click **Next**.
6. Select Local computer and click **Finish**.
7. From the "Add or Remove Snap-ins" window, click **OK**.

Click > to view the certificates folder. When you open any certificates folder, you will see certificates displayed in the right pane.

8. Import/Install the CA Root Certificate into the following folder: Certificates (Local Computer) > Trusted Root Certification Authorities > Certificates.

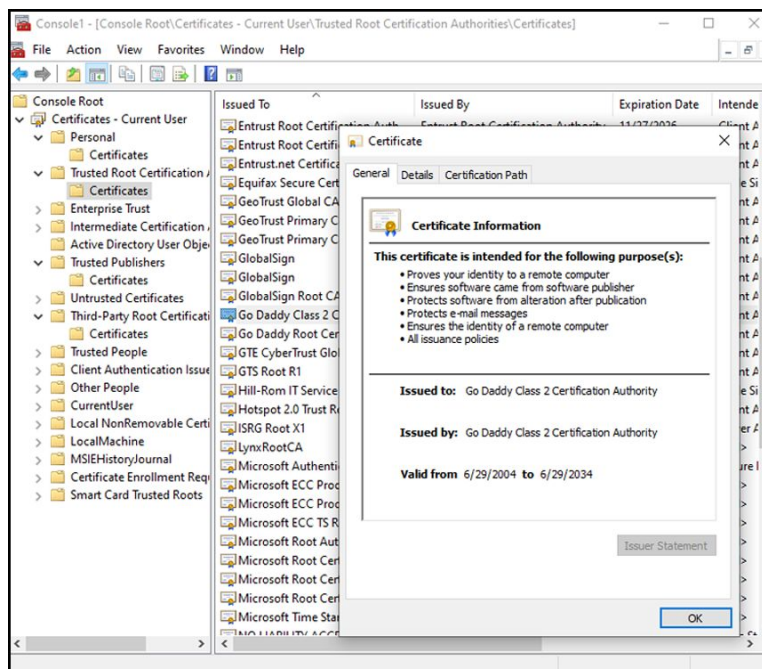

9. Right-click the Certificates folder under Trusted Root Certification Authorities and choose **All Tasks > Import**.

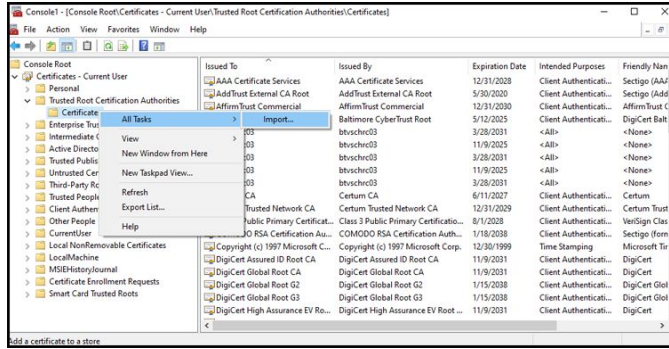

10. Follow the Certificate Import Wizard and provide the CA Root Certificate file path.



NOTE An example CA Root Certificate is shown below.

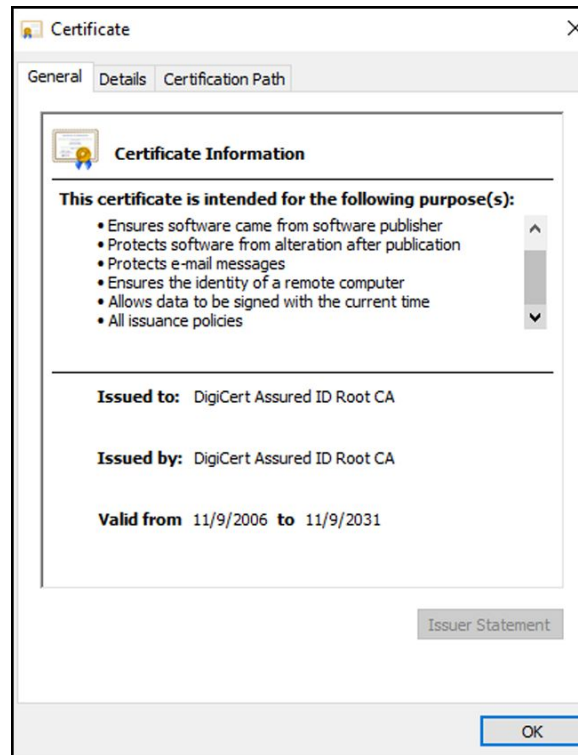

Import/Install a CA Root Certificate onto the device (includes CSM, CVSM, and CIWS)

Use the WA CSM Configuration Tool web application to install or import a CA Root Certificate onto the device. The Config file (*.signed.waconfig) is generated by the Configuration Tool. See "Log into the Configuration Tool" and "Configure a CA Root certificate using the Configuration Tool".

Create third party AD CS Certificate Authority Certificates

Third Party Certificates (AD Server & CA Root) need to be requested from the Third Party Certificate Authority with the required Active Directory Server information.

AD CS Certificates (AD Server & CA Root) are auto-generated during the AC CS Role Installation and Configuration on the AD Server. No specific process is required after the installation and configuration of the AD CS Role on the AD Server to generate these certificates.

HL7 out-of-box - setup details

HL7 (Direct EMR connection) setup

1. Access the Advanced Settings.
 - a. Touch the **Settings** tab.
 - b. Touch the **Advanced** tab.
 - c. Touch **Enter Password**.
 - d. Enter your password and touch **OK**.
The General tab appears.
2. Touch the **Network** tab.
3. Touch the **Server** tab.
4. Select **Manual Entry** from the drop-down list of the Connectivity method.
5. Select **Direct EMR Connection** from the Server drop-down list.

6. Select **Data encryption** to turn the Security on or off.

If Data encryption is enabled, then Server Authentication can be turned on or off. Data encryption is intended to keep data secure while the data is transferred over a network.



NOTE Check or Uncheck Data encryption per the intended Secure (TLS) or unsecure connection.

7. Select **Authentication** to turn the server authentication on or off.



NOTE Server Authentication is the process of confirming the identity of the EMR Server by receiving a server certificate from the server and checking it against the installed CA Root certificates on the device.

- If checked, confirm that CA Root Certificate is loaded on the device and that the Server Certificate is loaded on the EMR Server for the successful connection.
- If unchecked, the CA Root Certificate on the device and Server Certificate on the EMR Server are not required for the successful connection.

8. Touch the keyboard to enter an **IP Address**, **Episodic server host name**, or **FQDN** of the EMR Server in the *Episodic server host name or IP address* field.

9. Touch the keyboard to enter an **IP Address, Continuous server host name**, or **FQDN** in the *Continuous server host name or IP Address* field for the Continuous server that is listening for a connection.
10. Touch the keyboard to enter an **IP Address, Service server host name**, or **FQDN** of the Service server in the *Service server host name or IP address* field.
11. If needed, touch the keypad to enter a **Port** number in the *Port* field for the Episodic, Continuous, or Service server that is listening for a connection.
12. Touch **Test** to test the connection of the device to the EMR Server.

NTP server- setup details

Set up the NTP server

1. Access the Advanced Settings.
 - a. Touch the **Settings** tab.
 - b. Touch the **Advanced** tab.
 - c. Touch **Enter password**.
 - d. Enter your password and touch **OK**.
The General tab appears.
2. Touch the **Date/Time** tab.
3. Touch the **Enable NTP** checkbox to enable NTP.



NOTE Check the *Enable NTP* option as the first step of connecting with the NTP server to synchronize the device Date/Time clock over the internal or external (Internet) network.

4. Enter the Host name or IP address of the NTP server.
To enter this information, touch the keypad in the Host name or IP address text field and enter either the Host name or IP address of the NTP server.
5. Touch **Test** to test the connection of the device to the NTP Server and to synchronize the device Date/Time.

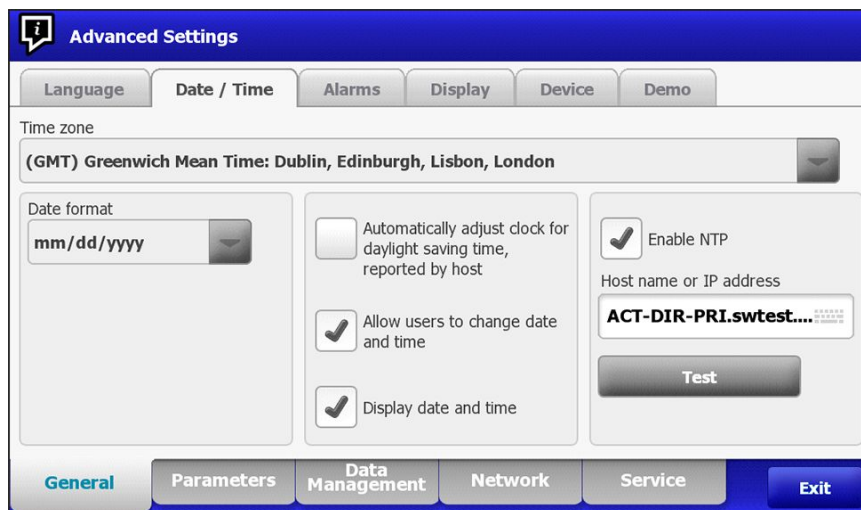

Project workflow

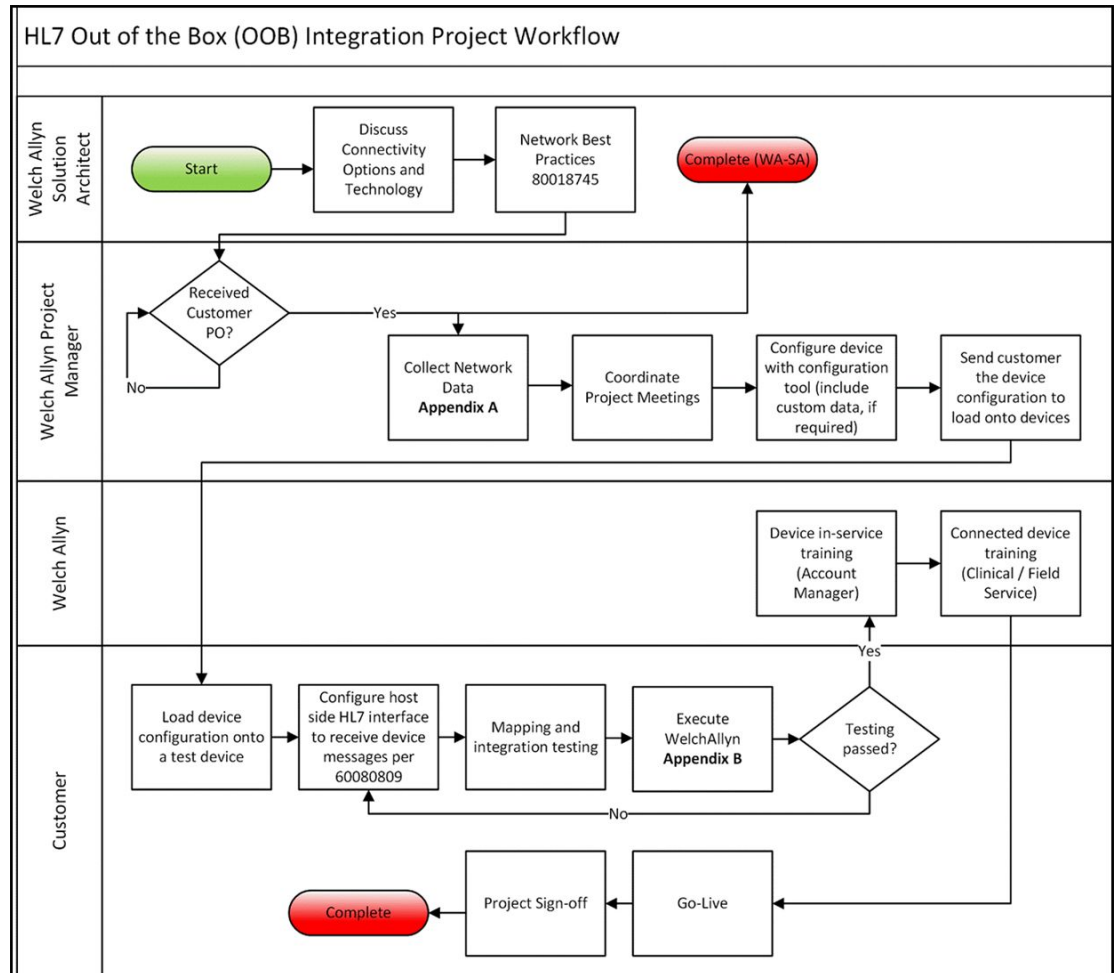

Troubleshooting

Problem	Possible cause	Suggested action
Date/Time "Test network connection" failed	The device is not connected to a network and therefore does not have an IP address	Verify that the device has an IP address: Settings > Advanced > "IP address".
	The device does not have a properly configured NTP server	Review the NTP server configuration and make sure NTP is properly configured.
	The device does not have a properly configured NTP connection	Verify the Date/Time configuration on the device: Settings > Advanced > General > Date/Time: <ol style="list-style-type: none"> "Enable NTP" is checked. The proper NTP server address appears in the "Domain" field (Domain, FQDN, or IP Address).
	The device does not have Internet connectivity	Connect the device to the Internet. (An Internet connection is required when the NTP server is outside the local network.
	Your network firewall is blocking UDP port 123	Verify that the network's NTP port is open: typically, UDP 123.
	The path to NTP server cannot be reached	The path to NTP server cannot be reached
Server "Test network connection" failed	The device is not connected to a network and therefore does not have an IP address	Verify that the device has an IP address: Settings > Advanced > IP address.
	The device does not have a properly configured HL7 server connection	Verify the server configuration on the device: Settings > Advanced > Network > Server: <ol style="list-style-type: none"> Server connectivity = Direct EMR Connection. Host IP is selected. The proper address appears in the Host Address field (FQDN or IP Address). The proper port appears in the Host Port field.
	Server authentication failed	Load the proper Root Certificate on the server and the proper CA Root Certificate in the device using the device configuration tools.

Problem	Possible cause	Suggested action
	Your network firewall is blocking the TCP port used for the HL7 host connection	Verify that the network's TCP host port is open.
	The path to EMR server cannot be reached	Check network topology to ensure there's a valid path from the device to the EMR server.
Active Directory "Test network connection" failed	The device is not connected to a network and therefore does not have an IP address	Verify that the device has an IP address: Settings > Advanced > IP address.
	The device does not have a properly configured Active Directory server connection	<p>Verify the server configuration on the device: Settings > Advanced > Network > Active Directory:</p> <ul style="list-style-type: none"> a. "Enable Active Directory" is selected. b. The proper domain name appears in the "Domain name" field. c. The proper group name appears in the "Group" field. d. You are using the proper Clinician ID type, it matches what you are scanning, and the clinician is in the Active Directory. e. You are using the proper Authentication User name. f. You are using the proper Authentication password.
	Server authentication failed	Load the proper Root Certificate on the server and the proper CA Root Certificate in the device using the device configuration tools.
	Path to Active Directory server cannot be reached	Check network topology to ensure there's a valid path from the device to the Active Directory server.
Date/Time is incorrect on the device	Time zone is configured incorrectly	Confirm the device's time zone configuration is set to the correct time zone.
	DST adjustment is not configured correctly	Configure the DST setting appropriately (enable or disable DST adjustment depending on location).

Problem	Possible cause	Suggested action
	The device is syncing time to a different source than the rest of the network	Configure the device to configure its date and time to the same source as the rest of the network.
Failed to identify a patient	The device is not connected to a network and therefore does not have an IP address	Verify that the device has an IP address: Settings > Advanced > IP address.
	The device does not have a properly configured HL7 server connection	Verify the server configuration on the device: Settings > Advanced > Network > Server: <ul style="list-style-type: none"> a. "Server connectivity" = Direct EMR Connection. b. "Host IP" is selected. c. The proper address appears in the "Host Address" field (FQDN or IP Address). d. The proper port appears in the "Host Port" field.
	Scanned patient ID is not the proper barcode	Verify the patient ID scanned is a valid patient ID barcode.
	Scanned patient ID could not be found in the host database containing the patient census	Verify the patient ID scanned is in the host database.
	The HL7 host is not properly configured to receive census query requests	Verify that the host is configured to receive census query requests on the configured port.
	Your network firewall is blocking the TCP port used for the HL7 host connection	Verify that the network's TCP host port is open.
	Server authentication failed	Load the proper Root Certificate on the server and the proper CA Root Certificate in the device using the device configuration tools.
Failed to authenticate a user	The device is not connected to a network and therefore does not have an IP address	Verify that the device has an IP address: Settings > Advanced > IP address.
	Scanned Clinician ID is not the proper barcode	Verify the Clinician ID scanned is a valid Clinician ID barcode.
	Scanned Clinician ID is not contained in the user authentication database	Verify the Clinician ID scanned is in the user authentication database.

Problem	Possible cause	Suggested action
	The device does not have a properly configured Active Directory server connection	Verify the server configuration on the device: Settings > Advanced > Network > Active Directory: a. "Enable Active Directory" is selected. b. The proper domain name appears in the "Domain name" field. c. The proper group name appears in the "Group" field. d. You are using the proper Clinician ID type, it matches what you are scanning, and the clinician is in the Active Directory. e. You are using the proper Authentication User name.
	User ID entered is not valid	Verify that the user ID entered is accurate and a valid ID in the Active Directory.
	Server authentication failed	Load the proper Root Certificate on the server and the proper CA Root Certificate in the device using the device configuration tools.
Failed to send vitals	The device is not connected to a network and therefore does not have an IP address	Verify that the device has an IP address: Settings > Advanced > IP address.
	The device does not have a properly configured HL7 server connection	Verify the server configuration on the device: Settings > Advanced > Network > Server: a. Server connectivity = Direct EMR Connection. b. Host IP is selected. c. The proper address appears in the Host Address field (FQDN or IP Address). d. The proper port appears in the Host Port field.
	Your network firewall is blocking the TCP port being used for the HL7 host connection	Verify that the network's TCP host port is open.
	Server authentication failed	Load the proper Root Certificate on the server and the proper CA Root Certificate in the device using the device configuration tools.

Problem	Possible cause	Suggested action
	The configured custom data cannot be imported into the EMR	Verify the custom data configuration and make sure the fields going to the EMR match what the EMR is expecting.
	EMR response does not match device interface	Verify EMR response to the device's HL7 interface specification.
	The EMR rejected the Clinician ID	Verify Clinician ID sent from the device is a valid Clinician ID for the EMR.
	EMR or interface engine is down	Call your EMR or system administrator.
	Data was rejected for one of the following reasons: <ul style="list-style-type: none"> • Patient ID not found • Clinician ID not found • vitals date/time in the future • device received a message timeout notification 	Check the EMR or interface engine message logs to determine root cause.

Troubleshooting the CVSM/CIWS (Newmar & Lamarr)

The CVSM/CIWS do not have a direct connection to the radio through a debug connection, so all troubleshooting will be done on the device.

Verify if a CA Root certificate is loaded on the radio

To check if the CA Root certificate is loaded, navigate to: Advanced > Network > Radio

- Enable radio selected
- ESSID = Enter an WPA2-Enterprise SSID
- Set the Authentication type to WPA2-Enterprise (Newmar) or WPA2-AES (Lamarr)
- Set the EAP Type to PEAP-MSCHAPv2 (Newmar) or PEAP (Lamarr)
- Check the Server validation box
(Newmar Only - Lamarr doesn't have Server validation option)
- Enter valid Identity & Password
- Touch **Configure radio**

Newmar

If the "*Configuration invalid without certificates. Install certificates and try again.*" message appears in the banner, the CA Root Certificate is not loaded.

Lamarr

If the CVSM/CIWS does not connect to the WLAN, the CA Root Certificate is not loaded.

Verify if a Client certificate is loaded

To check if the Client certificate is loaded, navigate to: Advanced > Network > Radio

- Enable radio selected
- ESSID = Enter an WPA2-Enterprise SSID
- Set the Authentication type to WPA2-Enterprise (Newmar) or WPA2-AES (Lamarr)
- Set the EAP Type to TLS
- Check the Server validation box
(Newmar Only - Lamarr doesn't have Server validation option)
- Enter valid Identity
- Touch **Configure radio**

Newmar

If the "*Configuration invalid without certificates. Install certificates and try again.*" message appears in the banner, the Client Certificate is not loaded.

Lamarr

If the CVSM/CIWS does not connect to the WLAN, the CA Root Certificate is not loaded.



NOTE Newmar Radio version 2.00.02 will encrypt the password file which is stored at: /etc/welchallyn/clientpassword or /pacpassword.

Service record

Print the Service record pages to enter and save the results of your tests.

Date:	Time:
Device name:	Serial number:
Technician:	Service tool version:

Leak test

Leak test	Specification	Actual reading	Pass	Fail
Leak test:	Max: 5			

Overpressure test

Overpressure test	Specification	Actual reading
Over Pressure Test:	Adult mode: 280 ... 329	
	Neonate mode: 130 ... 164	

NIBP accuracy check

Target pressure ± 5 mmHg	Pressure meter	Service tool	Specification	Pass	Fail
0 mmHg	mmHg	mmHg	± 1 mmHg		
50 mmHg	mmHg	mmHg	± 3 mmHg		
150 mmHg	mmHg	mmHg	± 3 mmHg		

250 mmHg	mmHg	mmHg	± 3 mmHg
----------	------	------	----------

Masimo SpO₂, SpHb, and heart rate tests

Test	Specification	Actual reading	Pass	Fail
SpO ₂ heart rate 60 bpm	Pulse rate 60 ±1 bpm 59 to 61 bpm	bpm		
SpO ₂ saturation 81%	Saturation 81% ±3% 78 to 84%	%		
SpHb g/dL 14 g/dL	SpHb 14 g/dL ±1 g/dL 13 g/dL to 15 g/dL	g/dL		

Nellcor SpO₂ and heart rate test

Test	Specification	Actual reading	Pass	Fail
SpO ₂ heart rate 60 bpm	Pulse rate 60 ±1 bpm 59 to 61 bpm	bpm		
SpO ₂ saturation 90%	Saturation 90% ±1 sat point 89 to 91%	%		

Calibration key temperature test for SureTemp Plus

Temperature test	Specification ± 0.2°F (± 0.1°C)	Actual reading	Pass	Fail
97.3 °F (36.3°C)	97.1 to 97.5°F 36.2 to 36.4°C	°F or °C		

SureTemp Plus test

9600 Plus Calibration Tester ID number		Calibration Date		Next Calibration Due Date	
Temperature tested	Specification	Range		Actual reading	Pass Fail
96.8 °F (36.0 °C)	± 0.3 °F (± 0.2 °C)	96.5 °F to 97.1 °F	35.8 °C to 36.2 °C	°F or °C	
101.3 °F (38.5 °C)	± 0.2 °F (± 0.1 °C)	101.1 °F to 101.5 °F	38.4 °C to 38.6 °C	°F or °C	
105.8 °F (41.0 °C)	± 0.3 °F (± 0.2 °C)	105.5 °F to 106.1 °F	40.8 °C to 41.2 °C	°F or °C	

Braun ThermoScan PRO 4000 or PRO 6000 test

9600 Plus Calibration Tester ID number		Calibration Date		Next Calibration Due Date	
Temperature tested	Specification ± 0.4 °F (± 0.2 °C)	Actual reading		Pass	Fail
96.8 °F (36.0 °C)	96.4 °F to 97.2 °F	35.8 °C to 36.2 °C			
101.3 °F (38.5 °C)	100.9 °F to 101.7 °F	38.3 °C to 38.7 °C			
105.8 °F (41.0 °C)	105.4 °F to 106.2 °F	40.8 °C to 41.2 °C			

ECG functional test record

Inspection of module and cables

Step	Acceptance criteria	Pass	Fail
1	No missing parts, cuts, cracks, or discoloration to ECG patient cables		
2	No missing parts, cuts, cracks, or discoloration to USB cable		
3	No broken plastic, cracks, discoloration, missing parts, or rattle to module		

ECG module LED test

Step	Acceptance criteria	Pass	Fail
1	ECG module LED is off		
3	ECG module LED is amber then steady green		
5	ECG module LED is flashing green		

Waveform and heart rate test

Step	Acceptance criteria	Displayed heart rate	Pass	Fail
3	Waveform present (normal sinus rhythm)	Lead I HR	♥/min	
5	Heart rate 80 ♥/min +/- 3 ♥/min	Lead II HR	♥/min	
5		Lead III HR	♥/min	
5		Lead V HR	♥/min	

Lead-off alarm test

Step	Acceptance criteria	Lead	Pass	Fail
1	Connex device displays the following messages:	RA or R		
3	Alert: Cannot analyze ECG.	LA or L		
3	Technical alarm: Lead off	RL or N		
3		LL or F		
3		V1 or C1		

Respiration test

Step	Acceptance criteria	RR	Pass	Fail
6	Respiration rate is 15 BPM +/- 2 BPM	BPM		

Arrhythmia alarm test

Step	Acceptance criteria	Delay	Pass	Fail
5	Asystole alarm triggered ≥ 4 seconds	seconds		

Pacemaker detection test

Step	Acceptance criteria	Lead	Pass	Fail
10	Pacer spike marker appears before each QRS complex	Lead I		
11		Lead II		
11		Lead III		
11		Lead V		