



**Hillrom™**

**Welch Allyn®  
Connex® Devices**



## Instructions for use

Software version 2.4X

© 2021 Welch Allyn. All rights are reserved. To support the intended use of the product described in this publication, the purchaser of the product is permitted to copy this publication, for internal distribution only, from the media provided by Welch Allyn. No other use, reproduction, or distribution of this publication, or any part of it, is permitted without written permission from Welch Allyn. Welch Allyn assumes no responsibility for any injury to anyone, or for any illegal or improper use of the product, that may result from failure to use this product in accordance with the instructions, cautions, warnings, or statement of intended use published in this manual.

Legal Statement. Welch Allyn, Inc. ("Welch Allyn") assumes no responsibility for any injury to anyone that may result from (i) failure to properly use the product in accordance with the instructions, cautions, warnings, or statement of intended use published in this manual, or (ii) any illegal or improper use of the product.

Welch Allyn, Connex, SureTemp, FlexiPort, and SureBP are registered trademarks of Welch Allyn.

Vital Signs Monitor 6000 Series and PartnerConnect are trademarks of Welch Allyn.

Integrated Pulmonary Index and Oridion and Microstream are trademarks of a Medtronic company. No implied license. Possession or purchase of this device does not convey any express or implied license to use the device with unauthorized CO2 sampling products which would, alone, or in combination with this device, fall within the scope of one or more of the patents relating to this device and/or CO2 sampling products.

Radical-7R, Pulse CO-Oximeter, rainbow Acoustic Monitoring, RRA, and ReSposable are trademarks of, and SET, LNCS, SpHb, rainbow, and Masimo are registered trademarks of, Masimo Corporation. Possession or purchase of a Masimo-equipped device does not convey any express or implied license to use the device with unauthorized sensors or cables which would, alone or in combination with this device, fall within the scope of one or more of the patents relating to this device.

Nellcor SpO2 Patient Monitoring System with OxiMax Technology and Nellcor SpO2 OxiMax Technology are trademarks of a Medtronic company.

Braun and ThermoScan are registered trademarks of Braun GmbH.

Health o meter is a registered trademark of Sunbeam Products, Inc., used under license.

EarlySense is a registered trademark of EarlySense Ltd.

Software in this product is Copyright 2021 Welch Allyn or its vendors. All rights are reserved. The software is protected by United States of America copyright laws and international treaty provisions applicable worldwide. Under such laws, the licensee is entitled to use the copy of the software incorporated with this instrument as intended in the operation of the product in which it is embedded. The software may not be copied, decompiled, reverse-engineered, disassembled, or otherwise reduced to human-perceivable form. This is not a sale of the software or any copy of the software; all right, title, and ownership of the software remain with Welch Allyn or its vendors.

This product may contain software known as "free" or "open source" software (FOSS). Hill-Rom uses and supports the use of FOSS. We believe that FOSS makes our products more robust and secure, and gives us and our customers greater flexibility. To learn more about FOSS that may be used in this product, please visit our FOSS website at [hillrom.com/opensource](http://hillrom.com/opensource). Where required, a copy of FOSS source code is available on our FOSS website.

PATENTS / PATENT [hillrom.com/patents](http://hillrom.com/patents)

May be covered by one or more patents. See above Internet address. The Hillrom companies are the proprietors of European, US, and other patents and pending patent applications.

For Nellcor patent information, please visit [www.medtronic.com/patents](http://www.medtronic.com/patents).

For information about any product, contact Hillrom Technical Support: <https://hillrom.com/en-us/about-us/locations>.

**REF** 80026006 Ver. C

Revision date: 2021-10



Welch Allyn, Inc.  
4341 State Street Road  
Skaneateles Falls, NY 13153 USA

Welch Allyn, Inc. is a subsidiary of Hill-Rom Holdings, Inc.

[hillrom.com](http://hillrom.com)

This manual applies to **#** 901060 Vital Signs Monitor and **#** 901028 Connex Integrated Wall System.

Authorized Australian Sponsor  
Welch Allyn Australia Pty. Ltd.  
Unit 4.01, 2-4 Lyonpark Road  
Macquarie Park, NSW 2113  
Phone 1 800 650 083

**EC REP** and EU Importer

Welch Allyn Limited  
Navan Business Park  
Dublin Road  
Navan, Co. Meath  
C15 AW22  
Ireland



Hillrom™



Global Instrumentation, LLC



# Contents

---

<b>Introduction .....</b>	<b>1</b>
Connex Vital Signs Monitor 6000 Series .....	1
Connex Integrated Wall System .....	1
Indications for use .....	2
Contraindications .....	3
 <b>Symbols .....</b>	 <b>5</b>
 <b>Screen elements .....</b>	 <b>9</b>
 <b>About warnings and cautions .....</b>	 <b>15</b>
General warnings and cautions .....	15
 <b>Physical design .....</b>	 <b>27</b>
Vital Signs Monitor 6000 Series .....	27
Integrated Wall System .....	31
 <b>Setup .....</b>	 <b>35</b>
Vital Signs Monitor 6000 Series .....	35
Supplies and accessories .....	35
Insert the battery .....	35
Mount the monitor .....	36
Attach the probe well .....	37
Attach the temperature probe .....	38
Remove the temperature probe and well .....	38
Connect the NIBP hose .....	39
Disconnect the NIBP hose .....	39
Connect the SpO2 cable or the SpO2/RRa dual cable .....	39
Disconnect the SpO2 cable or the SpO2/RRa dual cable .....	41
Connect the patient movement cable .....	41
Disconnect the patient movement sensor and cable .....	42
Attach a USB accessory .....	42
Detach a USB accessory .....	43
Insert a new roll of paper .....	43
Connect AC power .....	44
Disconnect AC power .....	45
Integrated Wall System .....	45
Supplies and accessories .....	45
Unpack the wall system .....	45
Insert the battery .....	46
Prepare for mounting .....	47
Mounting location .....	49
Mount the wall system .....	49

Mount the accessory bin .....	53
Connect the blood pressure (NIBP) hose .....	55
Set up the physical assessment instrument handles and specula dispenser .....	55
Set up the SureTemp® Plus thermometer .....	56
Set up the Braun ThermoScan® PRO thermometer .....	57
Connect AC power .....	58
Attach an accessory .....	58
<b>Startup .....</b>	<b>61</b>
Power .....	61
Power up the monitor .....	62
Set the date and time .....	63
Power down the monitor .....	63
Reset the monitor .....	64
Single sign-on (SSO) .....	64
Patient Protection mode .....	66
<b>Navigation .....</b>	<b>67</b>
Home tab .....	67
Device Status area .....	67
Content area .....	70
Navigation area .....	72
<b>Using the keypad, keyboard, and barcode scanner .....</b>	<b>77</b>
Open the numeric keypad .....	77
Numeric keypad .....	77
Enter a number .....	78
Close the numeric keypad .....	78
Open the keyboard .....	78
Keyboard .....	79
Enter a letter or number .....	80
Enter a symbol or special character .....	80
Enter a diacritical mark .....	81
Close the keyboard .....	81
Use a barcode scanner .....	82
<b>Host system .....</b>	<b>83</b>
Overview .....	83
Monitor tab .....	84
Connect to the central station .....	85
Disconnect from the central station .....	85
Continuous patient monitoring .....	85
Activate the Continuous Monitoring profile .....	86
Pause continuous monitoring (Pause mode) .....	87
Resume continuous monitoring .....	87
End continuous monitoring .....	88
Assign a patient and location .....	88
<b>Profiles .....</b>	<b>91</b>
Continuous Monitoring profile .....	91
Saving vital sign measurements (Continuous Monitoring profile) .....	93
Manual episodic vital sign measurements (Continuous Monitoring profile) .....	93
Intervals Monitoring profile .....	97

Spot Check profile .....	97
Office profile .....	98
Saving vital sign measurements (Intervals Monitoring, Spot Check, and Office profiles) ...	99
Profile feature comparison .....	100
Changing profiles .....	101
<b>Patient data management .....</b>	<b>107</b>
Add a patient to the patient list .....	107
Load patient data with a barcode scanner .....	108
Select a patient .....	108
Office profile .....	110
Manage patient records (Continuous Monitoring profile) .....	111
Manage patient records (Intervals Monitoring, Spot Check, and Office profiles) .....	113
Printer .....	115
Delete a patient from the list .....	117
<b>Alarms .....</b>	<b>119</b>
Patient rest mode .....	124
Reset (pause or turn off) audio alarms .....	125
Cancel a paused alarm .....	126
Adjust vital sign alarm limits .....	126
Adjust ECG and Impedance Respiration alarm limits .....	128
Modify audio alarm notification .....	129
Alarm messages and priorities .....	130
Nurse call .....	135
<b>Patient monitoring .....</b>	<b>137</b>
Configuration tool .....	137
Standard and custom modifiers .....	137
Custom scoring .....	138
Manual overrides .....	138
Patient movement .....	138
Capnography (CO <sub>2</sub> ) .....	144
Respiration rate .....	148
IPI .....	150
Acoustic respiration rate (RRa) .....	153
NIBP .....	156
Temperature .....	172
SpO <sub>2</sub> .....	184
SpHb .....	190
ECG .....	194
Pulse rate frame .....	203
Manual parameters frame .....	204
Physical assessment instrument handles .....	206
<b>Maintenance and service .....</b>	<b>209</b>
Perform periodic checks .....	209
Replace the printer paper (Connex VSM) .....	209
Change the battery (Connex VSM) .....	210
Remove the wall system from the wall (Connex IWS) .....	212
Change the battery (Connex IWS) .....	213
Clean the monitor .....	214
Prepare to clean the equipment .....	215

Clean the accessories .....	215
<b>Advanced settings .....</b>	<b>217</b>
General .....	217
Parameters .....	223
Data management .....	232
Network .....	236
Service .....	242
<b>Troubleshooting .....</b>	<b>243</b>
Patient movement messages .....	243
CO2 messages .....	245
RRa messages .....	246
NIBP messages .....	247
SpO2 and SpHb messages .....	248
Temperature messages .....	249
ECG messages .....	250
Weight scale messages .....	252
Physical assessment instrument handles .....	252
Patient data management messages .....	253
Communications module messages .....	254
Radio messages .....	254
Ethernet messages .....	255
USB and USB flash drive messages .....	255
System messages .....	255
Battery power manager messages .....	256
Configuration Manager messages .....	256
Printer messages .....	257
Network messages .....	258
Problems and solutions .....	258
Lead-quality problems .....	259
Analysis errors .....	261
<b>Specifications .....</b>	<b>263</b>
Physical specifications .....	263
Environmental specifications .....	283
Device radio .....	283
Configuration options .....	285
<b>Standards and compliance .....</b>	<b>287</b>
General compliance and standards .....	287
General radio compliance .....	288
<b>Guidance and manufacturer's declaration .....</b>	<b>295</b>
EMC compliance .....	295
Emissions and immunity information .....	296
<b>Appendix .....</b>	<b>297</b>
Approved accessories .....	297
Warranty .....	310

# Introduction

---

This instructions for use (IFU) covers the following devices:

- the Connex® Vital Signs Monitor 6000 Series (Connex VSM or VSM 6000 series)
- the Connex® Integrated Wall System (Connex IWS)

Most of the content in this instructions for use applies to both Connex devices, but some sections present device-specific content. See section titles and parentheses throughout to identify the device-specific content. If your Connex device has an ECG module, see the ECG module IFU for additional instructions regarding its use.

## Connex Vital Signs Monitor 6000 Series

This instructions for use describes the capabilities and operation of the monitor. The information, including the illustrations, covers all configuration options. If your monitor configuration lacks any of these options, some information in this manual might not apply.

Before using the monitor, you must familiarize yourself with all warnings and cautions, with the steps to power up the monitor, and with the sections of this instructions for use that pertain to your use of the monitor. You must also familiarize yourself with all information that accompanies the accessories you use.



**NOTE** Some product features described in this publication might not be available in your country. For the latest information about products and features, contact Hillrom Technical Support.

## Connex Integrated Wall System

The Welch Allyn Connex Integrated Wall System combines the advanced, easy-to-use monitor capabilities of the Welch Allyn Connex Vital Signs Monitor 6000 Series with the Welch Allyn 767 Power Handles. This manual (instructions for use) is designed to help you understand the capabilities and operation of the wall system. The information in this manual, including the illustrations, is based on a wall system configured with non-invasive blood pressure (NIBP), body temperature, pulse oximetry (SpO<sub>2</sub>), total hemoglobin concentration (SpHb), pulse rate, ECG, weight scale, and two power handles. If your wall system configuration lacks any of these options, some information in this manual may not apply.

Before using the wall system, read the sections of the manual that pertain to your use of the system.



**NOTE** Throughout this instructions for use, the Integrated Wall System may be referred to as a wall system or monitor.



**NOTE** Some product features described in this publication might not be available in your country. For the latest information about products and features, please contact Hillrom Technical Support.

## Indications for use

The Connex VSM 6000 series of monitors is intended to be used by clinicians and medically qualified personnel for monitoring of neonatal, pediatric, and adult patients for

- noninvasive blood pressure (NIBP)
- pulse rate (PR)
- noninvasive functional oxygen saturation of arteriolar hemoglobin (SpO<sub>2</sub>)
- body temperature in normal and axillary modes

The most likely locations for patients to be monitored are general medical and surgical floors, general hospital, and alternate care environments. Monitoring can be accomplished on the VSM 6000 series bedside monitor itself, and the VSM 6000 series bedside monitor also can transmit data continuously for secondary remote viewing and alarming (e.g., at a central station). Secondary remote viewing and alarming features are intended to supplement and not replace any patient bedside monitoring procedures.

The optional Masimo rainbow® SET Pulse CO-Oximeter™ and accessories are indicated for the continuous noninvasive monitoring of functional oxygen saturation of arterial hemoglobin (SpO<sub>2</sub>), pulse rate (PR), total hemoglobin concentration (SpHb®), and/or respiration rate (RRa™). The Masimo rainbow SET Radical-7R™ Pulse CO-Oximeter and accessories are indicated for use with adult, pediatric, and neonatal patients during both motion and no-motion conditions, and for patients who are well or poorly perfused in hospitals and hospital-type facilities.

The optional Oridion® module and accessories are intended for the continuous noninvasive measurement and monitoring of carbon dioxide concentration of the expired and inspired breath (etCO<sub>2</sub> and FiCO<sub>2</sub>) and respiration rate (RR). It is intended for use with neonatal, pediatric, and adult patients in hospitals and hospital-type facilities.

The optional Oridion module also provides the clinician with an Integrated Pulmonary Index™ (IPI). The IPI is based on four parameters provided by the monitor: end-tidal carbon dioxide (etCO<sub>2</sub>), respiration rate (RR), oxygen saturation (SpO<sub>2</sub>), and pulse rate (PR). The IPI is a single index of an adult or pediatric patient's ventilatory status displayed on a scale of 1–10, where 10 indicates optimal pulmonary status. IPI monitoring displays a single value that represents the patient's pulmonary parameters and alerts clinicians to changes in the patient's pulmonary status.

The IPI is an adjunct to, and is not intended to replace, vital signs monitoring.

Optional compatible weight scales (e.g., Health o meter®) can be used for height, weight, and BMI input.

The optional EarlySense® (Everon) System is intended for continuous measurement of respiration rate, heart rate, and movement in an automatic contact-less manner, in a hospital or clinic setting. The system is indicated for use in children, adolescents, and adults. The operation of the EarlySense has been studied in children (weight ≥ 10 Kg) and adults (weight <111 Kg) during sleep and resting condition.

The Welch Allyn ECG/Impedance Respiration module and associated software acquires and analyzes ECG signals from patients. Patients are people with coronary problems, suspected coronary problems, or recent medical procedures that require cardiac monitoring.



This ECG module can be used on adult and pediatric patients.

The ECG module is indicated for use by healthcare professionals whenever there is a need to monitor a patient's physiological parameters for the following:

- ECG
- ECG with alarms for ventricular tachycardia, ventricular fibrillation, and asystole
- Impedance respiration

This product is available for sale only upon the order of a physician or licensed healthcare professional.

## Handle module assembly (Integrated Wall System only)

Handles supply power to Welch Allyn 3.5V instruments.

## Contraindications

This system (all configurations) is not intended to be used:

- on patients connected to heart/lung machines
- on patients being transported outside a healthcare facility
- within the controlled access area of MRI equipment
- in a hyperbaric chamber
- in the presence of flammable anesthetics

For contraindications of SpO<sub>2</sub> and SpHb sensors, consult the sensor manufacturer's instructions for use.

Systems configured with EarlySense are not intended to be used:

- on patients for whom proper positioning cannot be achieved or maintained
- on patients who do not meet the weight limits tested or specified



## Symbols

---

For information on the origin of these symbols, see the Welch Allyn symbols glossary: <https://www.hillrom.com/content/dam/hillrom-aem/us/en/sap-documents/LIT/80022/80022945LITPDF.pdf>.

### Documentation symbols



**WARNING** The warning statements in this manual identify conditions or practices that could lead to illness, injury, or death.



**CAUTION** The caution statements in this manual identify conditions or practices that could result in damage to the equipment or other property, or loss of data. This definition applies to both yellow and black and white symbols.



**WARNING** Hot surface. Do not touch.



Follow the operating instructions for use (IFU) — mandatory action.

A copy of the IFU is available on this website.

A printed copy of the IFU can be ordered from Hillrom for delivery within 7 days.

### Power symbols













Power on/Display power-saving  
[recent models]









Equipotential terminal







Power on/Display power-saving  
[older models]





















	(on the display) monitor is plugged into Alternating Current power		Battery absent or faulty
	(on the monitor, green indicator) Alternating Current power present, battery fully charged		Battery charge level
	(on the monitor, amber indicator) Alternating Current power present, battery is charging		Battery cover
	Alternating Current (AC)		Rechargeable battery
	Li-ion battery		AC input power

## Connectivity symbols

	USB		Ethernet RJ-45
	Wireless signal strength <ul style="list-style-type: none"> <li>• Best (4 bars)</li> <li>• Good (3 bars)</li> <li>• Fair (2 bars)</li> <li>• Weak (1 bar)</li> <li>• No signal (no bars)</li> <li>• No connection (blank)</li> </ul>		Nurse call [recent models]
			Nurse call [older models]
	Connected to central station		Disconnected from central station

## Miscellaneous symbols

	CO2 sampling input		CO2 sampling output/exhaust
	Manufacturer		Limited rotation/Turn completely to right

	Reorder number		Serial number
	Do not reuse		China RoHS markings for control of pollution caused by electronic information products. XX indicates Environmentally Friendly Use Period in years.
	Nonionizing electromagnetic radiation		Recycle the product separate from other disposables
	Restrictions for use of wireless device in Europe. European Community's Class 2 radio equipment.		Call for maintenance
	Defibrillation-proof Type BF applied parts		Defibrillation-proof Type CF applied parts
	Atmospheric pressure limitation		Not for injection
	Transport and storage temperature range		Authorized Representative of the European Community
	Maximum safe working load limits (specific values presented with symbol)		Mass in kilograms (kg)
	Recycle		IP = International Protection Marking X = No object ingress rating 2 = Protected against vertically falling water drops when enclosure tilted up to 15°
			Degree of protection provided by the enclosure with respect to harmful ingress of liquids
	Do not expose to open flame		Product Identifier



## Screen elements

### Global navigation, controls, and indicators



Select option



Process indicator for activities like acquiring measurements and connecting to a central station

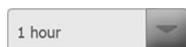

Select item from list



Display lock/unlock



Increase or decrease value

### Monitoring and connectivity



Connect to the central station and retain patient data (Monitor tab)



Disconnect from the central station but continue monitoring and retain patient data (Monitor tab)



Connected to the central station (Device Status area)



Disconnected from the central station (Device Status area)

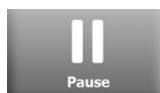

Temporarily pause continuous monitoring but retain patient data



End continuous monitoring session for current patient and clear patient data

**ECG, Heart rate/Pulse rate, and Impedance respiration**



ECG lead selector



Heart rate / Pulse rate



Beats per minute (to represent heart rate / pulse rate)



Saved waveform icon (Review tab)



Saved waveform icon, alarm condition (Review tab)



Waveform snapshot button

**NIBP**



NIBP start



NIBP stop



Intervals status indicators



NIBP view toggle

**Temperature**



Temperature site control



Direct mode selector

**SpO2 and Pulse rate**



Pulse amplitude bar



SatSeconds timer (Nellcor feature only)



**SpO2 and Pulse rate**

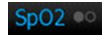

SpO2 view toggle



Response mode selector (Fast mode selected)



Beats per minute (to represent pulse rate)

**Total hemoglobin (SpHb)**



SpHbv view toggle



Averaging mode selector (Long mode selected)

**Capnography (CO2)**



CO2 pump start



CO2 pump stop



etCO2 view toggle



IPI view toggle

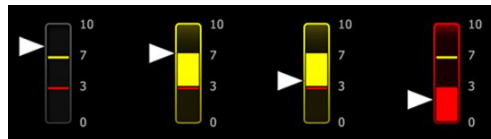

IPI graphic indicators

**RRa**



Respiration indicator



Averaging mode selector (Fast mode selected)

**Patient movement**



Bed mode



Bed exit

**Patient movement**



Patient turn indicator and timer



Bed exit (Review tab)



Patient turn indicator (Review tab)



Exit sensitivity indicator

**Manual parameters**

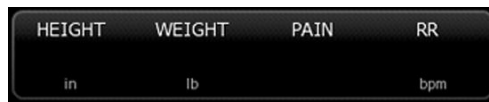

Manual parameter selector

**Alarm and information messages**

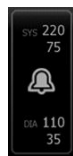

Alarm limit control



Alarm On/Off toggle



Multiple alarms toggle

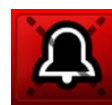

Alarm audio paused



Alarm active

















Information message







Patient Rest Mode

**Patient data management**

	Diacritical marks key (available for languages that use diacritical marks; appearance differs based on language)		Symbols key
	Send patient data		Print patient data
	View tabular trend data		View graphical trend data
	Cancel action		Add patient identifiers
	Retrieve patient list from the network		Select patient from List tab
	Delete patient from List tab		Clear patient context from Summary tab
	Forward or backward in Review tab		Proceed to the next field to input patient information

**Settings**

	Open keypad to enter Advanced settings password		Open Lost password dialog
	Save configuration settings (must be enabled in Advanced settings)		Close Advanced settings



## About warnings and cautions

---

Warning and caution statements can appear on the monitor, on the packaging, on the shipping container, or in this document.

The monitor is safe for patients and clinicians when used in accordance with the instructions and the warning and caution statements presented in this manual.

Before using the monitor, you must familiarize yourself with all warnings and cautions, with the steps to power up the monitor, and with the sections of this instructions for use that pertain to your use of the monitor. In addition to reviewing the general warnings and cautions presented in the next section, you must also review the more specific warnings and cautions appear throughout the manual in conjunction with setup/startup, device operation, patient monitoring, and maintenance tasks.

- Failure to understand and observe any warning statement in this manual could lead to patient injury, illness, or death.
- Failure to understand and observe any caution statement in this manual could lead to damage to the equipment or other property, or loss of patient data.

## General warnings and cautions



**WARNING** Many environmental variables, including patient physiology and clinical application, can affect the accuracy and performance of the monitor. Therefore, you must verify all vital signs information, especially NIBP and SpO<sub>2</sub>, before treating the patient. If there is any question about the accuracy of a measurement, verify the measurement using another clinically accepted method.



**WARNING** Inaccurate measurement risk. Do not use the device or accessories in environments affected by extremes of temperature, humidity, or altitude. See "Environmental specifications" for acceptable operating conditions.



**WARNING** Alarm limits are patient-specific. For alarms to function properly, you must set or verify alarm limits appropriate for each patient. Each time the monitor is powered on, you must check that the alarm settings are appropriate for your patient before you start monitoring.



**WARNING** The monitor is not intended for use during patient transport outside of the medical facility. Do not use the monitor to take measurements on any patient in transit.



**WARNING** Do not use the monitor as an apnea monitor. Neither the VSM 6000 series monitors, nor any of the integrated or accessory sensor systems used in conjunction with the VSM 6000 series monitors, are intended for use in apnea monitoring.



**WARNING** Use only Welch Allyn approved accessories, and use them according to the manufacturer's instructions for use. Using unapproved accessories with the monitor can affect patient and operator safety and can compromise product performance and accuracy.



**WARNING** Inaccurate measurement risk. Do not connect more than one patient to a monitor.



**WARNING** Inaccurate measurement risk. Dust and particle ingress can affect the accuracy of blood pressure measurements. Use the monitor in clean environments to ensure measurement accuracy. If you notice dust or lint build-up on the monitor's vent openings, have the monitor inspected and cleaned by a qualified service technician.



**WARNING** Inaccurate measurement risk. Liquids and excessive moisture can damage patient sensors and cause them to perform inaccurately or fail.



**WARNING** Patient harm risk. Always remove sensors from patients and disconnect them completely from monitors before bathing.



**WARNING** Liquids can damage electronics inside the monitor. Prevent liquids from spilling on the monitor.

If liquids are spilled on the monitor:

1. Power down the monitor.
2. Disconnect the power plug.
3. Remove battery pack from the monitor.
4. Dry off excess liquid from the monitor.



**NOTE** If liquids possibly entered the monitor, remove the monitor from use until it has been properly dried, inspected, and tested by qualified service personnel.

5. Reinstall battery pack.
6. Power on the monitor and verify that the monitor functions normally before using it.

If liquids enter the printer housing:

1. Power down the monitor.
2. Disconnect the power plug.
3. Remove battery pack from the monitor.
4. Remove and discard the paper roll.
5. Clean and dry the inside of the printer housing.



**NOTE** The printer housing has a drain tube that directs liquids down and out the bottom of the monitor. If liquids possibly entered other openings in the monitor, remove the monitor from use until it has been properly dried, inspected, and tested by qualified service personnel.

6. Install a new roll of paper.
7. Power on the monitor and verify that the monitor functions normally before using it.



**WARNING** Safety risk and potential shock hazard. Cords, cables, and accessories damaged from prior misuse can affect patient and operator safety. Inspect all cords, cables, and accessories for strain relief wear, fraying, or other damage according to the recommendations presented in the Maintenance and service section of this manual. Replace as necessary. Inspect the AC cord for exposed copper before touching the cord. Unplug the AC cord only by pulling on the plug, never the cord. Never lift the monitor by the power cord or patient connections.



**WARNING** Fire and explosion hazard. Do not operate the monitor in the presence of a flammable anesthetic mixture with air, oxygen, or nitrous oxide; in oxygen-enriched environments; or in any other potentially explosive environment.



**WARNING** Fire and shock hazard. Only connect LAN cables contained within the perimeter of a single building. Conductive LAN cables spanning multiple buildings may introduce fire or shock hazards unless they are fitted with fiber optic cables, lightning arrestors, or other applicable safety features.



**WARNING** The monitor may not function properly if dropped or damaged. Protect it from severe impact and shock. Do not use the monitor if you notice any signs of damage. Qualified service personnel must check any monitor that is dropped or damaged for proper operation before putting the monitor back into use.



**WARNING** Defective batteries can damage the monitor. If the battery shows any signs of damage or cracking, it must be replaced immediately and only with a battery approved by Welch Allyn.



**WARNING** Improper disposal of batteries may create an explosion or contamination hazard. Never dispose of batteries in refuse containers. Always recycle batteries according to local regulations.



**WARNING** Electric shock hazard. Do not open the monitor or attempt repairs. The monitor has no user-serviceable internal parts. Only perform routine cleaning and maintenance procedures specifically described in this manual. Never perform maintenance or service tasks while the device is connected to a patient. Inspection and servicing of internal parts shall only be performed by qualified service personnel.



**WARNING** Electric shock hazard. Never perform maintenance or service tasks while the device is connected to a patient.



**WARNING** Inaccurate measurement risk. Do not expose to temperatures higher than 122 °F (50 °C).



**WARNING** Inaccurate measurement risk. Do not use the monitor on patients who are on heart-lung machines.



**WARNING** Inaccurate measurement risk. If using patient sensors during full body irradiation, keep the sensor out of the irradiation field. If the sensor is exposed to the irradiation, the reading might be inaccurate or the monitor might read zero during the active irradiation period.



**WARNING** Inaccurate measurement risk. Do not use the monitor on patients who are experiencing convulsions or tremors.



**WARNING** Use the monitor only as described in this instructions for use. Do not use the monitor on patients as described in the Contraindications.



**WARNING** Personal/patient injury risk. Wall-mounted equipment and accessories must be installed in accordance with accompanying instructions. Improper installation can result in the monitor falling off the wall and injuring someone. Welch Allyn is not responsible for the integrity of any installation not performed by authorized Welch Allyn service personnel. Contact an authorized Welch Allyn service representative or other qualified service personnel to ensure professional installation for safety and reliability of any mounting accessory.



**WARNING** Do not place the monitor in any position that might cause it to fall on the patient.



**WARNING** Welch Allyn is not responsible for the integrity of a facility's power. If the integrity of a facility's power or protective earth conductor is in doubt, always operate the monitor on battery power alone when it is attached to a patient.



**WARNING** Avoid continuously monitoring a patient when the device is operating on battery power. If only battery power is available, you must remain in the room with any patient whose vital signs are being monitored continuously. Actively monitor both patient and battery status to ensure patient safety.



**WARNING** Patient harm and equipment damage risk. Carefully route patient cabling to reduce the possibility of patient entanglement or strangulation. When transporting the monitor on a mobile stand, properly secure all patient cables and cords to keep them clear of the wheels and to minimize trip hazards.



**WARNING** For operator and patient safety, peripheral equipment and accessories that can come in direct patient contact must comply with all applicable safety, EMC, and regulatory requirements.



**WARNING** All signal input and output (I/O) connectors are intended for connection of only devices complying with IEC 60601-1, or other IEC standards (for example, IEC 60950), as applicable to the monitor. Connecting additional devices to the monitor may increase chassis or patient leakage currents. To maintain operator and patient safety, consider the requirements of IEC 60601-1. Measure the leakage currents to confirm that no electric shock hazard exists.



**WARNING** Equipment failure and patient harm risk. Do not cover the air intake or exhaust vents on the rear and base of the monitor. Covering these vents could cause overheating of the monitor or muffling of alarms.



**WARNING** Cross-contamination or nosocomial infection risk. Clean and disinfect the monitor on a routine basis according to your facility's protocols and standards or local regulations. Thorough hand-washing before and after contact with patients greatly reduces the risk of cross-contamination and nosocomial infection.



**WARNING** For patient safety, do not use the monitor or any accessory during MRI scanning. Induced current could cause burns.



**WARNING** When the monitor is not connected to a secondary alarm system during continuous monitoring, check the monitor regularly to receive patient data, alarms, and alerts.



**WARNING** Patient safety risk. The EarlySense system is not intended for high-risk patients in coronary or respiratory distress who require continuous monitoring of heart function or CO<sub>2</sub>. For these patients, the most reliable method of patient monitoring involves close personal surveillance and/or equipment suited to that type of monitoring.





**WARNING** Patient injury risk. The decision to use the NIBP module on pregnant or pre-eclamptic patients is at the discretion of the trained clinician using the equipment.



**WARNING** Patient injury risk: The decision to use this device with children, or pregnant or nursing women is at the discretion of the trained clinician using the equipment.



**WARNING** Personal injury risk. The power cord is the disconnect device to isolate this equipment from supply mains. Position the equipment so that it is not difficult to reach to disconnect the cord.



**WARNING** Patient injury risk. This device is suitable for use with high-frequency surgical equipment but does not provide any additional means of protection.



**WARNING** Safety risk and potential shock hazard. For accessories that use a USB cable to connect to the monitor, disconnect the USB cable from the monitor when you disconnect the accessory.



**WARNING** Personal/patient injury risk. Wall Mount must be mounted using the appropriate hardware for the type of wall structure. Your facility may need to provide the appropriate hardware needed to install for your type of wall structure.



**WARNING** Personal/patient injury risk. Only authorized Welch Allyn service personnel or a Biomedical engineer should attach or remove the device from the wall mount.



**WARNING** Personal/patient injury risk. Any modification made to a Welch Allyn mounting solution removes Welch Allyn from responsibility or liability and voids the warranty.



**WARNING** Personal/patient injury risk. Welch Allyn is not responsible for the integrity of any installation not performed by authorized Welch Allyn service personnel.



**WARNING** Personal/patient injury risk. Welch Allyn is not responsible for the integrity of any wall structure or wall mounting interface. Welch Allyn recommends that you contact your Biomedical Engineering Department or maintenance service to ensure professional installation, safety, and reliability of any mounting accessory.



**CAUTION** Position the wall mount so that the screen, controls, and connectors are accessible and support optimal and ergonomic use of the device.



**CAUTION** United States Federal law restricts this monitor to sale, distribution, or use by or on the order of a physician or licensed healthcare professional.



**CAUTION** Electromagnetic interference risk. The monitor complies with applicable domestic and international standards for electromagnetic interference. These standards are intended to minimize medical equipment electromagnetic interference. Although this monitor is not expected to present problems to other compliant equipment or be affected by other compliant devices, interference issues still may occur. As a precaution, avoid using the monitor in close proximity to other equipment. In the event that equipment interference is observed, relocate the equipment as necessary or consult manufacturer's instructions for use.



**CAUTION** Use only a Class I (grounded) AC power supply cord for powering this monitor.



**CAUTION** Do not use a long press of  to power down the monitor when it is functioning normally. You will lose patient data and configuration settings.



**CAUTION** Never move the monitor or mobile stand by pulling on any of the cords as this may cause the monitor to tip over or may damage the cord. Never pull on the power cord when removing it from the power outlet. When disconnecting the power cord, always grasp the attachment plug and not the cord. Keep the cord away from liquids, heat, and sharp edges. Replace the power cord if the strain relief or cord insulation is damaged or begins to separate from the attachment plug.



**CAUTION** Use only the Welch Allyn USB client cable to connect a laptop computer to the USB client port. Any laptop connected to the monitor must be running on a battery, a 60601-1-compliant power supply, or a 60601-1-compliant isolation transformer. While monitoring a patient, you can only charge the laptop battery if it is connected to 60601-1-compliant, isolated AC power.



**CAUTION** If the touchscreen is not responding properly, refer to the troubleshooting section. If the problem cannot be resolved, discontinue use of the monitor and contact an authorized Welch Allyn service center or qualified service personnel.



**CAUTION** Verify patient identity on the monitor after manual or barcode entry and before printing or transferring patient records.



**CAUTION** Keep the monitor outside of MRI suites and any areas marked for high magnetic or electric field strength.



**CAUTION** Do not use the Suretemp to take or monitor the patient's temperature during defibrillation or electrosurgery. This may damage the temperature probe.



**CAUTION** Before weighing a patient on any weight scale connected to the monitor, disconnect all sensors from the patient. Doing so ensures an accurate weight measurement and significantly reduces electrostatic discharges that might disrupt the monitor.

## Integrated Wall System warnings and cautions

In addition to the preceding warnings and cautions, consider the following when using the Integrated Wall System.



**WARNING** Liquids can damage electronics inside the Connex IWS. Prevent liquids from spilling on the wall system.

If liquids are spilled on the wall system:

1. Power down the wall system.
2. Disconnect the power plug.
3. Remove the wall system from the wall.
4. Remove battery pack from the wall system.
5. Dry off excess liquid from the wall system.



**NOTE** If liquids possibly entered the wall system, remove the wall system from use until it has been properly dried, inspected, and tested by qualified service personnel.

6. Reinstall battery pack.
7. Mount the wall system on the wall.
8. Power on the wall system and verify that it functions normally before using it.



**WARNING** The physical assessment instruments (handles) are designed for intermittent use. On-time should not exceed 2 minutes. Allow at least 10 minutes off-time between patients.



**CAUTION** Welch Allyn is not responsible for the integrity of any wall mounting interface. Welch Allyn recommends that you contact your Biomedical Engineering Department or maintenance service to ensure professional installation, safety, and reliability of any mounting accessory.



**CAUTION** Do not use the Suretemp to take or monitor the patient's temperature during defibrillation or electrosurgery. This may damage the temperature probe.

## ECG module warnings and cautions

In addition to the preceding warnings and cautions, consider the following when using the ECG module.



**WARNING** Liquids can damage electronics inside the ECG module. Prevent liquids from spilling on the ECG module.

If liquids are spilled on the ECG module, remove it from service. The module provides no protection against liquid ingress.



**WARNING** Do not operate the Connex device and ECG module near equipment that emits strong electromagnetic or radio-frequency signals. Electronic equipment of this type can cause electrical interference with device operation, which can distort the ECG signal and prevent accurate rhythm analysis.



**WARNING** Patient safety risk. Life-threatening arrhythmias can trigger one of two optional high alarm tones for ventricular tachycardia (V-Tach), ventricular fibrillation (V-Fib), and asystole. If you are monitoring a patient for life-threatening arrhythmias, verify the alarm tone that your facility or floor has chosen.



**WARNING** Patient injury risk. Do not perform waveform analysis on the ECG acquisition display as these ECG representations are not true to scale. Make manual measurements of ECG intervals and magnitudes on printed ECG reports only.



**WARNING** The arrhythmia analysis program is intended to detect V-Tach, V-Fib, and asystole. It is not intended to detect other arrhythmias. Occasionally it may incorrectly identify the presence or absence of an arrhythmia. Therefore a physician must analyze the arrhythmia information in conjunction with other clinical findings.



**WARNING** Arrhythmia detection (for V-Tach, V-Fib, and asystole) and impedance respiration are not intended for neonatal patients.



**WARNING** Computer-assisted ECG data acquisition and interpretation is a valuable tool when used properly. However, no automated interpretation is completely reliable and a qualified physician shall review the interpretations before treatment, or non-treatment, of any patient. The ECG module must be used in conjunction with clinical signs and symptoms. This device is only intended to be an adjunct in patient assessment. Certain arrhythmias or pacemaker signals could adversely affect heart rate indications or alarms.



**WARNING** Patient injury risk. The data captured from this device should not be used as a sole means for determining a patient's diagnosis or prescribing treatment.



**WARNING** Physiological variations in the patient population generate a nearly infinite range of possible ECG waveform morphologies. In some cases, the Connex device occasionally may not alarm or alarm inappropriately for some arrhythmia (V-Tach, V-Fib and asystole) waveforms. It is the operator's responsibility to set alarm limits as appropriate for each individual patient. High risk patients must be kept under close surveillance.



**WARNING** For patients with a pacemaker, maintain a minimum of 6 inches between the device and pacemaker. Power down the ECG module immediately and provide appropriate patient care if you suspect the ECG module has affected the pacemaker.



**WARNING** Patient safety risk. Use of impedance respiration monitoring can affect the operation of some pacemakers. Keep pacemaker patients under close observation. If pacemaker operation is affected, turn off impedance respiration.



**WARNING** Impedance respiration must be disabled when using ECG wrist clip electrodes.



**WARNING** Inaccurate measurement risk. Impedance respiration monitoring is not reliable when ECG electrodes are placed on the limbs.



**WARNING** Patient safety risk. Correctly set pacemaker detection and keep pacemaker patients under close observation. A pacemaker pulse can be counted as a QRS, which could result in an incorrect heart rate and failure to detect cardiac arrest and some life-threatening arrhythmias (V-Tach, V-Fib, and asystole). If your patient has a pacemaker, turn pacemaker detection ON to avoid this hazard.



**WARNING** Inaccurate measurement risk. When an external pacemaker is being used on a patient, arrhythmia monitoring (to detect V-Tach, V-Fib and asystole) is severely compromised due to the high energy level in the pacemaker pulse. This may result in the arrhythmia algorithm's failure to detect pacemaker non-capture or asystole.



**WARNING** Patient safety risk. Implantable pacemakers, which are minute-ventilation-rate adaptive, can occasionally interact with the impedance respiration measurement of cardiac monitors causing the pacemakers to pace at their maximum. Keep pacemaker patients under close observation.



**WARNING** Inspect device and accessories before each use. Use only Welch Allyn approved accessories. Peripheral equipment and accessories that touch the patient must comply with all appropriate safety, EMC, and regulatory requirements.



**WARNING** Frequently inspect—electrically and visually—all cables, sensors, and electrode wires. Replace any damaged cables, sensors, or wires. Failure to properly inspect and keep in excellent working order all cables, sensors, and electrode wires can result in hazards to patients and to equipment failure and damage.



**WARNING** Always keep patient motion to a minimum. Motion artifact can cause inaccurate measurement of patient vital signs.



**WARNING** The conductive parts of electrodes and associated connectors for type BF or CF applied parts, including neutral electrode, should not contact other conductive parts including earth.



**WARNING** Skin irritation may result from the continuous application of the ECG electrodes. Examine the skin for signs of irritation or inflammation and avoid placing the electrode in those areas. If you observe skin irritation, replace the electrodes or change the location of the electrodes every 24 hours.



**WARNING** Connect patient lead wires only to the patient electrodes.



**WARNING** Patient safety risk. The most important aspect of obtaining a quality electrocardiogram is a proper electrode hook-up. Failure to properly apply the electrodes and patient cable may result in noisy signal, false alarms, or sub-optimal electrocardiogram analysis, which could cause patient harm. Any of these events could potentially contribute to patient harm.



**WARNING** Patient injury risk. Use only accessories approved by Welch Allyn, including electrodes, lead wires, and patient cables. These approved accessories are required for electrical protection of the patient during cardiac defibrillation. Refer to the accessory list or [parts.hillrom.com](https://parts.hillrom.com).



**WARNING** Patient injury risk. Use only ECG cables supplied or specified by Welch Allyn. Use of any other ECG cables can negate defibrillator protection and can create a risk of patient injury due to shock.



**WARNING** To avoid serious injury or death, take precautions consistent with good clinical practice during patient defibrillation:

- Avoid contact with the electrocardiograph, patient cable, and patient.
- Place defibrillator paddles properly in relation to electrodes.



**WARNING** To avoid serious injury or death, take precautions consistent with good clinical practice during patient defibrillation:

- Before defibrillation, verify that patient leads are properly connected to the patient and the ECG module. Loose ECG leads can divert defibrillator current.
- After defibrillation, pull each patient lead out of the patient cable and inspect the tips for charring (black carbon marks). If there is any charring, the patient cable and individual leads must be replaced. If there is no charring, fully reinsert the leads into the patient cable. (Charring can occur only if a lead is not fully inserted into the patient cable before defibrillation.)



**WARNING** Electric shock hazard. Before cleaning the monitor, disconnect the AC power cord from the mains outlet and the power source.



**WARNING** This equipment must not be connected to any other equipment that is not compliant with EN60601-1. The combined leakage currents could exceed safe limits.



**WARNING** Use of accessories, transducers, and cables other than those specified may result in degraded electromagnetic compatibility performance of this device.



**WARNING** Do not operate this product with MRI (Magnetic Resonance Imaging) equipment.



**WARNING** When using ECG Wrist Clip electrodes, although a normal Lead I QRS waveform is produced on the monitor, this waveform should not be used for serious clinical interpretation because the electrodes are not properly triangulated around the patient's heart.



**WARNING** Inaccurate measurement risk. To use ECG wrist clip electrodes effectively, consider the following:

- The size of ECG wrist clip electrodes is fixed; you cannot adjust it.
- Proper orientation of the clip with the monitor depends on repositioning the clip until you achieve a snug fit.
- The preferred position of the clip is the patient's wrist, but you can move it up the patient's arm toward the torso.
- The clip might not work with patients who have small wrists and arms.
- Exercise caution when placing the clip so that it doesn't impede circulation along the patient's wrist and arm.
- If you cannot achieve a snug fit with the wrist clip, use some other method to monitor ECG.



**WARNING** Do not pause or turn off an audible alarm if the patient safety might be compromised.



**WARNING** Always ensure that the appropriate electrode placement is employed for the lead configuration selected.



**WARNING** The ECG module should not be used on patients who are linked to heart lung machines.



**WARNING** If an electrosurgical unit is used, place the ECG cable and wires as far as possible from the site of the surgery and from the electrosurgical cables. This will minimize interference and the risk of burns to the patient. Ensure that the electrosurgical return cable (neutral) is well attached and making good contact with the patient.



**WARNING** Patient injury risk. To prevent cross-contamination and the spread of infection:

- Dispose of single-patient use components (for example, electrodes) after use.
- Regularly clean and disinfect all components that come in contact with patients.
- Reprocess the device accessories (for example, patient cable, leads, and reusable electrodes) between patients.



**CAUTION** Never use acetone, ether, freon, petroleum derivatives, or other solvents to clean the ECG Module. Never immerse the ECG module or the patient cable in liquid. Never autoclave or steam clean the ECG module or the patient cable. Never pour alcohol directly on the ECG module or the patient cable, and never soak any components in alcohol. If any liquid enters the ECG module, remove the ECG module from service, and have it inspected by a qualified service person before using it again.



**CAUTION** Verify that dates on applicable accessories have not expired.



**CAUTION** Connect the USB cable to the Connex device in a manner that minimizes entangling.



**CAUTION** To prevent accidental loosening of the USB cable and the potential loss of ECG connection to the device, you must close the door and tighten the screw on the Connex Vital Signs Monitor and tighten the cable retention screw on the Connex Integrated Wall System to secure the cable in place.





## Physical design

---

### Vital Signs Monitor 6000 Series

#### Standard and extended monitors

The monitor is available in two sizes: standard and extended. The primary difference between these models is the number of parameters they support.



**NOTE** Your monitor, based on size or configuration, might not contain all parameters or features illustrated in this section.

In a standard monitor, up to two parameter modules are installed on the left side. You can tell which modules are installed based on the connectors visible on the outside of the device. The following image shows a standard monitor with pulse-oximetry and blood-pressure modules.

#### Standard monitor left side

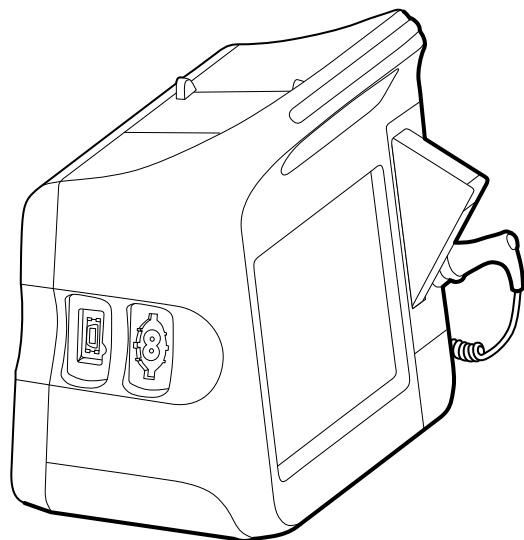

The extended version can have a maximum of three modules (such as CO<sub>2</sub>, pulse oximetry, and blood pressure) on the left side.

#### Extended monitor left side

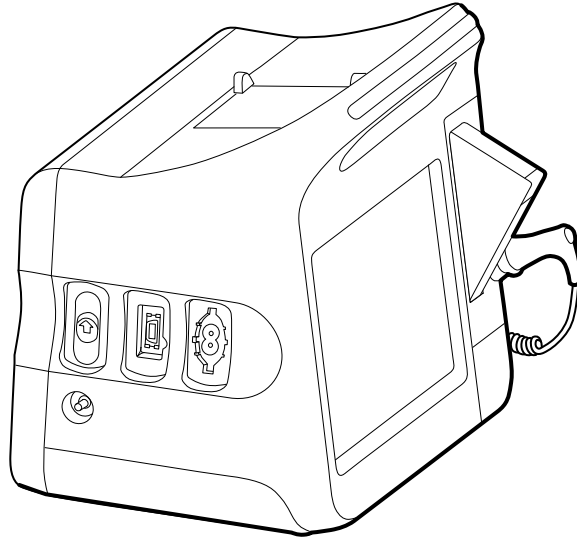

If the extended monitor is configured with EarlySense, it has an additional module on the right side.

#### Extended monitor right side

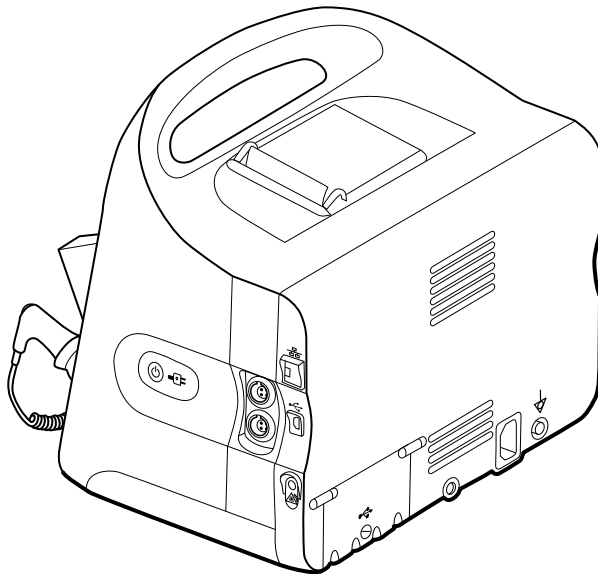



Equipment setup and basic monitor functions are the same for both models, unless otherwise noted in the instructions for use.

## Controls, indicators, and connectors

The following diagrams show a full-featured monitor. Your monitor, based on size or configuration, might not contain all of these features.

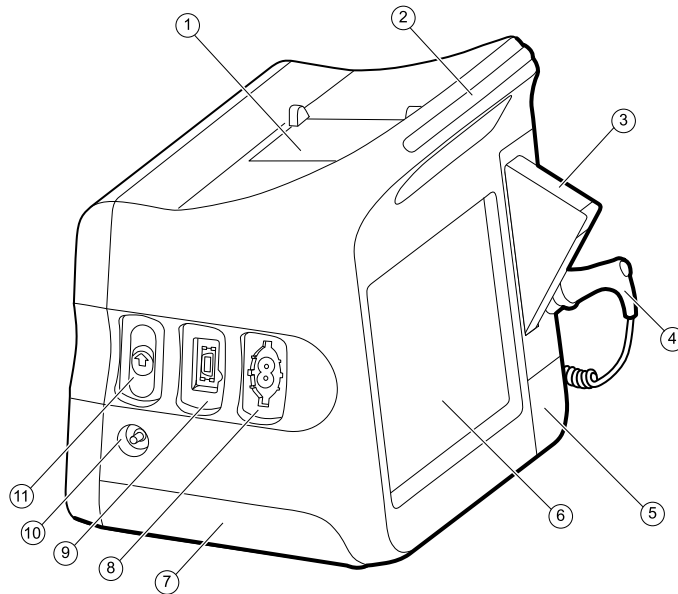
**Top-Left-Front view**



No.	Feature	Description
1	Printer	Printer provides a printout of patient and device information.
2	Light bar	Provides a visual alarm with red and amber LEDs.
3	Thermometry	Temperature probe cover box.
4	Thermometry	Temperature probe.
5	Thermometry (connector behind cover)	Secures the probe connection to the monitor.
6	LCD screen	1024 x 600 pixels color touchscreen provides a graphical user interface.
7	Battery compartment (behind cover)	Houses the lithium-ion battery.
8	Blood pressure	Supports dual-lumen or single-lumen hoses.
9	Pulse oximetry	Nellcor or Masimo rainbow SET module. The Nellcor module measures SpO2 and pulse rate. The Masimo module measures SpO2, pulse rate, SpHb, and RRa.
		 <b>NOTE</b> SpHb and RRa are optional parameters but cannot be configured together.
		 <b>NOTE</b> Monitors configured with RRa cannot be configured with CO2.
10	CO2	CO2 sampling exhaust port.

No.	Feature	Description
11	CO2	CO2 sampling input connector (behind cover).

**Right-Back-Bottom view**

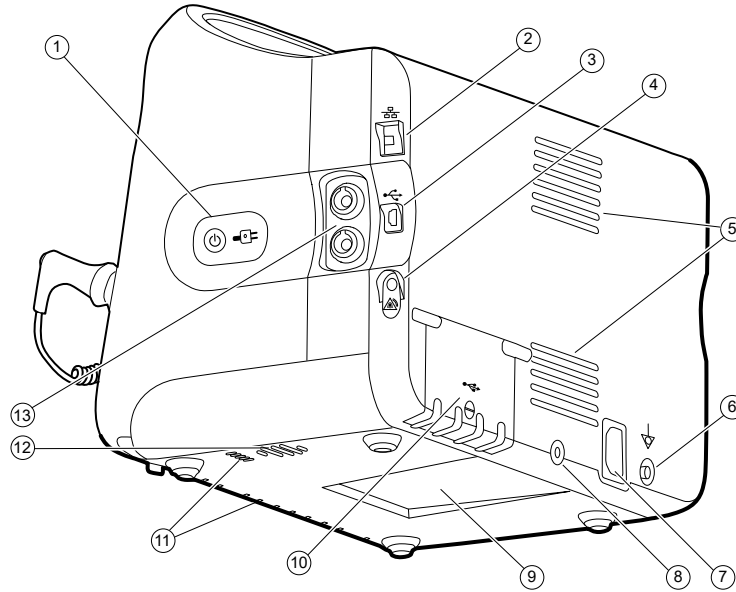

No.	Feature	Description
1	Power switch and LED	Power-on/Display power-saving button.  The LED indicates the charging status when the monitor is connected to AC power: <ul style="list-style-type: none"> <li>• Green: The battery is charged.</li> <li>• Amber: The battery is charging.</li> </ul>
2	Ethernet RJ-45	Provides a hardwired connection to the computer network.
3	USB client	Provides a connection to an external computer for testing and software upgrades.
4	Nurse call	Provides a connection to the hospital nurse call system.
5	Fan exhaust	Exhaust vents cool the monitor.
6	Ground lug (equipotential terminal)	Provided for electrical safety testing and as a means for connection of a potential-equalization conductor.
7	Power connection	Provides an external AC power connection.
8	Mobile stand mounting hardware	Secures the mounting plate to the monitor.
9	Recess for mounting plate	Secures the monitor when the monitor is mounted on the mobile stand or wall.

No.	Feature	Description
10	USB connector door	Provides access to host USB connections for optional accessories.
11	Fan intake	Fan intake vents draw in air to cool the monitor.
12	Speaker	Provides tones.
13	Patient movement	The EarlySense module monitors patient movement, respiration (RR), and pulse rate.

**NOTE** Monitors configured with RRA and CO2 cannot be configured with EarlySense.

## Integrated Wall System

### Controls, indicators, and connectors



**NOTE** Your model might not contain all of these features.

Front view

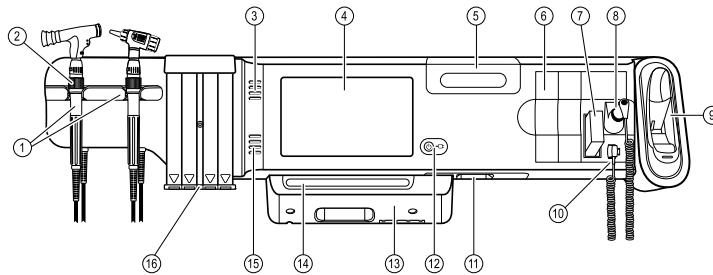

No.	Feature	Description
1	Physical assessment instruments - Handles and handle cradles	Handles will accept any 3.5V Welch Allyn instrument head. The handle cradles support using one handle at a time. A handle turns on automatically when you remove it from a cradle and turns off when you return it.
2	Rheostat	Located on each handle. Turn clockwise to increase light output; turn counterclockwise to decrease light output.
3	Exhaust vents	Exhaust vents cool the monitor.
4	LCD screen	1024 x 600 color touchscreen provides a graphical user interface.

No.	Feature	Description
5	Storage compartment	Provides covered storage for additional probe covers and other small accessories.
6	Expansion slots	Provide space to add modules.
7	SureTemp® Plus thermometer probe covers	Support temperature measurements from oral, axillary, and rectal sites.
8	SureTemp® Plus thermometer probe	Supports temperature measurements from oral, axillary, and rectal sites.
9	Braun ThermoScan® PRO thermometer and dock	Support temperature measurements from the ear. Dock charges the thermometer battery.
10	SureTemp® Plus thermometer connector	Secures the probe connection to the wall system.
11	Blood pressure and pulse oximetry	See front underside view for more detail.
12	Power switch and LED	Power-on/Standby switch. The LED indicates the charging status when connected to AC power: <ul style="list-style-type: none"> <li>• Green: The battery is charged.</li> <li>• Amber: The battery is charging.</li> </ul>
13	USB/Comms cover	Houses light bar. Provides access to host USB connections for optional accessories and some routing for cords and cables.
14	Light bar	Provides a visual alarm with red and amber LEDs.
15	Speaker	Provides tones.
16	Specula dispenser	Dispenses KleenSpec® disposable specula in pediatric (2.75 mm) and adult (4.25 mm) sizes.

### Front underside views

(Left: USB/Comms cover attached; Right: USB/Comms cover removed)

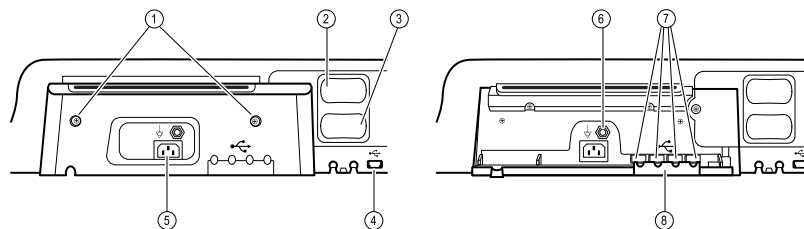

1	Retention screws	Supports removing and attaching USB/Comms cover.
2	Blood pressure	Self-contained module for easy replacement. Supports dual-lumen or single-lumen hoses.

No.	Feature	Description
3	Pulse oximetry	Optional Nellcor (SpO2) or Masimo Rainbow SET (SpO2 or combined SpO2/SpHb) in a self-contained module for easy replacement.
4	USB-to-computer connector	Provides a connection to an external computer for testing, data transfer, and software upgrades.
5	Power connection	Provides an external AC power connection.
6	Ground lug (equipotential terminal)	Supports electrical safety testing; terminal for connecting a potential equalization conductor.
7	USB connectors	Provides access to host USB connections for optional accessories.
8	USB cable retainer	Reduces strain on USB cables and connectors; helps prevent cables from disconnecting.

**Back view**

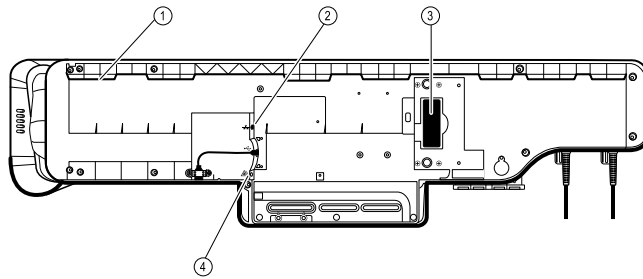

1	Recess for mounting bracket	Secures the monitor when mounted on the wall.
2	Ethernet RJ-45	Provides a hardwired connection to the computer network.
3	Li-ion battery	Provides backup power to wall system.
4	Nurse call	Provides a connection to the hospital nurse call system.

**Accessory bin**

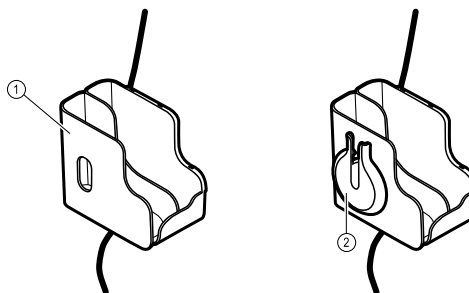

1	Accessory bin	Stores accessories and organizes cables.
---	---------------	--

No.	Feature	Description
2	SpO2 holder	Provides location to wrap SpO2 cable and attach SpO2 finger clip.

**Mounting materials**

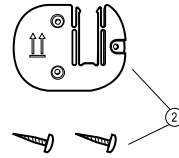
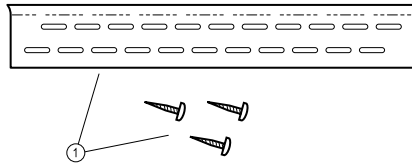

1	Wall mounting rail bracket and hardware	Secures the wall system to the wall.
2	Accessory bin mounting bracket and hardware	Secures accessory bin to the wall and provides routing and strain relief for power cord.



## Setup

---

### Vital Signs Monitor 6000 Series

#### Supplies and accessories

For a list of all approved supplies and accessories, see *Approved accessories* in the Appendix.

#### Insert the battery

This procedure applies to first-time setup of the monitor.



**WARNING** Risk of fire, explosion, and burns. Do not short-circuit, crush, incinerate, or disassemble the battery pack.

1. Turn the monitor upside down to access the battery cover.
2. Locate the battery cover, indicated by .
3. Insert a coin into the slot and push to open. Choose a coin that fits comfortably into the slot.

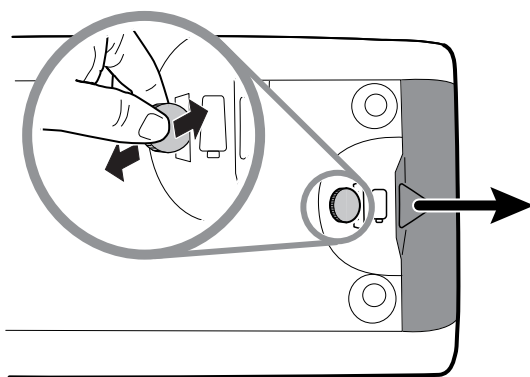

4. Slide in the battery.

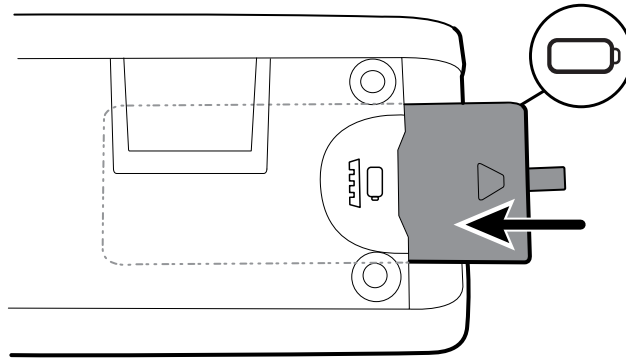

**NOTE** Do not remove the tab label from the battery. This tab helps you remove the battery from the compartment when you need to replace it.

5. Replace the battery cover by inserting one end into the notched access and then pressing firmly on the opposite end.



**NOTE** New batteries are only 30 percent charged. Therefore, connect the monitor to AC power immediately after inserting a new battery.

## Mount the monitor

You can install the monitor on a mobile stand or on an interior wall equipped with a Welch Allyn-approved wall-mount fixture.

## Check the mounting bracket

Before you mount the monitor, make sure the stand or wall-mount fixture has the mounting bracket designed for your monitor. Monitors with a standard housing require a small bracket. Monitors with an extended housing require a large bracket.

### Small bracket for standard housing

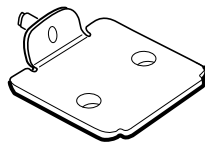

### Large bracket for extended housing

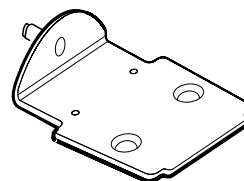

**NOTE** If your monitor has an extended housing but the small bracket is installed on your stand or wall-mount fixture, you must replace the small bracket with the large bracket. Follow the steps presented in the *Mounting Bracket Replacement Install Guide* shipped with the large bracket, and then proceed to mount the monitor.

## Mount the monitor on a stand

1. Align the monitor on the mounting bracket in the center of the stand tray. Slide the monitor into place, catching the bracket in the guides on the bottom of the monitor.
2. Ensure that the monitor is properly seated on the bracket. If you can raise either side of the monitor off the stand, it is not seated properly. Repeat step 1 until the monitor is mounted correctly.
3. Tighten the screw on the bracket into the screw hole on the back of the monitor.

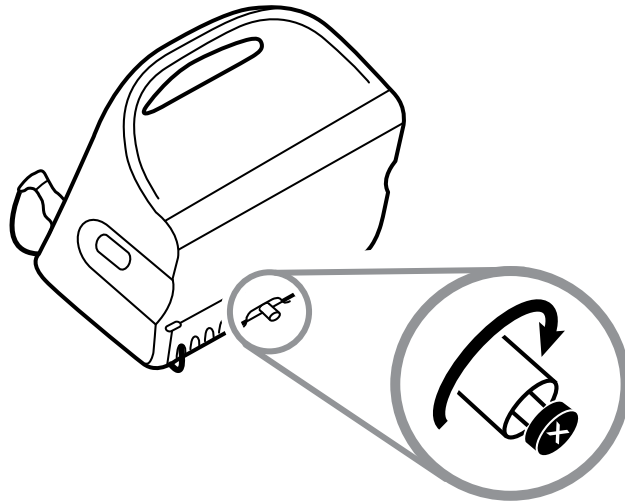

## Mount the monitor on the wall

For mounting instructions, see the wall mount manufacturer's assembly instructions.

## Attach the probe well

1. Align the probe well with the tabs facing up and down and insert the probe well into the temperature module.

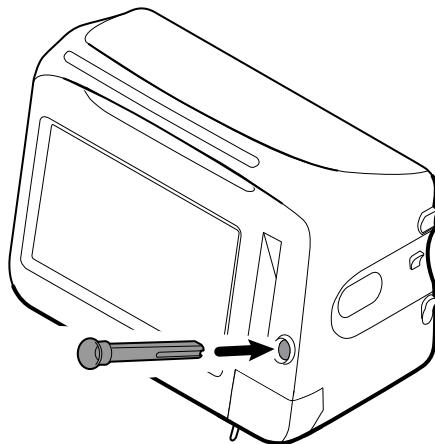

The probe well snaps into place when it is fully seated.

2. Insert the temperature probe into the probe well.

## Attach the temperature probe



**CAUTION** The temperature module only operates with the probe well properly in place.

1. Remove the cover of the temperature module by pressing the tab on the bottom and sliding the cover to the right. The cover is located at the bottom-right of the monitor, below the probe well.

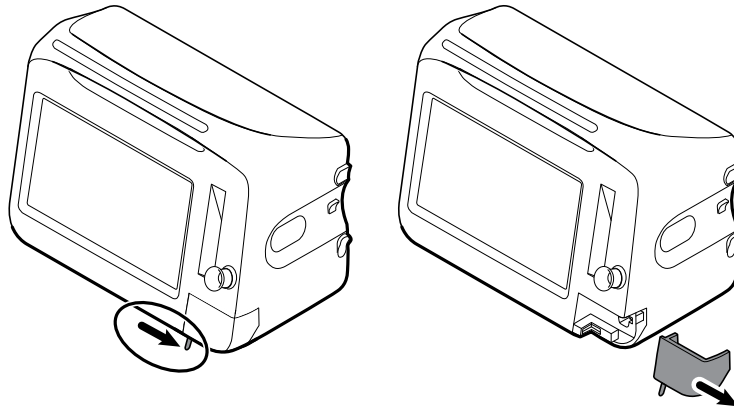

2. Hold the temperature probe cable connector with the spring tab on the right and insert it into the probe port of the temperature module.

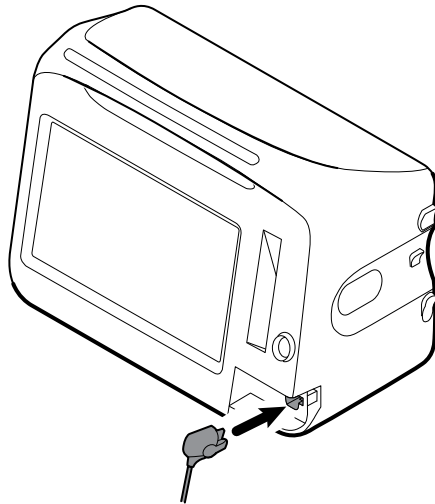

3. Push it into place until it clicks.
4. Reattach the cover. Use the alignment tab and slide the cover to the left to click it back into place.

## Remove the temperature probe and well

Follow these steps to disconnect the probe cable and remove the probe well.

1. Remove the cover of the temperature module by pressing the tab on the bottom and sliding the cover to the right. The cover is located at the bottom-right of the monitor, below the probe well.
2. Depress the spring tab on the temperature probe cable connector and withdraw it from the probe port.
3. Reattach the cover. Use the alignment tab and slide the cover to the left to click it back into place.

Grasp the probe well and pull it up to remove it from the monitor.

## Connect the NIBP hose

1. Place your thumb and forefinger on the hose connector and squeeze the side tabs.
2. Align the hose connector with the hose connector port on the side of the monitor.

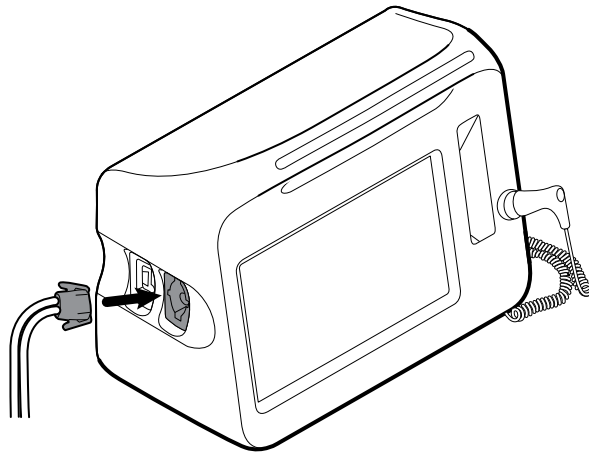

3. Insert the hose connector, pressing firmly until it clicks into place.

## Disconnect the NIBP hose

1. Place your thumb and forefinger on the hose connector.



**NOTE** Always grasp the hose by the connector. Do not pull on the hose itself.

2. Squeeze the side tabs until the connector releases.
3. Pull the connector away from the connector port.

## Connect the SpO2 cable or the SpO2/RRa dual cable



**WARNING** Patient injury risk. Do not use a damaged sensor or pulse oximetry cable or a sensor with exposed electrical or optical components.

Follow these steps to connect the SpO2 cable or the SpO2/RRa dual cable to the SpO2 port on the monitor. The location of the port on your monitor might differ from that shown in the images below.



**NOTE** For monitors configured with SpHb, the sensor used to monitor SpHb also measures SpO2.



**NOTE** SpHb and RRa cannot be configured together.

### Connect the SpO2 cable

1. Place your thumb and forefinger on the cable connector and squeeze the side tabs.

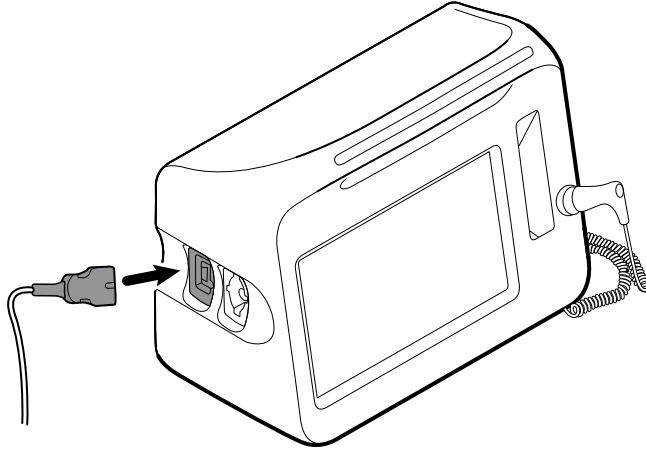

2. Align the cable connector with the cable connector port.
3. Insert the cable connector, pressing firmly until it clicks into place.

### Connect the SpO2/RRa dual cable



**NOTE** Monitors configured to measure acoustic respiration (RRa) require a dual cable as shown below. The dual cable connects to the device with one connector but splits into two separate cables at the other end to support RRa and SpO2 measurement.

1. Connect the dual cable to the device as shown in the preceding steps. (The connector is the same as for the standard SpO2 cable.)

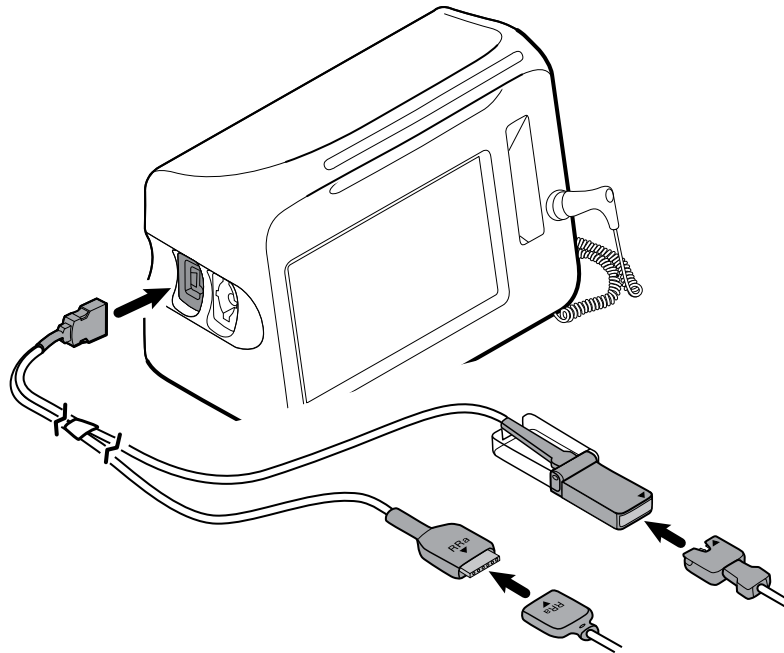

2. Align the RRA dual cable connector and the RRA acoustic respiration sensor connector so that the arrow labels point toward each other. Insert the RRA dual cable connector into the RRA sensor connector until it locks into place.
3. Open the SpO2 dual cable connector's protective cover and align the arrow on this connector with the arrow on the SpO2 sensor cable connector. Insert the SpO2 sensor cable connector into the SpO2 dual cable connector, and then close the protective cover.



**NOTE** Arrows appear on the dual connector as well as on the sensor connectors to ensure proper cable connections.



**NOTE** Typically, a clinician will connect the single-use RRA sensor to the RRA patient cable at the start of acoustic respiration monitoring. See the sensor manufacturer's instructions for use for more information. Also see the Acoustic Respiration rate (RRA) section of this instructions for use.

## Disconnect the SpO2 cable or the SpO2/RRA dual cable

1. Place your thumb and forefinger on the cable connector.



**NOTE** Always grasp the cable by the connector. Do not pull on the cable itself.

2. Squeeze the side tabs until the connector releases.
3. Pull the connector away from the connector port.

## Connect the patient movement cable

1. Align the EarlySense cable connector with one of the EarlySense ports on the right side of the monitor.

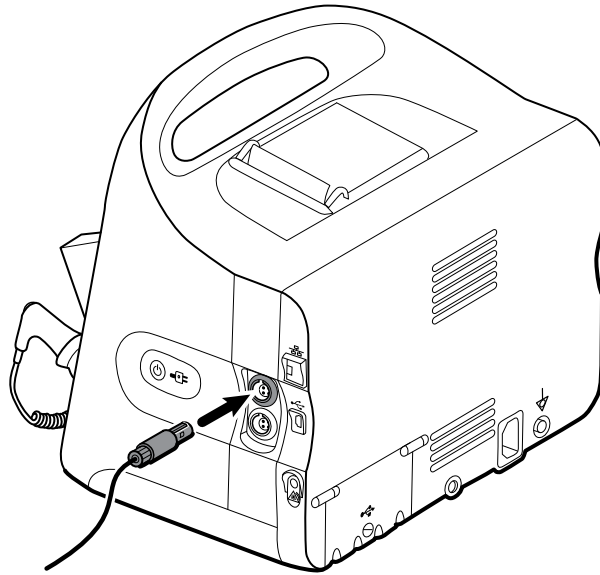

2. Insert the cable connector until it clicks into place. Also check the stress relief connector on the cable to ensure that both parts of the cable are tightly connected.
3. When you are ready to monitor a patient, position the bed sensor (sensing unit) as follows:
  - horizontally under the patient's mattress
  - the top surface of the sensing unit facing the mattress
  - the sensing unit under the patient's chest area
  - the sensing unit cable extending toward the head of the bed



**NOTE** Typically, a clinician will connect the bed sensor and cable at the start of patient movement monitoring. See the Patient movement section of this instructions for use for more information.

## Disconnect the patient movement sensor and cable

To disconnect the EarlySense bed sensor, pull the sensor cable connector out of the cable connector port on the device.

## Attach a USB accessory



**CAUTION** Accessories attached to this monitor must run on battery power. Do not use any accessory's external power supply when it is attached to the monitor.

1. On the rear of the monitor, loosen the screw on the USB door and open it.



**NOTE** On some monitor stands, the monitor mounting bracket partially overlaps the USB door. If you observe this overlap, loosen the screw on the monitor mounting bracket and shift the monitor forward just enough on the bracket to open the USB door, then slide the monitor back on the mounting bracket.

2. Attach each accessory's USB cable into an unused USB port on the monitor. See the accessory's instructions for use for any special instructions.





**CAUTION** Connect cables in a manner that minimizes entangling.

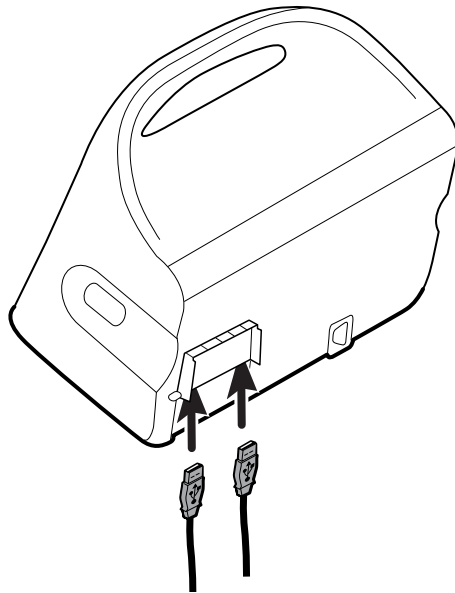

3. Close the door and tighten the screw.



**NOTE** If you loosened the monitor mounting bracket in order to open the USB door, shift the monitor forward on the bracket as you did in step 1, close the door, and then slide the monitor back into its mounted position. Ensure that the monitor is seated firmly on the bracket, then tighten the screw on the bracket into the screw hole on the back of the monitor. (See "Mount the monitor on a stand" in this section for more detail.)



**NOTE** Some accessories require a license to enable them for use. These accessories are packaged with an authorization code and instructions for activating the license using the Welch Allyn Service Tool. For more information, refer to the instructions and the service tool installation guide.

## Detach a USB accessory

1. On the rear of the monitor, loosen the screw on the USB door and open it.
2. Detach the accessory's USB cable from USB port on the monitor.
3. Close the door and tighten the screw.

## Insert a new roll of paper

The printer is located on the top of the monitor. Follow these steps to insert the roll of printer paper:

1. Grasp the two tabs on the printer door and pull up to open.
2. Insert a new roll of paper.



**NOTE** The paper roll must be installed so that it unwinds from the bottom of the roll, as illustrated. If the paper roll is not installed correctly, the printer will not print properly.

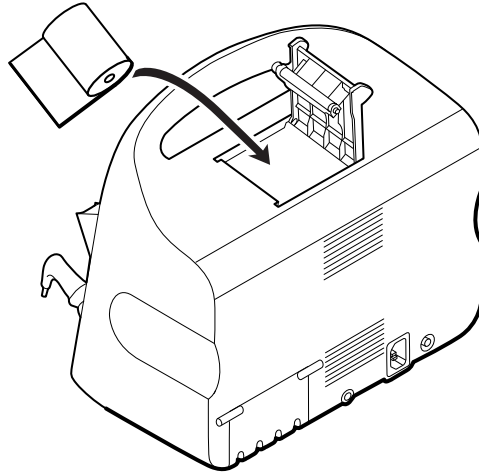

3. Advance the end of the roll past the roller so that it extends past the printer door, as shown.

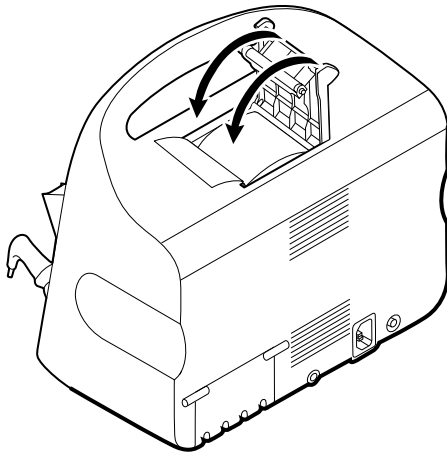

4. With one hand, pull lightly on the paper to take up any slack. With the other hand, close the printer door by pushing it down and into place until it clicks.  
Be certain that the paper does not catch in the printer door.

## Connect AC power

You can use the monitor with AC or battery power (after fully charging the battery).



**WARNING** Shock hazard. Inspect the AC cord for exposed copper before touching the cord.



**CAUTION** During continuous monitoring, keep the monitor connected to AC power at all times. If only battery power is available, you must remain in the room with any patient whose vital signs are being monitored continuously. Actively monitor both patient and battery status to ensure patient safety.

1. Insert the power cord into the AC power connector port on the back of the monitor.

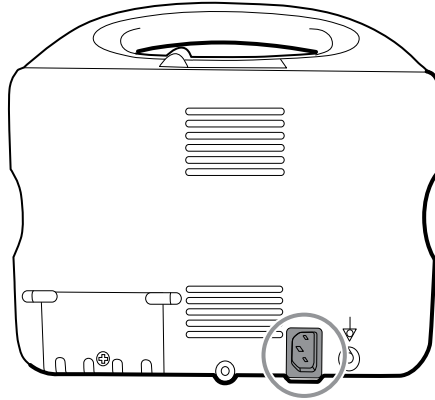

2. Insert the power plug into an electrical outlet to power the monitor and to charge the battery.

## Disconnect AC power

Carefully grasp the power plug and disconnect it from the power outlet. To avoid damaging the power cord, do not pull on the cord itself.

## Integrated Wall System



**CAUTION** Welch Allyn is not responsible for the integrity of any wall mounting interface. Welch Allyn recommends that you contact your Biomedical Engineering Department or maintenance service to ensure professional installation, safety, and reliability of any mounting accessory.

## Supplies and accessories

For a list of all approved supplies and accessories, see *Approved Accessories* in the Appendices.

## Unpack the wall system

This procedure applies to first-time setup of the wall system.



**CAUTION** You must follow these instructions exactly to ensure safety and ease of assembly.



**CAUTION** Do not remove any packing materials around the wall system until the instructions tell you to do so.

1. Lift the wall system out of the box by the cardboard handles.

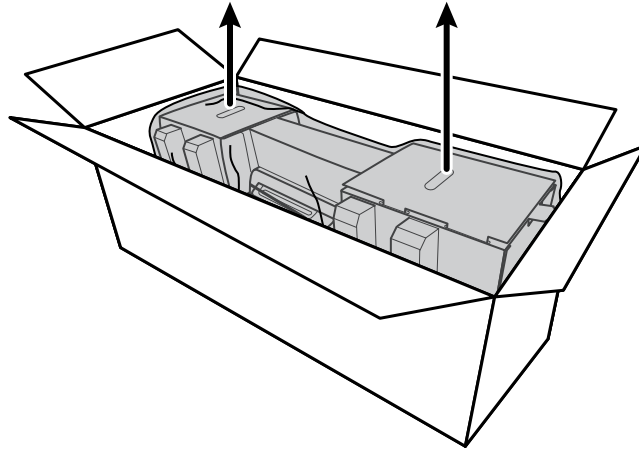

2. With the wall system still in its packing material, place it onto a table or flat work surface and remove it from the plastic bag.

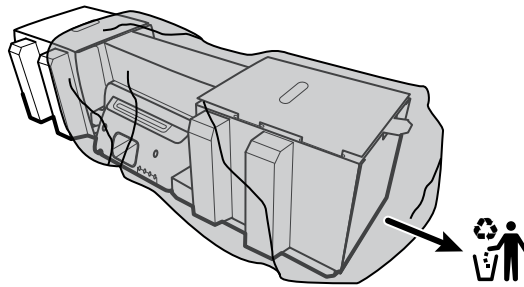

3. Turn the wall system over so that back of the wall system faces up.

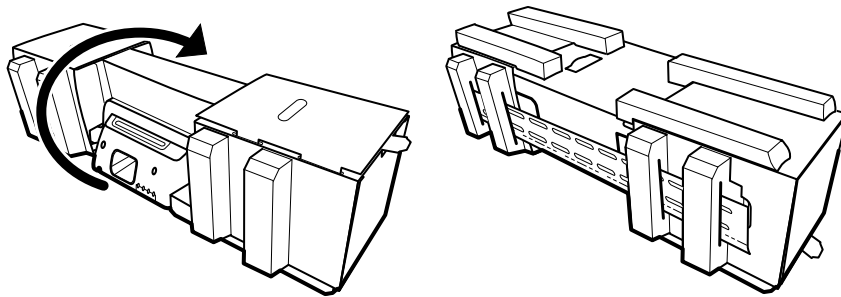

## Insert the battery

This procedure applies to first-time setup of the wall system. Therefore, the wall system is assumed to be shut down.



**WARNING** Risk of fire, explosion, and burns. Do not short-circuit, crush, incinerate, or disassemble the battery pack.

1. Locate the battery compartment, indicated by .

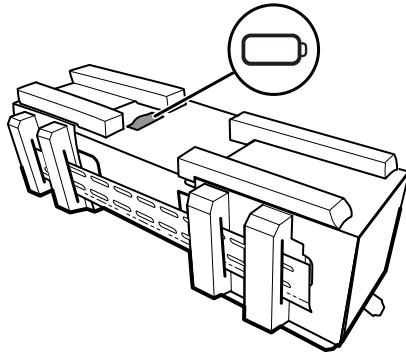

2. Insert the battery. (The battery is in a pink anti-static bag in the accessory box.)

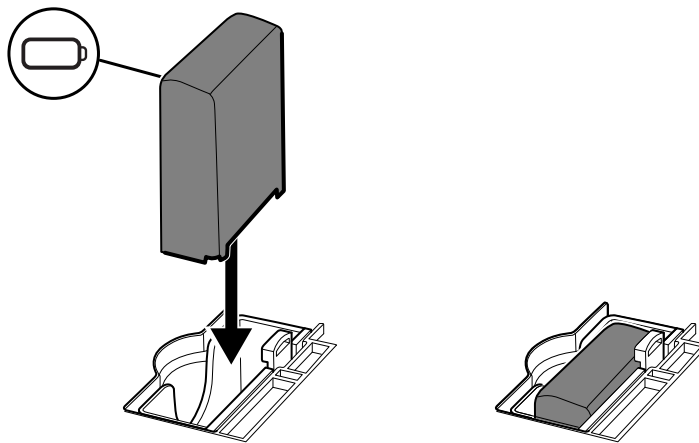

## Prepare for mounting

1. Slide the mounting rail bracket out of the packing material and put it aside. Do not discard. Then flip the wall system onto its back.

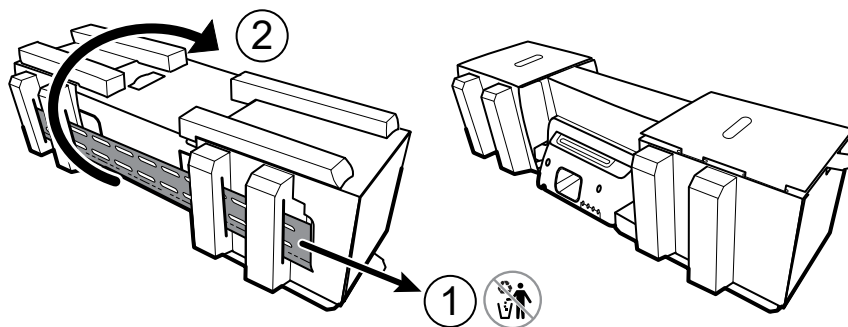

2. Remove the cardboard end caps and all foam as shown and put aside for recycling.

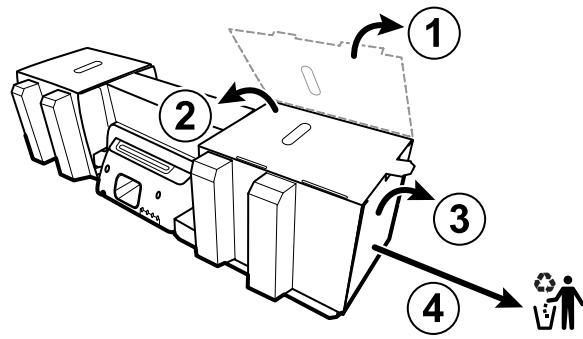

**CAUTION** Do not remove the cardboard securing the handles on the left side of the wall system at this time. The cardboard prevents damage to those instruments during the mounting process.

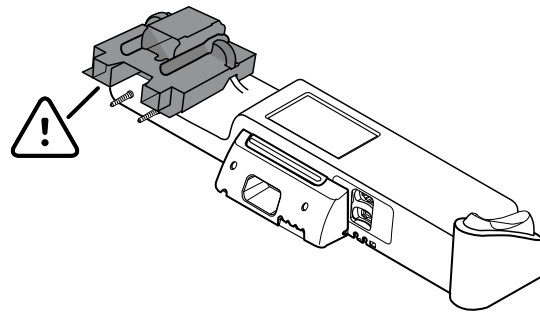

## Mounting hardware inventory

Use these items to mount the wall system.

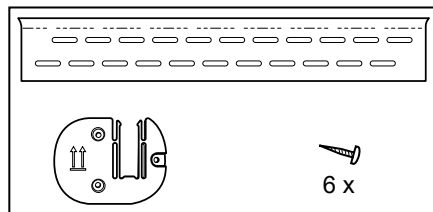

- Mounting rail bracket
- Accessory bin bracket
- Screws

## Tools list

Use these tools to mount the wall system.

- #2 Phillips screwdriver
- level
- tape measure
- stud finder
- drill
- 1/8-inch (3.17 mm) diameter drill bit

## Mounting location

Before mounting the wall system, consider the following recommendations to determine the best mounting location:

- Mount the wall system to studs.
- Mount the wall system within reach of the AC power outlet. The power cord is 8 ft. (2.44 m) long.
- Avoid brightly lit areas.
- Blood pressure tubing is 8 ft. (2.44 m) long.
- Position the wall system so that all instruments are accessible and in a location that allows for ergonomic examinations.

### Sample room layout

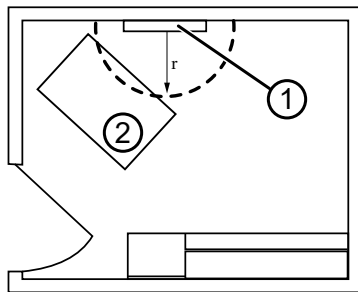

1. Connex Integrated Wall System
2. Examination table

## Mount the wall system

1. On the selected wall, find and mark the studs, and choose the system height and corresponding height for the mounting rail bracket.

**Recommendation:** Place the mounting rail bracket 63 in. (1.6 m) from the floor, which places screen center height at approximately 63 in. (1.6 m) from the floor.



**CAUTION** This drawing shows the physical relationships of the mounting brackets to each other and to the wall system **after** you complete the mounting instructions. Do not place the wall system on the wall until you have completed all preliminary steps.

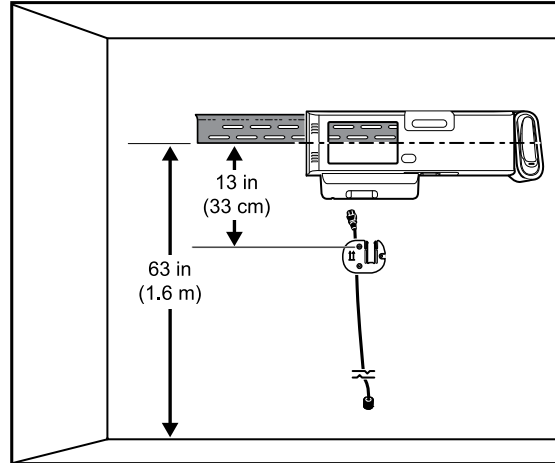

- Affix the mounting rail bracket to three studs at the selected height using the available screws (anchors are provided for additional support).



**CAUTION** Ensure that the upper "lip" of the bracket sticks out from the wall and that the bracket is level.

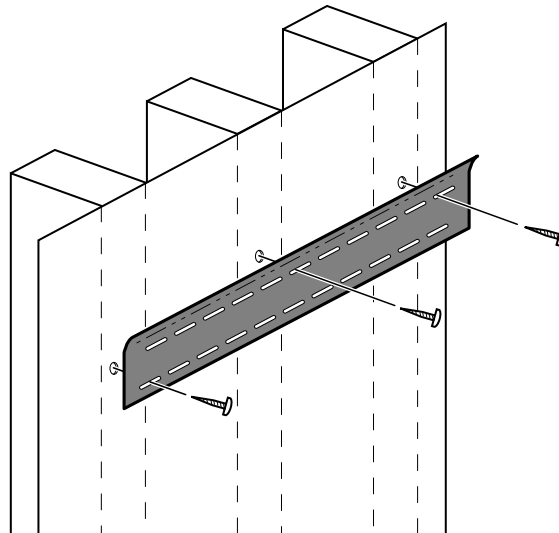

- Route the power cord through the channel in the back of the accessory bin bracket, then mount the bracket on the center stud at least 13 in. (33 cm) below the mounting rail bracket.



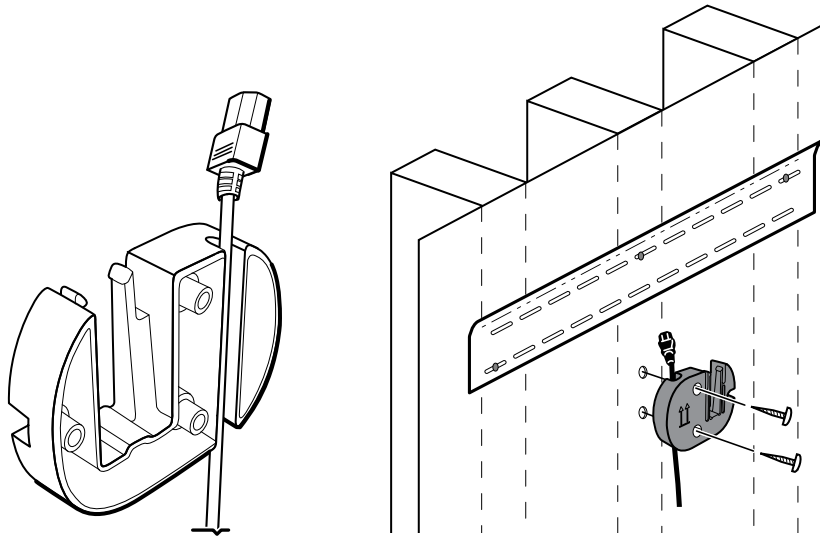

4. Before mounting the wall system, remove the cover by loosening the captive retention screws.

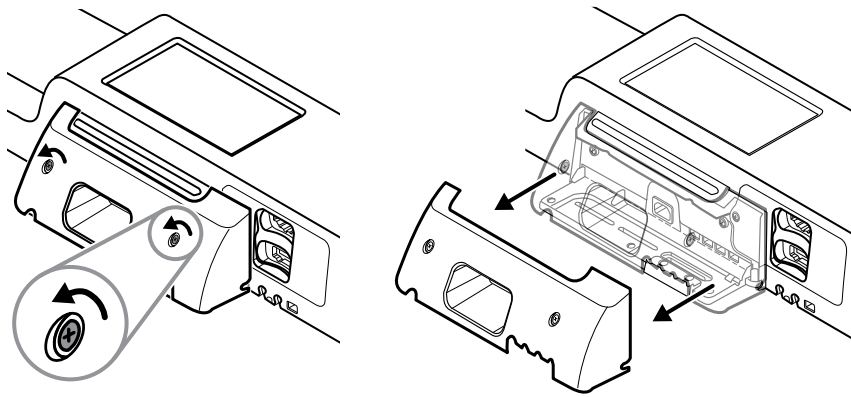

5. Hang wall system on the mounting rail bracket.



**WARNING** Ensure that the ribs on the back of the wall system fully engage the mounting rail bracket. The wall system should be level and flush to the wall.

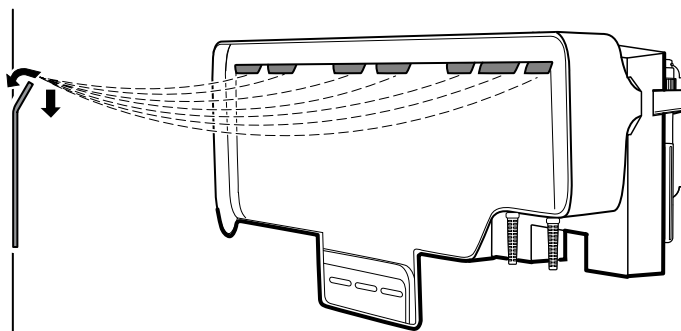

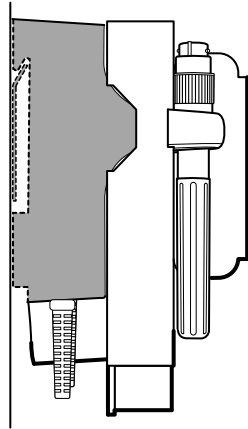

6. Select one of the three available slots at the bottom of the unit that overlaps a stud, and secure the unit to the stud with the remaining screw.



**WARNING** Failure to install this security screw may result in personal injury and equipment damage.

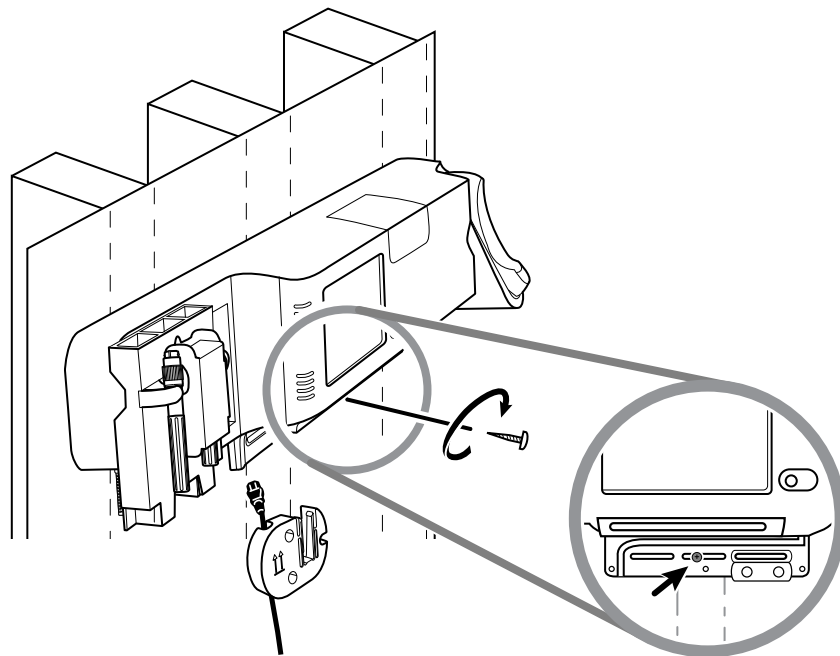

7. If the wall unit is configured for SpO<sub>2</sub> or SpHb, connect the sensor cable and route it through the channel above the security screw you just installed.

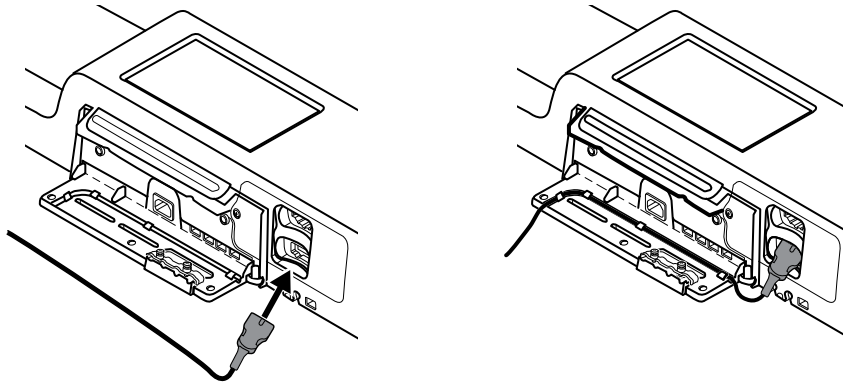

8. Re-attach the cover.
  - a. Thread the sensor cable through the cutouts on the top right and bottom left of the cover.

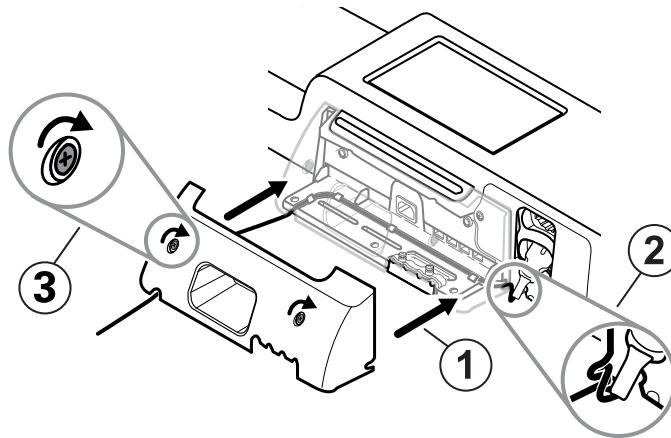

- b. Tighten the two retention screws.
9. Attach the system power cord to the wall unit. Do not plug the cord into an outlet at this time.

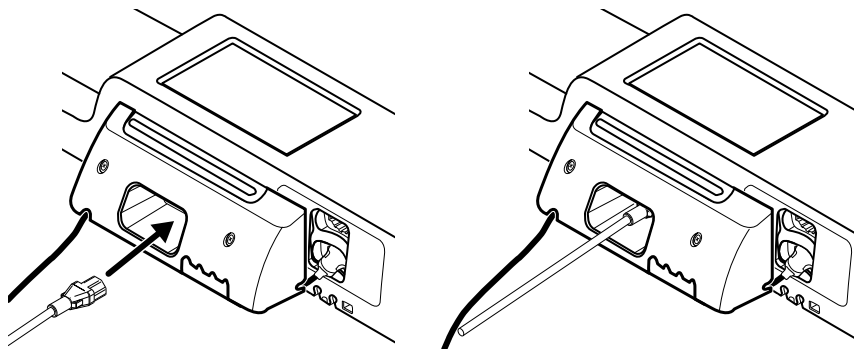

## Mount the accessory bin

1. Mount the accessory bin on the accessory bin bracket, then loosely wrap the excess power cord around the accessory bin bracket.

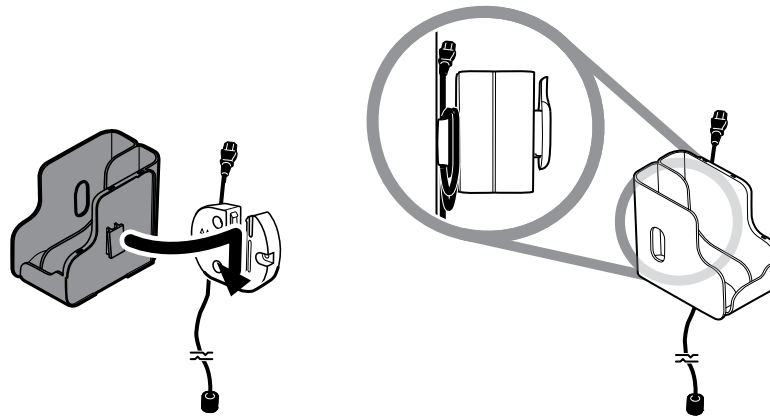

2. If your wall system is configured for SpO2 (or SpHb), attach the spool to the accessory bin by sliding the spool onto the retention clip.

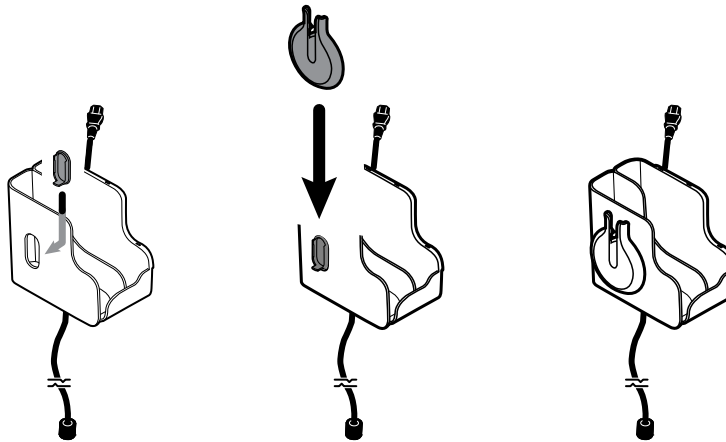

3. Properly orient and insert the sensor cable into the patient cable connector. (You just connected the opposite end of the sensor cable to the wall system.) Ensure the sensor cable is inserted completely, then close the protective cover. (See the sensor manufacturer's instructions for use.)
4. Wrap the excess patient cable around the spool, and place the finger clip in the holder. Also observe the maximum safe working load limit noted here when filling the bin.

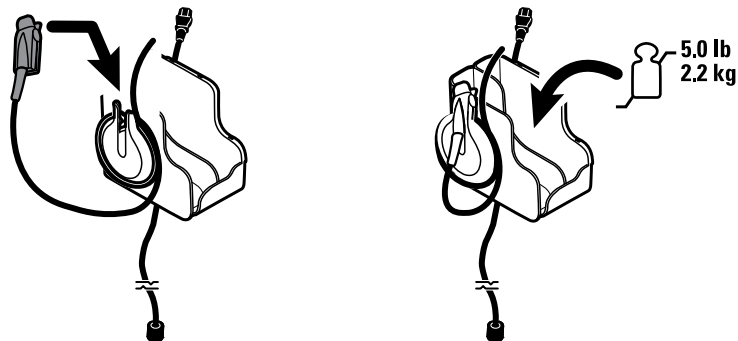

## Connect the blood pressure (NIBP) hose

1. Align the hose connector with the hose connector port on the bottom of the monitor.
2. Insert the hose connector, pressing firmly until it clicks into place.

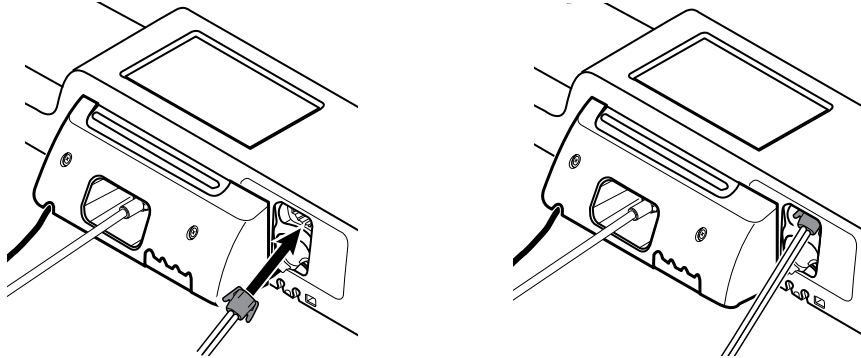

3. Attach a blood pressure cuff to the tubing (see the cuff manufacturer's instructions for use), then store the cuff in the accessory bin.

## Set up the physical assessment instrument handles and specula dispenser

1. Attach the specula dispenser. Ensure that the keyhole locking slots on the back of the dispenser engage the locking screws on the wall system, then push down firmly.

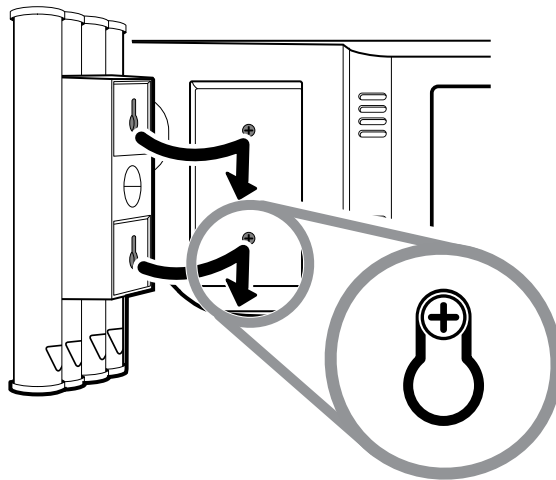

2. Remove cardboard securing instrument handles.

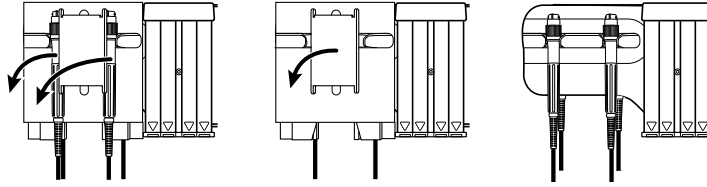

3. Attach Welch Allyn 3.5V instrument heads of your choice to the handles. See the instructions for use for each instrument head.

## Set up the SureTemp® Plus thermometer

If your wall system is configured for a SureTemp Plus thermometer, follow these setup instructions.

1. Align the probe well with the tabs facing up and down and insert the probe well into the temperature module.

The probe well snaps into place when it is fully seated.

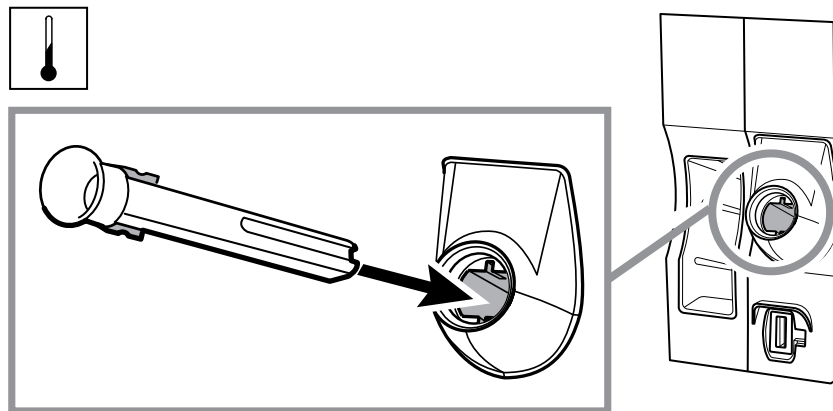

2. Hold the temperature probe cable connector with the spring tab on the right and insert it into the probe port of the temperature module. Push it into place until it clicks.

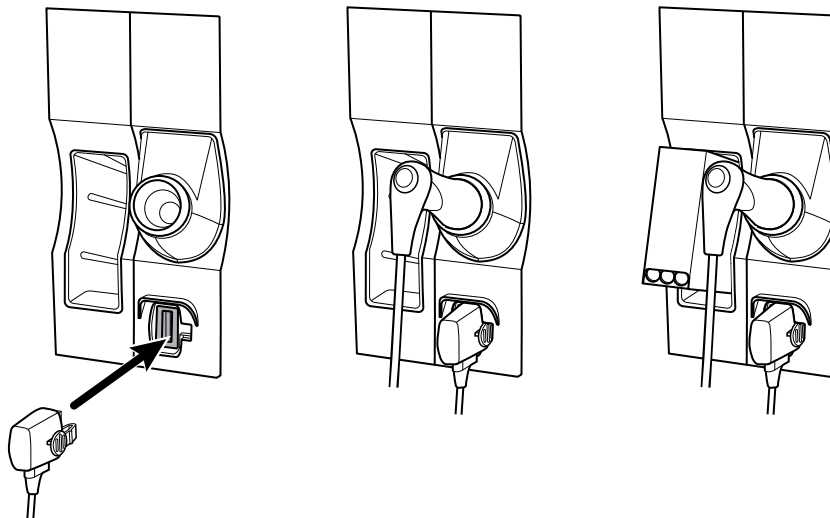

3. Insert the temperature probe into the probe well.
4. Open a box of probe covers and place it in the probe cover box holder.



**NOTE** Spare boxes of probe covers can be stored in the compartment on the top of the wall system.

## Set up the Braun ThermoScan® PRO thermometer

If your system is configured for the Braun ThermoScan thermometer, follow these setup instructions.

1. Remove the thermometer from the package. Then open a box of probe covers and place it in the dock.

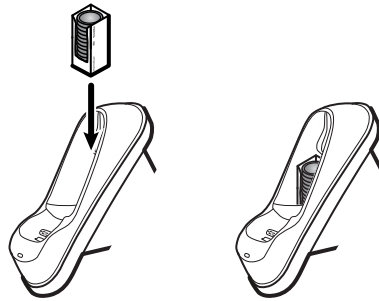
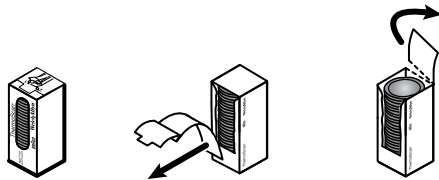

2. Remove the thermometer cover, insert the battery, replace the thermometer cover, then place the thermometer in the dock.

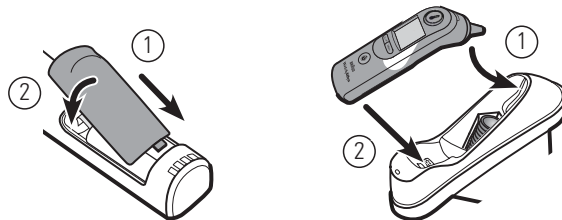
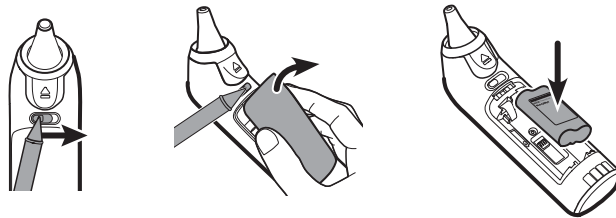

3. Charge the Braun thermometer for 24 hours before first use.
4. To switch from Celsius to Fahrenheit, see the thermometer manufacturer's instructions for use.



**NOTE** The Braun ThermoScan PRO 6000 thermometer does not charge during ECG monitoring. When ECG monitoring stops, the thermometer automatically resumes charging.



**NOTE** In monitors with an older version of the Communication module (version 4 or earlier), the Braun ThermoScan PRO 6000 thermometer does not charge during ECG monitoring. When ECG monitoring stops, the thermometer automatically resumes charging. See the **Settings > Advanced** tab to display the Communication module version in your monitor.

## Connect AC power

The wall system uses both battery and AC power. After completing all other setup activities, you can apply power to the wall system.

1. Insert the power plug into an outlet to power the monitor and to charge the battery.

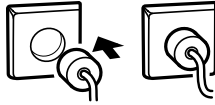

**NOTE** New batteries are only 30 percent charged. You must plug the wall system into AC power to fully charge the battery. Do not plug in the power cord until completing all preliminary steps.

2. Proceed to Startup.

## Attach an accessory

1. Shut down the wall system and detach the power cord. Then remove the cover from the wall system by loosening the captive retention screws.
2. Loosen the two screws on the cable retention clamp and remove it. Then connect the USB cable(s) to an available connector and thread the cable(s) through the cable guide(s).

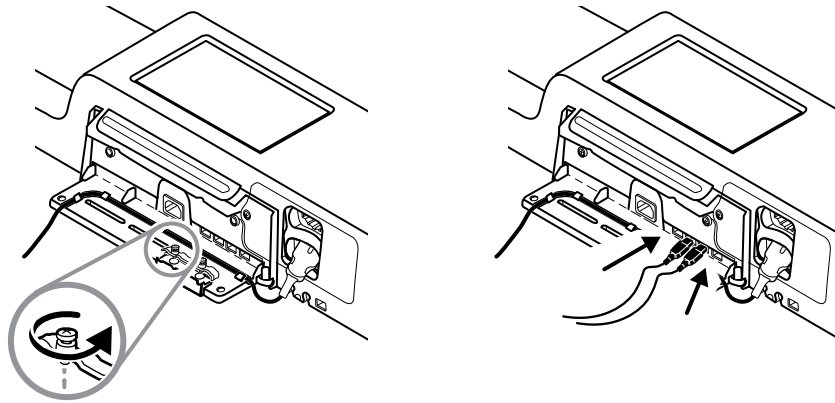

3. Replace the cable retention clamp and tighten the two screws.



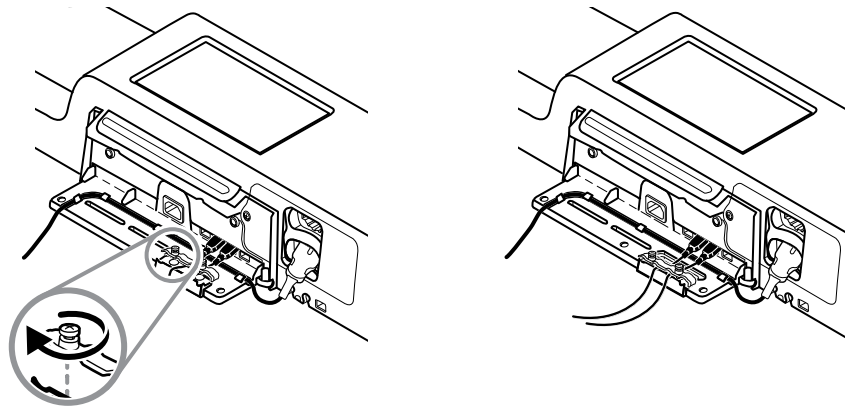

4. Re-attach the cover.
  - a. Thread the SpO2 (or SpHb) cable through the cutouts on the top right and bottom left of the cover.

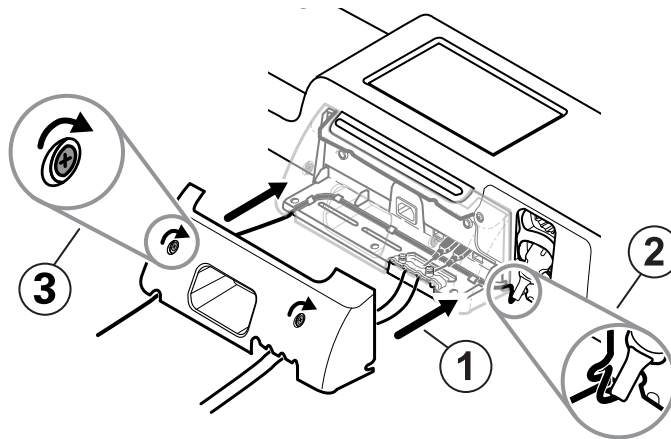

- b. Tighten the two retention screws.
5. Re-attach the system power cord and power up the wall system.



**NOTE** Some accessories require a license to enable them for use. These accessories are packaged with an authorization code and instructions for activating the license using the Welch Allyn Service Tool. For more information, refer to the instructions and the service tool installation guide.



# Startup

---

## Power

The device operates in one of two power states:

- Device powered on. The device is operating on battery power or AC power. You can utilize the device's features, and the display is active.
- Sleep (Display power-saving) mode. The device is operating on battery or AC power, but the display is off to conserve power. Settings for this mode can be changed in the Display tab in Advanced settings.



**NOTE** Battery-powered accessories connected to the device continue to charge while the device is in this mode and connected to AC power. However, if you power down the device or disconnect the device from AC power, battery-powered accessories connected to the device do not charge.

The following actions return the display to the active state:

- Touching the screen
- Removing the temperature probe from the probe well
- Attaching the SpO2 sensor to a patient
- Connecting the patient movement cable and bed sensor (sensing unit) to the device
- Attaching a sampling line to a patient
- Pressing 

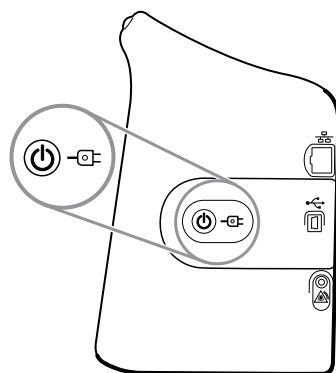

## Power on/Display power-saving button

The Power on/Display power-saving button , located on the device housing, performs the following functions:

- Powers up the device
- Opens an onscreen Power-down dialog with options to Power down, Sleep, or Cancel (brief press)
- Sets the device into Display power-saving (Sleep) mode (brief press followed by 30 seconds of inactivity)



**NOTE** The device will not enter the Sleep (Display power-saving) mode while an alarm condition is active or when NIBP intervals or continuous measurements are in progress. The device also exits this mode if an alarm occurs.

The LED in the center of the power plug symbol indicates the battery charging status:

- Green indicates that AC power is present and that the device's battery is fully charged. It does not indicate the charge level of any accessories.
- Amber indicates that AC power is present and that the device's battery is charging. It does not indicate the charge level of any accessories.

## Power up the monitor

The monitor runs a brief diagnostic self-test each time it powers up.



**WARNING** Equipment failure risk. The monitor includes a fan that circulates air through the device. If the fan does not run when you power up the device, remove it from use and inform qualified service personnel immediately. Do not use the monitor until the problem is corrected.



**WARNING** To ensure patient safety, listen for an audible indicator and watch for visual alerts at power-up at least once daily. Correct any system errors before using the monitor. In addition to the audible indicator, the monitor LED light bar illuminates to alert you of alarms. Amber indicates a low-level alarm. Flashing amber indicates a medium-level alarm. Flashing red indicates a high-level alarm.



**WARNING** Always observe the monitor during power-up. If any display fails to illuminate properly, or if an error code displays, inform qualified service personnel immediately, or call your nearest Welch Allyn Customer Service or Technical Support facility. Do not use the monitor until the problem is corrected.



**CAUTION** Always use the monitor with an adequately charged and properly functioning battery.



**CAUTION** During continuous monitoring, keep the monitor connected to AC power at all times.



**CAUTION** Use only a Class I (grounded) AC power cord for powering this monitor.

1. Press  to power up the monitor.

Following a successful self-test, the monitor displays the company logo, the LED light bar (located on the handle) flashes, and a power-up tone sounds.





**NOTE** If patient data was saved during the most recent power down and the device was in the Continuous Monitoring profile, a Confirm patient and location dialog appears with the following options:

- Same patient and location
- Same patient, new location
- New patient



**NOTE** If "Allow profile change" is enabled in Advanced settings and continuous sensors are attached to the device at startup, the device powers up in the Continuous Monitoring profile, overriding other default profile selections.

2. If the Confirm patient and location dialog appears, select the desired option and touch **OK**.

If a system error is detected, the monitor becomes inactive until you press  or until the monitor shuts down automatically. The monitor displays a system fault message that contains a wrench icon  and a system fault code to aid service and engineers in diagnosing the problem.

## Set the date and time

1. Touch the **Settings** tab.
2. Touch the **Device** tab.
3. Touch the **Date/Time** vertical tab.
4. To change the date and time values: Touch the up and down arrow keys or touch  and enter a value.

Repeat for each value you want to change.



**NOTE** The date and time stamps on saved patient measurements will adjust in response to new date and time settings.

## Power down the monitor

This power-down method, which places the monitor into Standby mode, ensures that patient measurements are retained in the monitor memory for a maximum of 24 hours. These saved measurements are available for recall or sending electronically to the network. This method also ensures that any configuration settings you have changed and saved will be maintained at the next startup.

1. Touch the **Settings** tab.
2. Touch the **Device** tab.
3. Touch **Power down**.

If there is a software update available, a system message asks if you want to upgrade the software.

4. If you want to upgrade the software, touch **OK**.

The monitor continues to charge the battery when in Standby mode.

## Reset the monitor

If the monitor stops functioning, you can press and hold  for approximately 6 seconds to allow the hardware to completely cycle off and to reset the monitor configuration settings to the last saved default power-up configuration. The button is located on the side of the monitor and on the front of the wall system.



**CAUTION** Do not use a long press of  to power down the monitor or wall system when it is functioning normally. You will lose patient data and configuration settings.

## Single sign-on (SSO)

Single sign-on (SSO) technology allows users to sign in just once to a network or server and have access to all of their authorized applications without maintaining or entering multiple passwords. If SSO has been implemented in your facility and extended to your Connex device, you can log on to the device quickly and securely with a simple scan or tap of your ID.



**NOTE** In the Continuous Monitoring profile, the single sign-on (SSO) feature is only available to confirm manual episodic save. The SSO feature is also available in the Spot Check and Intervals Monitoring profiles. If SSO is enabled, the Office profile is disabled.



**NOTE** You can capture patient vitals measurements in the Spot Check profile without a clinician login, but clinician login is required to save those vitals measurements.



**NOTE** The Intervals profile requires a clinician login to start intervals monitoring.

Follow the instructions below that apply to your situation to log on to your Connex device.

## Enter clinician information (SSO implemented)

In facilities that have implemented SSO, you can use your badge to log on to the device on either the Home tab or the Clinician tab.



**NOTE** Badge-only login is only available to authorized users who are registered in the facility.



**NOTE** Badge-only login is only available during the established grace period.



**NOTE** Attempts to log on to the device anywhere but on the Home tab or Clinician tab will result in a "Badge not accepted" message.



**NOTE** Manually entering clinician information remains an option in all SSO environments.



**NOTE** After the established grace period expires, you must enter clinician passwords or PINs manually.

1. Touch either the **Home** tab or the **Settings > Clinician** tabs.
2. Using the attached scanner or RFID reader, scan or tap your badge.

If the scan/tap is successful, the device authenticates you as an authorized user and displays your Clinician ID in the Device Status area of the Home tab.



**NOTE** If you started the login process on the Clinician tab, the device navigates back to Home tab after you authenticate.

3. If the grace period has expired and authentication is unsuccessful, manually enter your system password or PIN in the Authentication pane as prompted, then touch **OK**.

The device authenticates you as an authorized user and displays your Clinician ID in the Device Status area of the Home tab.



**NOTE** If another clinician is logged in and no unsaved vitals or patient data appear onscreen, scanning/tapping your badge logs out that clinician and logs you in.



**NOTE** If another clinician is logged in and unsaved vitals and/or patient data appear onscreen, scanning/tapping your badge opens a dialog stating that the patient data and vitals will be cleared. If you touch **OK**, you will clear the vitals and log out the other clinician. If you touch **Cancel**, the other clinician remains logged in with patient data and vitals intact.



**NOTE** If another clinician is logged in and unsaved vitals and/or patient data appear onscreen, manually entering your Clinician ID and password/PIN and then touching **OK** opens a dialog asking if you want to log out the current user. If you touch **OK**, the device clears the vitals and logs out the other clinician. If you touch **Cancel**, the other clinician remains logged in with patient data and vitals intact.



**NOTE** You can use your RFID badge to log out only if you used your RFID badge to log in. If you manually entered your clinician information to log in and then scan or tap your badge, the device treats the scan as a new clinician login.



**NOTE** During an active Intervals program, different clinicians can log in to the device. Both patient and vitals data persist when one clinician switches to another. Because patient and vitals data must be associated with a clinician ID in the Intervals profile, the device does not permit clinician logout when Intervals are running.



**NOTE** In the Continuous Monitoring profile, the single sign-on (SSO) feature is only available to confirm manual episodic save. If SSO was used when the device was in the Spot Check or Intervals Monitoring profile, applying a continuous monitoring sensor to a patient automatically logs out the current user if no patient or vitals information has been captured on the device. If you apply a continuous monitoring sensor to a patient and patient or vitals information has been captured, a dialog window opens, asking if you want to log out the current user. If you touch **OK**, the device clears the vitals, logs out the current user, and starts continuous monitoring. If you touch **Cancel**, the current user remains logged in with patient data and vitals intact, and with the same profile active on the device. You can then save the patient and vitals information before using the continuous monitoring sensor.

## Enter clinician information (SSO not available)

1. Go to the Clinician tab using one of these methods:
  - On the Home tab, touch the Clinician ID section of the Device Status area (top left corner of the screen).
  - Touch the **Settings** > **Clinician** tab.

2. To enter the clinician name, touch , located at the right of the text field, and enter characters.

You can enter up to 32 characters for the clinician's first and last name. Enter only 1 character for the middle initial.

3. To enter the clinician ID, use one of these methods:

- Touch  and enter the ID.
- Scan the clinician's barcode with a barcode scanner.



**NOTE** If "Require clinician ID match to save measurements" is enabled in Advanced settings, a progress indicator appears in the Device Status area as the device queries an external host system for a matching ID.

- An unsuccessful query results in the message, "Unable to identify clinician."
- A successful query results in clinician data replacing the progress indicator according to preferences configured in Advanced settings.

4. If prompted, enter your system password in the Authentication pane.
5. Touch **OK** to save your entries and return to the Home tab.

## Patient Protection mode

Patient Protection mode prevents access to the Review tab and Patient list without an authenticated clinician login. When Patient Protection is enabled, the Review tab is grayed out and inaccessible, but current patient information remains viewable on the Home tab. On the Patients tab, the List tab is grayed out and inaccessible, but the rest of the information accessed from the Patients tab (Summary and Manual tabs) remains viewable and editable based on the current device configuration.

An authorized person can access the **Data Management > Clinician** tab in Advanced settings to activate Patient Protection mode. (See Advanced settings.)



**NOTE** Patient Protection mode is available only in the Spot Check and Intervals Monitoring profiles.



**NOTE** You cannot change profiles while Patient Protection mode is active.



## Navigation

The monitor screen provides the interface that you use to complete your workflow. You access the monitor's features by touching the screen.

### Home tab

The Home tab includes the following areas:









Item	Area
1	Device Status
2	Content
3	Navigation

### Device Status area



The Device Status area, located at the top of the Home screen, displays the following monitor information, from left to right:

- Clinician identification. The format can be a name, ID number, or icon. Touch this area to navigate to the Clinician login.
- Device location.
- Time and date. Touch this area to navigate to date and time settings.
- Current profile. Touch this area to navigate to the Profiles vertical tab (on the Device tab), which displays available profiles.
- Connection status (wired or wireless, and central station). The icons indicate which connections, if any, are currently attempted or active.

Icon	Connection type or indicator
	Ethernet
	USB
	Wireless
	Wireless signal strength
	Attempting to connect to the central station
	Connected to central station
	Not connected to central station
Blank	No connection

- Battery condition. Estimated battery capacity is displayed in hour(s):minute(s) format. Touch this area to navigate to the Device tab, where you can power down the device.

This area also provides interactive alarm and information messages, including a Demo mode active indicator.

## Battery status

The battery status indicator displays the state of the battery.



**NOTE** Unplugging the power cord does not interrupt power to the device. Battery power runs the device, and AC power charges the battery.

The battery status is represented by icons in the right corner of the Device Status area:

- The monitor is connected to a power outlet and the battery is charging or is fully charged. The estimated charge rate is displayed as a percentage of capacity.



- The monitor is not connected to a power outlet and is running on battery power. The estimated charge time remaining is displayed in the hour(s):minute(s) format. Each section of the battery status indicator represents a percentage of remaining charge.



**NOTE** When the battery switches from AC power to battery power, no charge time is displayed while the device calculates the remaining charge time.

- The monitor is connected to a power outlet but the battery does not maintain a charge or has been removed.



When the battery is not being recharged and power becomes low, a very low-priority alarm appears in the Device Status area.



**Low battery 30 minutes or less remaining.**



**NOTE** Observe the remaining battery charge in the battery status indicator and plug the monitor into a power outlet as soon as you are able.

If the very low-priority alarm is dismissed or if you take no action to charge the battery, a high-priority alarm appears when battery power is critically low. Plug the monitor into a power outlet immediately to prevent it from powering down.



**Low battery 5 minutes or less remaining.**

Failure to plug in the monitor before the remaining charge runs out causes the monitor to power down and lose all unsaved data.

## Alarm and information messages

The Device Status area provides alarm and information messages that are either temporary or exist as long as the condition to which the message applies remains. Alarm or information messages may also include controls and/or behavior that you can use to manage alarm and information messages.

When the monitor detects an alarm condition, an alarm message appears. When multiple alarms occur, the device provides options to manually toggle or autoscroll through a stack of messages. You can cycle through each alarm message in sequence of priority by touching the multiple alarm toggle. Alternatively, the autoscroll option displays messages in the stack for approximately 4 seconds. These messages are stacked in order of priority: the monitor displays the highest priority messages first followed by each successive alarm message in order of priority. After presenting the entire stack of alarm messages, the autoscroll feature loops back to the top priority message and repeats the entire stack unless specific alarms auto-dismiss or you reset or cancel specific alarms. In

both the manual toggle and autoscroll options, when multiple alarm messages of the same priority exist at the same time, the device displays the most recent of those alarm messages first.

Information messages instruct you to interact with the monitor in a specific way or provide information that does not require action. You can dismiss an information message by selecting the control associated with the message or waiting for the message to time out. Information messages rank the lowest in priority.

When the monitor is operating in Demo mode, which requires access to Advanced settings, the Device Status area displays an information message indicating that the Demo mode is active, as shown below.



Any alarm messages that occur in Demo mode include a clear "DEMO MODE:" prefix as well.



## Content area

The Content area displays current vital sign measurements and patient identification. It also provides relevant controls.

The Content area includes the following:

- A frame for each available parameter
- The Patient frame
- The Manual parameters frame (height, weight, pain, temperature, respiration, and BMI, depending on configuration)

In the Office, Spot Check, and Intervals Monitoring profiles, the Content area also includes a Save button, which you use to manually save current measurements to the Review tab. If your monitor is connected to an external system, you can send these patient measurements to that external system as well. You can configure your monitor to automatically send these measurements any time you press Save, or you can navigate to the Review tab and then select specific records to send to the external system.

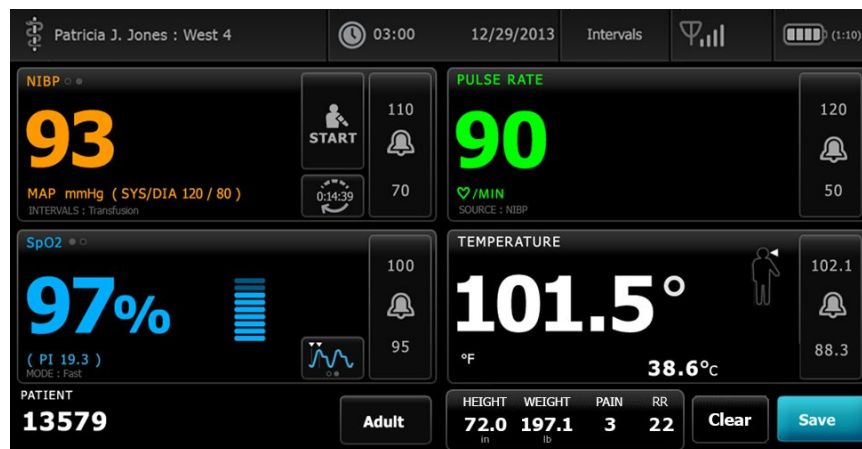

In the Continuous Monitoring profile, patient measurement data is automatically saved to the Review tab.



With the episodic save feature enabled, the workflow of a manual episodic save in the Continuous profile is initiated by use of a Save button on the Home tab. In the Continuous Monitoring profile, the Pause button appears in its place, however, with the episodic save feature enabled both buttons appear once the monitor determines the supported version of the Connex CS installed on the host server. See "Manual episodic vital sign measurements (Continuous Monitoring profile)" and "Host system" of this instructions for use. If the monitor is connected to the central station, the monitor automatically sends these patient measurements to the central station as well.



### Office profile content area

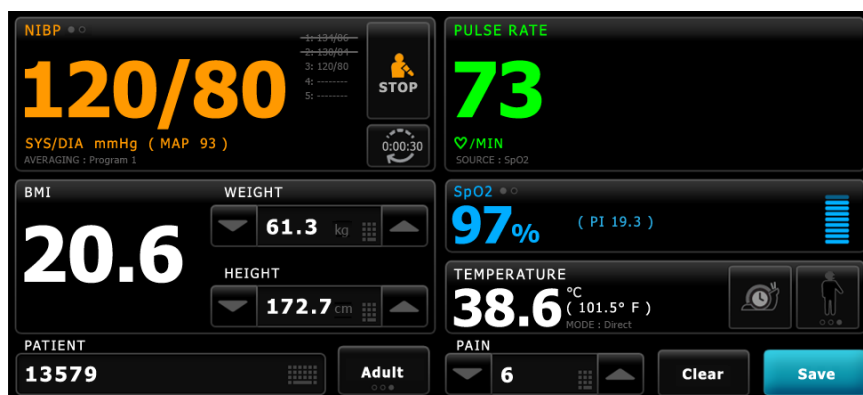

The Content area displays vital sign measurements. It also provides shortcuts to several controls.

The Content area of the Office profile includes the following frames:

- NIBP
- BMI (including weight and height)
- Patient
- Pulse rate
- SpO2
- Temperature
- Pain

The Content area also includes a **Save** button, which you use to manually save current measurements.

The **Clear** button deletes current measurements without saving them.

## Save patient data

Patient data can be saved to the monitor.

After taking a patient reading, touch **Save**.

A message appears indicating a successful save or a failed save.



**NOTE** During an NIBP averaging program, after acquiring an NIBP measurement, the monitor saves all measurements displayed on the Home tab and associated patient identification. To retain an NIBP average, touch **Save** upon completion of the averaging program.

## Navigation area



The Navigation area includes the following tabs:

- **Home:** Displays vital-sign measurements and provides shortcuts to several controls.
- **Patients:** Accesses the patient list, patient summary, and manual parameters.
- **Alarms:** Accesses global alarm response and settings controls, alarm limit settings (available only in the Intervals Monitoring and Continuous Monitoring profiles), and patient rest mode.
- **Review:** Prints, deletes, and sends patient data.
- **Settings:** Accesses device configuration settings.

To navigate to a tab, touch the tab in the Navigation area with the corresponding name. The active tab is highlighted.



**NOTE** If Patient Protection mode is active and no clinician has logged in to the device, the Review tab will be grayed out and inaccessible. The List tab, which you access from the Patients tab, also will not be accessible.

## Display lock

The display lock feature blocks the display of patient information and also prevents both screen navigation and data input, which might be useful when cleaning the display. You can activate display lock manually or, depending on the device configuration, set the device to lock automatically after a specific idle period.

The display locks when any of the following occur:

- You touch **Lock display now** on the Device tab.
- No interaction with the monitor occurs for the period specified on the Display tab in Advanced settings. (An authorized person can access the Display tab in Advanced settings and set or change the length of the idle period that triggers the display lock.)

## Lock the display

Follow these steps to lock the display.

1. Touch the **Settings** tab.
2. Touch the **Device** tab.
3. Touch **Lock display now**.

The following occurs:



- The Home tab appears with a large lock icon  on the lower left of the display.
- The following information no longer appears on the screen:
  - Clinician ID
  - Patient ID
  - Manual parameters frame
  - Navigation tabs
- All controls on the display are locked. If you touch the display, you either unlock the display immediately (no security configuration implemented) or receive a prompt to enter credentials (security configuration implemented) to unlock the display.

## Unlock the display

1. Touch anywhere on the locked display.

If no security configuration has been implemented, the display unlocks immediately.

2. If a security configuration or single sign-on (SSO) has been implemented on the device, enter the requested credentials (ID number, access code, and/or password) based on your facility's security policy. Where SSO has been implemented, scanning or tapping your badge overrides manual entry of your credentials if you haven't exceeded the established grace period.

The display unlocks when the device authenticates your credentials.

3. If the SSO grace period has expired and authentication is unsuccessful, manually enter your system password or PIN as prompted, then touch **OK**.

The device authenticates you as an authorized user and displays your Clinician ID in the Device Status area of the Home tab.



**NOTE** An authorized person can adjust security configuration and SSO settings in Advanced settings.

4. If Patient Protection mode is active and "Continue without login" has been enabled in Advanced settings, select the condition(s) below that apply to you and follow that step.
  - a. No clinician logged in; Touch **Continue without login**, or scan or enter the requested credentials as prompted (ID number, access code, and/or password) and touch **OK**.

The display unlocks and displays patient information just as it appeared before the display was locked.



**NOTE** Using the device access code will clear the lock screen leaving the device in the state it was in before being locked.



**NOTE** Using "Continue without login" to clear the lock screen always engages Patient Protection mode.

- b. Clinician logged in; Touch **Continue without login**, or scan or enter the requested credentials as prompted (ID number, access code, and/or password) and touch **OK**. Scan or enter additional credentials as prompted to authenticate and touch **OK**.

The display unlocks and displays patient information according to the level of authentication provided.



**NOTE** Using the device access code will clear the lock screen leaving the device in the state it was in before being locked.



**NOTE** If one clinician is logged in and the same clinician logs back in to unlock the display, then the patient information will appear just as it was before the display was locked.



**NOTE** If one clinician is logged in, a different clinician can log in and automatically log out the other clinician. The configuration of your device and the security policy of your facility determine whether the confirmation dialogs appear and whether patient information persists on the screen after logging out another clinician.



**NOTE** If a clinician is logged in, touching the **Continue without login** opens a dialog window asking if you want to log out the current user. If you touch **OK**, the device clears the vitals and logs out the other clinician. If you touch **Cancel**, the screen remains locked.



**NOTE** Using "Continue without login" to clear the lock screen always engages Patient Protection mode.

The display also unlocks when the following occur:



- A high- or medium-priority alarm.
- An externally initiated action, such as taking or stopping an NIBP measurement or upgrading software.



## Using the keypad, keyboard, and barcode scanner

---

### Open the numeric keypad

Touch any field that includes the numeric keypad icon .

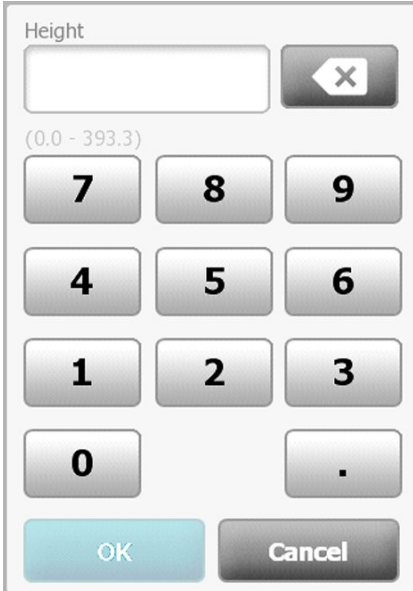

The numeric keypad appears.

### Numeric keypad



The numeric keypad includes the following components:

Component	Name	Description
	Data field	Displays the numbers you enter. The field name appears above and the range of values you can enter appears below this field.

Component	Name	Description
	Backspace key	When touched, removes the rightmost number from the data field.
	Cancel button	When touched, the numeric keypad disappears and the selected number does not change.
	OK button	When touched, the numeric keypad disappears and the entered number appears in the associated frame or data field.

## Enter a number

- With the numeric keypad open, touch a number or numbers.  
The value must be within the range that appears below the data field.
- Touch **OK**.
  - If the value is within the required range and format, the numeric keypad disappears and the entered numbers replace the previous numbers.
  - If the number is not within the required range and format, **OK** remains inactive until you enter a valid number.

## Close the numeric keypad

Touch one of the following:

- OK**: Exits the numeric keypad and inserts the number.
- Cancel**: Exits the numeric keypad without saving entered numbers.

## Open the keyboard







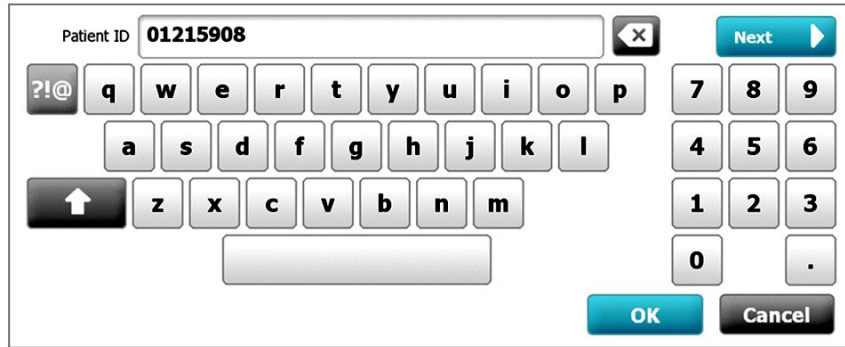

Touch any field that includes the keyboard icon .





The keyboard appears.

# Keyboard



The keyboard includes the following components:

Component	Name	Description
	Data field	Displays the characters you enter.  <b>NOTE</b> The keyboard can be configured to mask character entries and display them as asterisks.
	Backspace key	When touched, removes the rightmost character from the data field.
	Space bar	When touched, enters a space in the data field.
	Shift key	When touched, enters the next letter as uppercase.
	Letters key	When touched, returns to the primary keyboard layout. The keyboard changes from normal layout when you touch one of these: <ul style="list-style-type: none"> <li>• The symbols key</li> <li>• The diacritical marks key</li> </ul>
	Symbols key	When touched, the keyboard displays symbols. The keyboard returns to its normal layout when you touch one of these: <ul style="list-style-type: none"> <li>• Any symbol</li> <li>• The letters key</li> <li>• The symbols key</li> </ul>  <b>NOTE</b> The symbols that display match the selected language.

Component	Name	Description
	Diacritical marks key (appearance varies in some languages)	When touched, the keyboard displays letters with diacritical marks. The keyboard returns to its normal layout when you touch one of these: <ul style="list-style-type: none"> <li>Any letter</li> <li>The letters key</li> <li>The diacritical marks key</li> </ul>
	Next button	When touched, accepts the entry for the current field, then clears the field to allow data entry for the next field.
	Cancel button	When touched, the keyboard disappears and the content of the data field remains the same.
	OK button	When touched, the keyboard disappears and the entered characters appear in the data field.



**NOTE** This key appears only when the selected language uses diacritical marks.

## Enter a letter or number

- With the keyboard open, touch letters or numbers.
- Do one of the following:
  - Touch **Next**. This control accepts the entry for the current field, then clears the data field to allow data entry in the next field.
  - Touch **OK**. The keyboard disappears and the entered characters appear in the data field.

## Enter a symbol or special character



**NOTE** To return to the keyboard's normal layout, touch .

- With the keyboard open, touch . Symbols and special characters for the selected language appear.

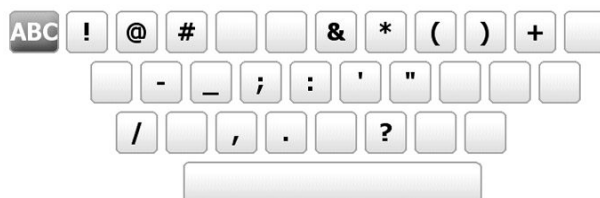

- Touch the appropriate symbol or special character.

The keyboard returns to its normal layout.

## Enter a diacritical mark



**NOTE** Keyboards with diacritical marks are available only for languages that use diacritical marks.



**NOTE** To return to the keyboard's normal layout without saving changes, touch



Diacritical marks key	Language(s)
None (Not applicable)	Danish, English, Dutch, German, Italian
	French
	Finnish, Norwegian, Spanish, Swedish
	Portuguese
	Polish
	Greek

1. With the keyboard open, touch the diacritical marks key. This key varies based on the language, as noted above.

The keyboard displays diacritical marks for the selected language and therefore varies from one language to another. On each diacritical marks keyboard, the letters key in the top left corner returns you to the standard keyboard.

2. Touch a diacritical mark.

The keyboard returns to its normal layout.

## Close the keyboard

Touch one of the following:

- **Next:** Accepts the entry for the current field, then clears the field to allow data entry for the next field.
- **OK:** Exits the keyboard and inserts the data.
- **Cancel:** Exits the keyboard without saving entered data.

## Use a barcode scanner

The monitor enables the scanning of patients' and clinicians' barcodes to enter ID information. The barcode scanner supports linear and two-dimensional barcodes.

If you haven't done so already, power down the monitor and attach the barcode scanner. Use the instructions to attach an accessory.



**NOTE** Refer to the manufacturer's instructions for use to ensure that the scanner is set to USB Com Emulation mode.

1. Remove the barcode scanner from its holder.
2. Hold the scanner approximately 6 inches (15.4 cm) from the barcode and squeeze the trigger so that the light from the scanner appears on the barcode.

Once the scanner completes a successful barcode reading and any required queries for a matching ID on the device or in an external host system, the ID appears in the targeted area (Patient frame, data field, or Device Status area). See additional notes below.

If the scanner has difficulty reading the barcode, slowly adjust the distance and the angle between the scanner and the barcode while squeezing the scanner trigger. If it continues to have difficulty, verify that the barcode is as flat as possible.



**NOTE** You can scan a patient's barcode from the Home tab or the Summary tab. The scanned ID appears in the Patient frame on the Home tab and in the Patient ID field on the Summary tab.

Before you scan a barcode on the Summary tab, touch the keyboard icon in the Patient ID field. To return to the Home tab and begin taking patient measurements, touch **OK**.



**NOTE** If "Require patient ID match to save measurements" is enabled in Advanced settings, a progress indicator appears onscreen as the device queries an external host system or the device's Patient list for a matching ID.

- An unsuccessful query results in the message, "Unable to identify patient."
- A successful query results in patient data populating fields and appearing onscreen according to preferences configured in Advanced settings.



**NOTE** If "Require clinician ID match to save measurements" is enabled in Advanced settings, a progress indicator appears onscreen as the device queries an external host system for a matching ID.

- An unsuccessful query results in the message, "Unable to identify clinician."
- A successful query results in clinician data replacing the progress indicator according to preferences configured in Advanced settings.



**NOTE** Scanning a clinician ID while the Clinician ID pane is open places the scanned ID into the Clinician ID section of the Device Status area. Touch **OK** to return to the Home tab and to begin taking patient measurements.



**NOTE** Use the Advanced settings Data Management tab to change the appearance of the Clinician ID if you do not want your ID to appear in the Device Status area. (This requires the Advanced settings access code.) However, this information is still retained in the monitor memory for recall, printing, or to send measurements electronically to the network.



## Host system

### Overview

A monitor can be used as standalone device or be networked to a compatible Welch Allyn host system or central station. This section describes communication between the monitor and the host system.

Monitors communicate with the host system through hardwired Ethernet and wireless networks. The diagram below shows monitors connected to the host system.

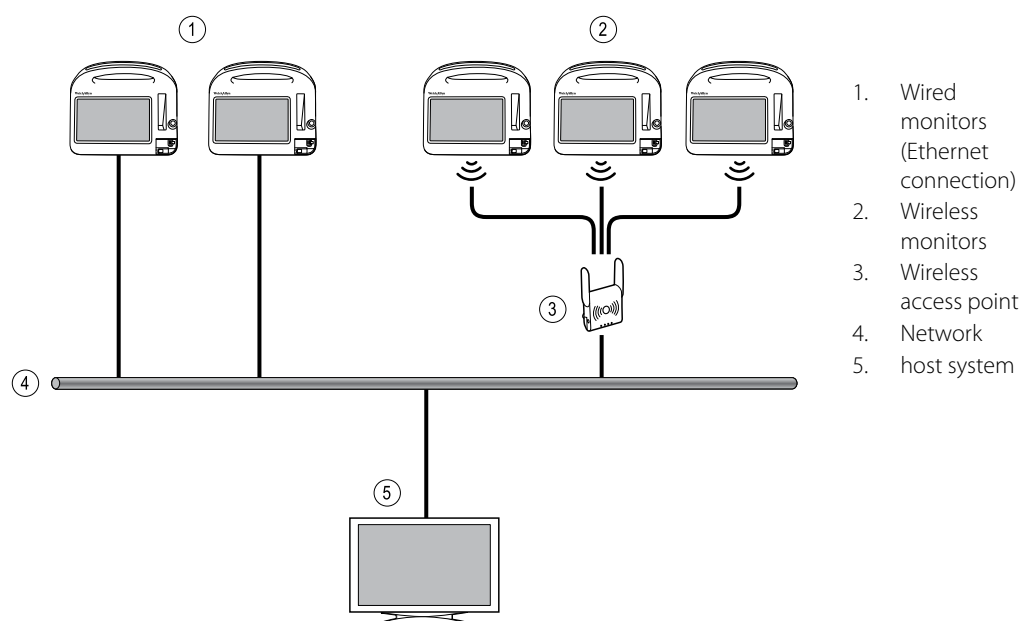

The host system provides centralized monitoring of connected monitors. This central monitoring system supports the communication of continuously monitored and intermittently acquired (episodic) data, patient vital-sign alarms, and technical equipment alerts, as well as the review and printing of all stored data.

Communication between the monitor and the host system is bi-directional but varies based on the active profile and selected advanced settings. In all profiles, for example, episodic patient data can be saved and sent to the host system, but in the Continuous Monitoring profile, patient vital-signs data streams to the host system automatically when the monitor is connected to the host system. You can enable or disable automatic connection to the host system in Advanced settings.

Furthermore, you can add patients to a patient list on the monitor and then send them to the host system, and you can also retrieve patient lists from a host system. In the Intervals Monitoring and Spot Check profiles, retrieving the patient list requires user action. In the Continuous Monitoring profile, the patient list on the monitor updates automatically when the monitor is connected to the host system.

Once you assign a patient to a monitor and send this information to the host system, you can edit patient information on the monitor as noted in the following table:

<b>Editable patient information based on profile and host system communication</b>	<b>Patient ID</b>	<b>Patient name</b>	<b>Patient location</b>	<b>Patient type</b>
Spot Check and Intervals profiles	X	X	X	X
Continuous Monitoring profile, communicating with the host system			X	X
Continuous Monitoring profile, not communicating with the host system		X	X	X



**NOTE** In many cases, changing patient information opens an onscreen dialog asking you to confirm the action. These dialogs appear whenever the action results in clearing patient measurement data or patient context.

If a monitor loses its connection to the host system, the device continues to monitor the patient, display patient data, and generate alarms and messages. When connectivity is restored, the monitor resumes sending vital-signs trends and episodic data.

## Monitor tab

The Monitor tab provides the following controls related to continuous patient monitoring at the device and the streaming of patient vital-signs data to a host system:

- End Monitoring – Stop continuous monitoring on the current patient and clear patient data on the device.
- Pause – Pause continuous monitoring as well as alarms for a specified period and retain patient data on the device.
- Change pause interval – Increase or decrease the pause interval in 15 minute increments up to 2 hours.
- Connect to host system – Manually connect to a host system and start or resume the streaming of patient vital-signs data when the device does not connect automatically.
- Disconnect from host system – Manually disconnect the device from a host system yet continue monitoring the patient and retain patient vital-signs data on the device. This control is only available after connecting to a host system.

The sections which follow provide instructions for using these controls.



**NOTE** This tab is visible only when the Continuous Monitoring profile is active. It is not available in the Office, Spot Check, or Intervals Monitoring profiles.





**NOTE** The Continuous Monitoring profile is available only on devices with a Continuous Monitoring profile license.

## Connect to the central station

To connect the monitor to a central station over a wireless or Ethernet network connection while in the Continuous Monitoring profile, you must first enable the **Connect to CS** option in Advanced settings. When this control is enabled, the monitor automatically attempts to connect to the central station and continues to do so until a connection is achieved.

If the Continuous Monitoring profile is active but your device has been disconnected from the central station (you will see the  indicator in the Device Status area), you can restore the connection manually.

1. Touch the **Settings** tab.  
The Monitor tab appears.
2. Select  **Connect to central station**.

As the monitor attempts to connect to the central station, a  appears in the Device Status area until a connection is achieved. When the monitor connects to the central station,

the  indicator appears.

The Connect to CS control described above only impacts the Continuous Monitoring profile, but you can configure Intervals Monitoring and Spot Check profiles to communicate with a central station as well in Advanced settings. In these configurations, if either the Intervals Monitoring or Spot Check profile is active, your device connects to the central station when you retrieve a patient list or load a patient's previously saved records with a barcode scanner. In addition, you can send episodic data to the central station when you touch Send on the Patient Review tab.

## Disconnect from the central station

Disconnecting from the central station enables you to stop streaming data to the central station yet continue monitoring your patient, retaining patient vital signs data on the monitor. Select this option when you need to transport a patient yet continue monitoring them.

1. Touch the **Settings** tab.  
The Monitor tab appears.
2. Select  **Disconnect from central station**.  
If reasons for disconnecting from the central station have been configured in Connex CS, a Disconnect dialog appears with a list box of reasons.
3. Select a reason for disconnecting, if applicable, then touch **OK**.  
The Home tab appears.

## Continuous patient monitoring

Your device must be configured with the Continuous Monitoring profile to perform continuous patient monitoring.

### Key terms

Patient context	Condition in which a patient ID and patient type have been selected on a device.
Location context	Condition in which a room or a room and bed have been selected on a device.

You have the option to continuously monitor patients on the device alone (primary monitoring) or to stream continuous patient data to a central station as well (secondary monitoring).

If Continuous Monitoring has been configured as the default profile, then the device starts up in this profile. If the Continuous Monitoring profile is active, you can proceed with an existing patient and/or location context, or you can assign a patient and location.

## Activate the Continuous Monitoring profile

If the Continuous Monitoring profile is not active, follow these steps:

1. Touch the **Settings** tab.
2. Touch the **Device** tab.

The Profile vertical tab appears.

3. Select **Continuous Monitoring**.

When neither patient nor location context are established and no patient measurements have been taken or saved, the Continuous Monitoring profile immediately becomes active. If these conditions do not apply, proceed to step 4.



**NOTE** If you switch to Continuous Monitoring, apply a Continuous Monitoring sensor to a patient and patient, or if vitals information has been captured, a dialog window opens, asking if you want to log out the current user.

4. Using the conditions presented in boldface text, select and follow the steps below that apply to your patient and the device.

- a. **When patient and/or location context are established but no patient measurements have been taken or saved:**

A confirmation dialog appears asking you to confirm the patient and/or location context information or select a new patient. For example, if both patient and location context have been established, the following options appear:

- Same patient, same location
- Same patient, different location
- New patient

Select the desired option and touch **OK**.

- b. **When patient and/or location context are established and patient measurements have been taken or saved:**

A confirmation dialog appears with the following message: "Changing to the Continuous Monitoring profile deletes all measurement data from the device. Continue anyway?"

1. Touch **Yes** to confirm or **No** to cancel the profile change.



**NOTE** Selecting **No** enables you to send captured vitals data on the device before changing profiles. After you complete that task, if applicable, repeat steps 1 to 3.

Another confirmation dialog appears asking you to confirm the patient and/or location context information or select a new patient. For example, if both patient and location context have been established, the following options appear:

- Same patient, same location
- Same patient, different location
- New patient

2. Select the desired option and touch **OK**.

The profile change immediately takes effect.

5. Touch the **Home** tab.

You can now start monitoring a patient in the Continuous Monitoring profile.

## Pause continuous monitoring (Pause mode)

You can temporarily pause continuous monitoring and retain patient data on the device when your patient needs to ambulate, use the restroom, or go off the unit for a test.



**NOTE** If a low-battery alarm occurs on the device, Pause mode is not available.



**NOTE** While in Pause mode, the device retains previously stored patient data, but it does not display this data or store additional patient measurements until you exit Pause mode.

1. Touch **Pause** on the Home tab.

A "Pause" dialog appears, indicating that you have paused continuous monitoring. Controls on this screen provide options to resume or end monitoring. A countdown timer displays the time remaining before continuous monitoring resumes.



**NOTE** You can configure the Pause Mode timeout in Advanced settings.

2. To increase the pause interval, repeatedly touch the **+** symbol until the desired length of time appears.

The pause interval is automatically applied.

## Resume continuous monitoring

You can resume continuous monitoring after a pause when patient sensors are connected to a patient. The status of the pause timer determines your next step.

### Pause time remaining

If the pause time limit has not expired (time remains on the countdown timer), resume monitoring as follows:

1. Reconnect patient sensors to the patient as needed.
2. Touch **Resume monitoring**.

The Home tab appears and continuous monitoring resumes.

## Pause time limit expired (patient sensors connected)

If the pause time limit has expired and you have already reconnected patient sensors to the patient and/or the device, the Home tab appears and continuous monitoring automatically resumes.

## Pause time limit expired (patient sensors disconnected)

If the pause time limit runs out before you resume monitoring, the device exits Pause mode, and alarms might occur.

Reconnect patient sensors to the patient and/or device and acknowledge alarm and information messages as needed.

Continuous monitoring resumes.

## End continuous monitoring

When you no longer need to monitor a patient continuously, follow these steps to end monitoring:

1. Touch the **Settings** tab.  
The Monitor tab appears.
2. Touch **End monitoring**.

An "End monitoring" dialog appears with the following options:

- New patient – Clears patient and location context and review data after you remove patient sensors
- Power down – Clears patient and location context and review data, and powers down the device
- Cancel – Retains patient data and returns to Home tab

3. Select the desired option.



**NOTE** After approximately 30 seconds of inactivity, the "End monitoring" dialog disappears. If you do not respond to this dialog and continuous monitoring is interrupted, the "Confirm patient and location" dialog appears. You must respond to this dialog before continuous monitoring resumes.

4. If you select New patient, follow the onscreen prompt to remove sensors from your patient (and the device, if applicable), and then touch **OK**.

The Home tab appears.

## Assign a patient and location

You can assign a patient and location after you have begun to monitor a patient's vital signs.

When you start to continuously monitor a patient on a device that has no patient context, the following information message appears in the Device Status area: "Assign patient and location."

1. In the top right corner of the screen, touch **Assign**.

The List tab appears.



**NOTE** When the monitor is connected to a central station, the monitor automatically retrieves the patient list when you navigate to the Patients tab.

2. If you see your patient's name on the patient list, select that patient entry, and then touch **Select**.

The Home tab appears with patient and/or location information filled in according to your monitor's settings.



**NOTE** If patient name or location information is missing, the monitor will prompt you to "Assign patient" or "Assign location" until that information is complete. You can monitor the patient without entering all of these details.

3. If your patient's name does not appear on the patient list, touch **Add**.

4. In the Patient pane, touch  in a field and enter patient information. Touch **Next** to cycle through the patient data fields.



**NOTE** You can use a barcode scanner to enter a patient ID in the Patient ID field. Touch  in the Patient ID field, scan the barcode, and touch **OK**.



**NOTE** If "Require patient ID match to save measurements" is enabled in Advanced settings, a progress indicator appears onscreen as the device queries an external host system or the device's Patient list for a matching ID.

- An unsuccessful query results in the message, "Unable to identify patient."
- A successful query results in patient data populating fields and appearing onscreen according to preferences configured in Advanced settings.

5. In the Location pane, select an available room and bed from the list box.



**NOTE** The Location list only presents locations that are not already assigned to a continuous monitoring device.

"No location assigned" appears in the list box until you select a room and bed.

6. Touch **OK** to return to the Home tab.

The information is saved.



**NOTE** You have the option to leave some fields blank on the Patient > Summary tab. However, if patient name or location information is missing, the monitor will prompt you to "Assign patient" or "Assign location" until that information is complete. You can monitor the patient without entering all of these details.





## Profiles

---

Profiles are variations of the Home tab. Each profile gives you access to a different set of features. Choose the profile that best suits your needs.

The monitor offers multiple profiles—including Continuous Monitoring, Intervals Monitoring, Spot Check, and Office—based on the configuration and any upgrade licenses you purchase.

### Continuous Monitoring profile

The Continuous Monitoring profile is designed for continuous patient monitoring. Monitors configured with Oridion Microstream® Capnography provide continuous monitoring of end-tidal CO<sub>2</sub> (etCO<sub>2</sub>), fraction of inspired CO<sub>2</sub> (FiCO<sub>2</sub>), respiration rate (RR), pulse rate, and Integrated Pulmonary Index (IPI). Monitors configured with the Nellcor pulse oximetry option provide continuous monitoring of oxygen saturation of hemoglobin (SpO<sub>2</sub>) and pulse rate. Monitors configured with the Masimo rainbow SET option may provide continuous monitoring of oxygen saturation of hemoglobin (SpO<sub>2</sub>), total hemoglobin (SpHb or SpHbv), Acoustic Respiration (RRa), and pulse rate. Monitors configured with EarlySense provide continuous monitoring of respiration rate (RR), pulse rate, and patient movement.

The Continuous Monitoring profile also enables you to take manual temperature or NIBP readings, to use alarms and timed intervals, and to use bi-directional controls to transmit data between the monitor and a central station.

Episodic save in Continuous profile is a function that allows you to manually save a group of vitals along with manual parameters and modifier information into a confirmed episodic record in Continuous Monitoring profile. This feature is only available when the monitor is connected to a Connex CS host system that supports the manual episodic save records. See "Saving episodic vital sign measurements (Continuous Monitoring profile)" later in this section.



**NOTE** Patient data continuously streams to a central station only in the Continuous Monitoring profile.



**NOTE** If "Allow profile change" is enabled in Advanced setting, the device attempts to change to the Continuous Monitoring profile automatically when a continuous sensor (CO<sub>2</sub>, RRa, EarlySense) is attached to the device. See "Change to the Continuous Monitoring profile" later in this section.



**NOTE** In the Continuous Monitoring profile, the single sign-on (SSO) feature is only available to confirm manual episodic save.

Oridion CO2-based Home tab



Masimo RRa-based Home tab



EarlySense patient movement-based Home tab

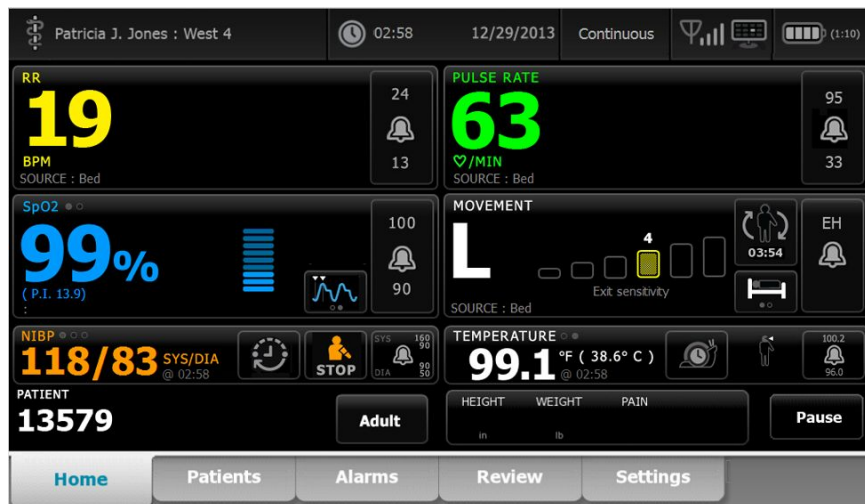

## Saving vital sign measurements (Continuous Monitoring profile)

In the Continuous Monitoring profile, measurements are automatically saved as follows:

- Continuous measurements (SpO<sub>2</sub>, SpHb, pulse rate, etCO<sub>2</sub>, FiCO<sub>2</sub>, IPI, respiration rate, and patient movement) are saved once per minute.
- When any measurements fall outside of alarm limits, all continuous measurements are saved.
- NIBP and predictive temperature measurements are saved when acquired.
- Manual parameters are saved when you touch **OK** on the Manual tab.
- Modifiers are set when you complete parameter setup and return to the Home tab. These modifiers do not appear on the Review tab.

After 24 hours of data has been saved for the selected patient, any data older than 24 hours is deleted from the monitor.



**NOTE** The monitor does not retain Direct mode temperatures in memory. Therefore, you must note the temperature before removing the probe from the measurement site and then manually record it in the patient record.



**NOTE** In the Continuous Monitoring profile, the single sign-on (SSO) feature is only available to confirm manual episodic save. If SSO was used when the device was in the Spot Check or Intervals Monitoring profile, applying a continuous monitoring sensor to a patient automatically logs out the current user if no patient or vitals information has been captured on the device. If you apply a continuous monitoring sensor to a patient and patient or vitals information has been captured, a dialog window opens, asking if you want to log out the current user. If you touch **OK**, the device clears the vitals, logs out the current user, and starts continuous monitoring. If you touch **Cancel**, the current user remains logged in with patient data and vitals intact, and with the same profile active on the device. You can then save the patient and vitals information before using the continuous monitoring sensor.

## Manual episodic vital sign measurements (Continuous Monitoring profile)

In the Continuous Monitoring profile, you can still manually save vital sign measurements to the monitor and transmit data to the connected central station. This procedure saves measurements displayed on the Home tab, along with patient identification, manual parameters, and modifiers.



With the episodic save feature enabled, the workflow of a manual episodic save in the Continuous profile is initiated by use of a Save button on the Home tab. Upon power up of the monitor or transition into the Continuous profile from another profile, the Save button will not be available immediately. However, upon a connection to the Connex CS system, the monitor determines the version of Connex CS installed on the host server and if supported, the Save button will appear once the connected monitor confirms the supported version of Connex CS installed.



If needed, touch **Pause** on the Home tab. A "Pause" dialog appears, indicating that you have paused continuous monitoring. Controls on this screen provide options to resume or end monitoring. A countdown timer displays the time remaining before continuous monitoring resumes.



**NOTE** In the Continuous Monitoring profile, the single sign-on (SSO) feature is only available to confirm manual episodic save. See "Enable single sign-on" in the Advanced settings if the following information message appears: "Single sign on only available to confirm manual episodic save in Continuous Monitoring profile." The information message indicates that Single sign on is only available as part of the confirmation process for a manual episodic save.



## Enter manual parameters (Continuous Monitoring profile)



**NOTE** The Manual parameters frame enables you to add manual parameters and modifiers, including custom parameters and modifiers.

1. As part of the episodic save workflow, touch **Save** after taking a patient reading.



The Manual tab appears.

2. Enter manual parameters and modifiers on the Patients Manual tab and then touch **Next**.
3. Touch the keypad icon in selected fields to open the numeric keypad, and then manually adjust height, weight, pain level, temperature, respiration rate, or other parameters and modifiers.
4. Touch **Next**.



**NOTE** The Clinician confirmation dialog may appear, or may appear differently, based on whether features such as "Require password" or "Enable single sign-on" are selected in Advanced settings.

5. If prompted, enter your clinician ID and then touch **OK** at the confirmation dialog.
6. With a successful clinician confirmation in manual episodic save, the monitor returns to Home tab with a message indicating a successful or failed save.





## Intervals Monitoring profile

The Intervals Monitoring profile enables you to use alarms and timed NIBP intervals for patient monitoring.

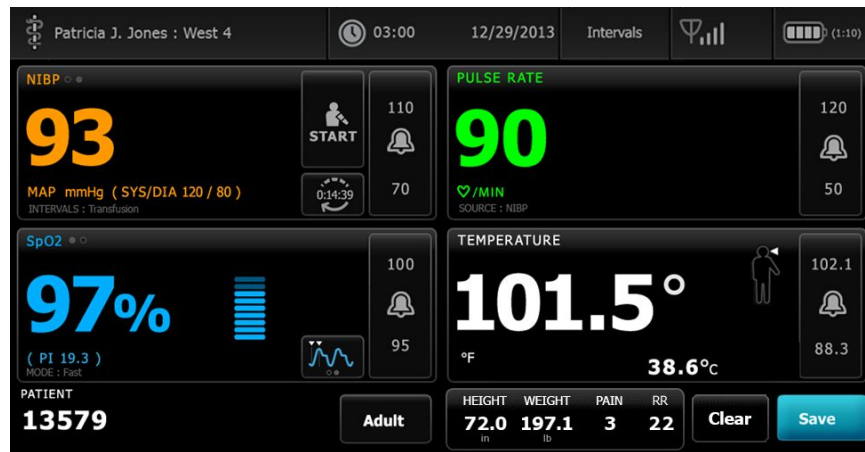

**NOTE** Patient vital signs data streams to a central station only in the Continuous Monitoring profile.



**NOTE** The Intervals profile requires a Clinician login to start intervals monitoring, and SSO is available in this profile.



**NOTE** Clinician logout is not permitted during an active intervals program.

## Spot Check profile

The Spot Check profile is optimized for clinicians who take spot-check vital readings and do not need automatic reading or alarm features.

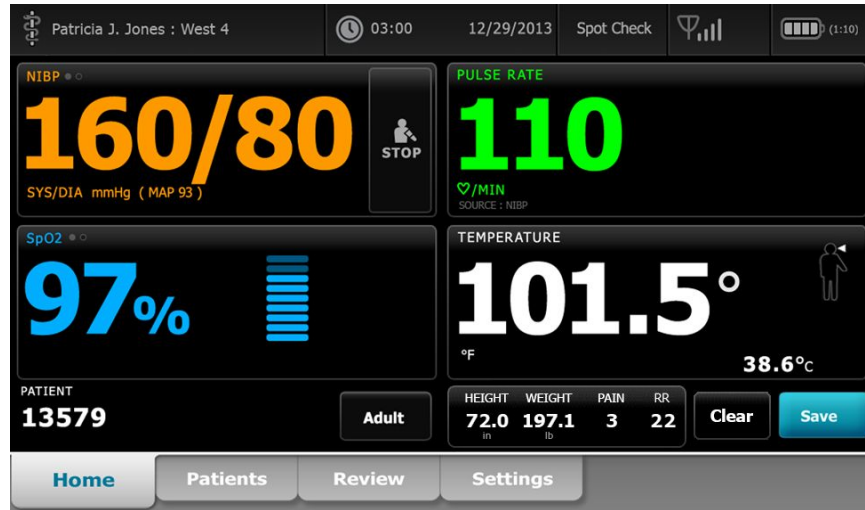

**NOTE** SSO is available in the Spot Check profile.



**NOTE** You can capture patient vitals measurements in the Spot Check profile without a clinician login, but clinician login is required to save vitals measurements.

## Office profile

The Office profile is designed for outpatient clinical settings, such as a physician's office, and has the following features:

- Noninvasive blood pressure (NIBP) averaging programs: These programs display the average of multiple NIBP readings.
- Calculation of body mass index (BMI): The device calculates BMI based on weight and height input entered manually or transferred from a connected weight scale.

You can also take manual NIBP and temperature measurements, monitor pulse rate and SpO2, and manually enter pain level.



**NOTE** The single sign-on (SSO) feature is not available in the Office profile.

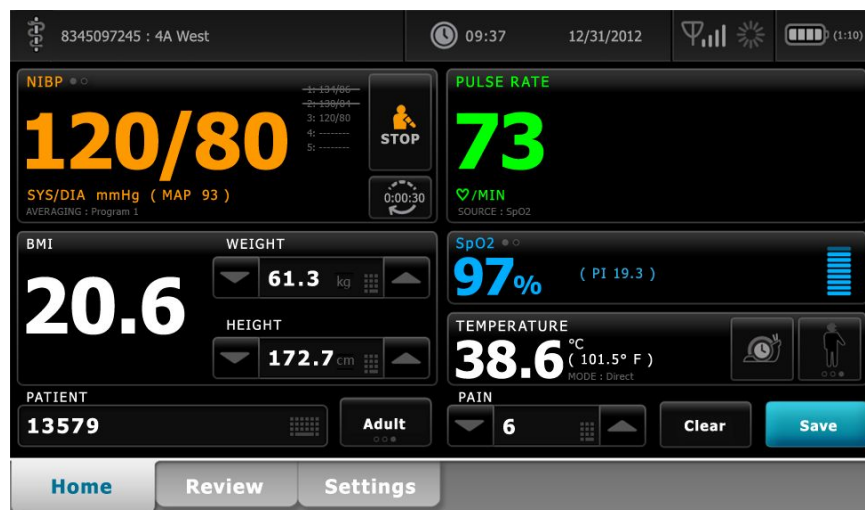



## Saving vital sign measurements (Intervals Monitoring, Spot Check, and Office profiles)

In the Intervals Monitoring, Spot Check, and Office profiles, you can manually save vital sign measurements to the monitor. This procedure saves measurements displayed on the Home tab, along with associated patient identification and modifiers.

After taking a patient reading, touch **Save**.

A message appears indicating a successful or failed save.



**NOTE** During intervals, measurements displayed on the Home tab, along with associated patient identification, are automatically saved after each interval measurement is acquired and when some alarm conditions occur. Modifiers are automatically saved with the first NIBP reading only but not subsequent readings with NIBP intervals running. Throughout intervals monitoring, you can manually save measurements as well.



**NOTE** The monitor does not retain Direct mode temperatures in memory. Therefore, you must note the temperature before removing the probe from the measurement site and then manually record it in the patient record.



**NOTE** SSO is only available in the Spot Check and Intervals Monitoring profiles, or to confirm manual episodic save in the Continuous Monitoring profile.



**NOTE** You can capture patient vitals measurements in the Spot Check profile without a clinician login, but clinician login is required to save those vitals measurements.



**NOTE** The Intervals profile requires a clinician login to start intervals monitoring.

## Profile feature comparison

The following table compares the features of the profiles.

<b>Feature</b>	<b>Continuous Monitoring</b>	<b>Intervals Monitoring</b>	<b>Spot Check</b>	<b>Office</b>
Take NIBP, SpO2, temperature, and pulse rate measurements	X	X	X	X
Configure and use NIBP averaging programs				X
Take SpHb measurements (Masimo only)	X	X		
Monitor etCO2, FiCO2, and IPI (Oridion only)	X			
Monitor RR (EarlySense and Oridion only)	X			
Monitor patient movement (EarlySense only)	X			
Monitor RRa (Masimo only)	X			
Configure and use interval timing setting	X	X		
Observe and configure alarm limits	X	X		
Observe and respond to physiological alarms	X	X		
Change patient type (adult, pediatric, neonate)	X	X	X	X
View and enter manual parameters	X	X	X	
Temperature*	X	X	X	
Weight	X	X	X	X
Height	X	X	X	X
BMI**	X	X	X	X***
Pain	X	X	X	X
Respiration rate	X	X	X	
Save currently displayed vital signs data to device memory	X	X	X	X
Clear patient data without saving		X	X	X
Review saved vital signs data	X	X	X	X

Feature	Continuous Monitoring	Intervals Monitoring	Spot Check	Office
Use bi-directional controls between monitor and external systems	X	X	X	X

\* Braun IR thermometers configured to work with the monitor transfer temperature data automatically to the Temperature frame. You can enter temperature manually if you take a patient temperature with a thermometer that is not connected to the monitor, and you have selected temperature as one of the four manual parameters to display.

\*\* In the Spot and Office profiles, Body Mass Index (BMI) is calculated based on weight and height values that are either entered manually or transferred from an attached weight scale. The Office profile displays BMI in its own frame. In the Spot profile, BMI displays in the Manual parameters frame if you have selected it as one of the four parameters to display. In all profiles, BMI is a read-only field that clears or recalculates with changes to height or weight values..

\*\*\* The Office profile calculates BMI based on weight and height measurements. You cannot enter or adjust BMI values.

## Changing profiles

You can change the active profile on the device to access a different set of features.



**NOTE** "Allow profile change" must be enabled in Advanced settings to change profiles.

The steps to change profiles vary based on several conditions:

- Active versus target profile
- Established patient context
- Saved patient measurement data
- Sensors actively collecting patient measurement data

The following table provides an overview of allowed profile changes based on these conditions.

Conditions under which specific profile changes are allowed				
Active profile	Target profile	Established patient context	Saved patient measurement data	Sensors actively collecting patient measurement data
Continuous Monitoring	Intervals Monitoring or Spot Check	X		
Intervals Monitoring or Spot Check	Continuous Monitoring	X	X	X
Spot Check	Intervals Monitoring	X	X	X

Conditions under which specific profile changes are allowed				
Active profile	Target profile	Established patient context	Saved patient measurement data	Sensors actively collecting patient measurement data
Intervals Monitoring	Spot Check	X	X	X



**NOTE** Confirmation dialogs appear onscreen whenever a specific profile change would erase saved Review tab data, erase episodic patient measurements on the display, or potentially require changes to patient or location context.

## Change from one non-continuous profile to another non-continuous profile

1. Touch the selected profile indicator in the Device Status area.

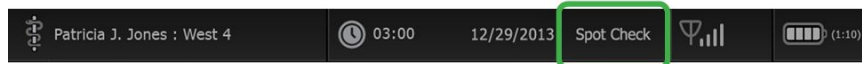

The Profile vertical tab appears.

2. Select the desired profile.

The profile change immediately takes effect.



**NOTE** For all of these non-continuous profile changes, saved episodic patient measurements remain on the Review tab, and current measurements remain onscreen. Patient and/or location context, if established, remain onscreen for all non-continuous profile changes.

## Change to the Continuous Monitoring profile

### Automatic profile change

If "Allow profile change" has been enabled in Advanced settings, the device attempts to change to the Continuous Monitoring profile automatically when a continuous sensor (CO<sub>2</sub>, RRa, EarlySense) is attached to the device. When the profile change occurs, an information message appears in the Device Status area to report that change.



**NOTE** The profile change dialogs described in the following Manual profile change section appear onscreen as appropriate based on established patient context and/or patient measurements on the device.



**NOTE** An automatic change to the Continuous Monitoring profile occurs only once for each continuous sensor attachment. If the attempted profile change fails, or if you switch to an episodic profile after an automatic change to the Continuous Monitoring profile, you must disconnect and then reconnect a continuous sensor for another automatic change to occur.



**NOTE** If the device cannot change to the Continuous Monitoring profile, a dialog indicating that this profile is unavailable in the current configuration appears.

## Manual profile change

To manually change to the Continuous Monitoring profile from any other profile, complete these steps.

1. Touch the selected profile indicator in the Device Status area.

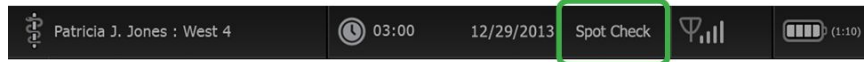

The Profile vertical tab appears. Based on the boldface text presented, select and follow the step and substeps below that apply to your patient and the device.



**NOTE** In addition to all the conditions described in this section, in all cases that involve an already logged-in Clinician, a dialog appears prompting you to confirm that Clinician information will be cleared when changing to the Continuous profile.

2. **When no patient and/or location context are established and no patient measurements have been taken or saved,** select the desired profile.

The profile change immediately takes effect.

3. **When patient and/or location context are established but no patient measurements have been taken or saved:**

- a. Select the desired profile.

A confirmation dialog appears asking you to confirm the patient and/or location context information or select a new patient. For example, if both patient and location context have been established, the following options appear:

- Same patient, same location
- Same patient, different location
- New patient

- b. Select the desired option and touch **OK**.

The profile change immediately takes effect.

4. **When patient and/or location context are established and patient measurements have been taken or saved:**

- a. Select the desired profile.

A confirmation dialog appears with the following message: "Changing to the Continuous Monitoring profile deletes all measurement data from the device. Continue anyway?"

- b. Touch **Yes** to confirm or **No** to cancel the profile change.



**NOTE** Selecting No enables you to send captured vitals data on the device before changing profiles. After you complete that task, if applicable, repeat steps 1 and 4.

A confirmation dialog appears asking you to confirm the patient and/or location context information or select a new patient. For example, if both patient and location context have been established, the following options appear:

- Same patient, same location
- Same patient, different location

- New patient
- c. Select the desired option and touch **OK**.  
The profile change immediately takes effect.
- 5. Touch the **Home** tab.  
You can now start monitoring a patient in the Continuous Monitoring profile.

## Change from the Continuous Monitoring profile

To change from the Continuous Monitoring profile to any other profile, complete these steps.

1. Touch the selected profile indicator in the Device Status area.

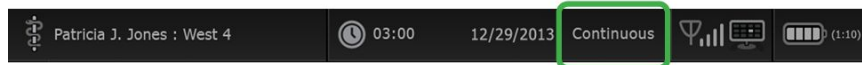

The Profile vertical tab appears. Based on the boldface text presented, select and follow the step and substeps below that apply to your patient and the device.

2. **When no patient trend data has been stored**, select the desired profile.  
The profile change immediately takes effect.
  3. **When continuous sensors are connected to the patient, or when episodic or continuous data has been stored**, no other profile selections are available until you remove patient sensors and end monitoring.
    - a. Remove continuous sensors from your patient.
    - b. On the Settings tab, touch the **Monitor** tab.
    - c. Touch **End monitoring**.  
An "End monitoring" dialog appears with the following options:
      - New patient – Clears patient and location context and review data
      - Power down – Clears patient and location context and review data, and powers down the device
      - Cancel – Retains patient data and returns to Home tab
-  **NOTE** Ending monitoring deletes all patient measurement data from the device.
- d. Select the desired option and touch **OK**.  
The Home tab appears.
  - e. Repeat step 1 and select the desired profile on the Profile vertical tab.  
The profile change immediately takes effect.
  4. **When patient and/or location context are established, but no episodic or continuous trend data has been stored:**
    - a. Select the desired profile.  
A confirmation dialog appears asking you to confirm the patient and/or location context information or select a new patient. For example, if both patient and location context have been established, the following options appear:
      - Same patient, same location
      - Same patient, different location
      - New patient

- b. Select the desired option and touch **OK**.

The profile change immediately takes effect.



**NOTE** If the device was connected to a central station while the Continuous Monitoring profile was active, changing to any other profile disconnects the device from the central station.





## Patient data management

---

Patient demographic data is managed on the Patients tab.

From this tab, you can do the following:

- Retrieve a patient list from the network (for example, electronic medical records (EMR) or a central station).
- Select a patient from the list.
- Manually create patient entries and a patient list.
- Scan a patient ID with the barcode scanner and return a patient name match from your host system.



**NOTE** The patient name match could come from EMR or a central station.

- Enter additional patient information such as manual parameters.
- Assign a patient and location to device only or to a central station during continuous monitoring.



**CAUTION** Verify patient identity on the monitor after manual or barcode entry and before printing or transferring patient records.

## Add a patient to the patient list



**NOTE** If the monitor is configured to retrieve the patient list from the network and is in the Spot Check or Intervals Monitoring profile, you cannot manually add a patient to the patient list.



**NOTE** If the monitor is configured to retrieve the patient list from the central station and is in the Continuous Monitoring profile, you can add a patient to the patient list and transfer it to the central station.

1. Touch the **Patients** tab.
2. Touch **Add**.
3. Touch  and then enter patient information. Touch **Next** to cycle through the patient data fields.



**NOTE** You can use a barcode scanner to enter a patient ID in the Patient ID field. Touch  in the Patient ID field, scan the barcode, and touch **OK**.

4. Touch **OK** to return to the Home tab.

The information is saved.



**CAUTION** Verify patient identity on the monitor after manual or barcode entry and before printing or transferring patient records.

## Load patient data with a barcode scanner

You can use a barcode scanner to query existing patient records and perform a patient name match with the host system.



**NOTE** If the monitor is connected to the network, the monitor can receive a patient name from patient records associated with a scanned ID number.



**NOTE** If "Require patient ID match to save measurements" is enabled in Advanced settings, a progress indicator appears onscreen as the device queries an external host system or the device's Patient list for a matching ID.

- An unsuccessful query results in the message, "Unable to identify patient."
- A successful query results in patient data populating fields and appearing onscreen according to preferences configured in Advanced settings.

1. Ensure that you are on the Home tab.
2. Scan the patient's barcode with the barcode scanner.

The Patient ID appears in the Patient frame if the patient query is successful.



**CAUTION** Verify patient identity on the monitor after manual or barcode entry and before printing or transferring patient records.

## Select a patient

The options for selecting previously stored patients from the List tab vary based on the following conditions:

- Active profile
- Established patient context
- Connection to a network
- Connection to a central station

Based on the boldface text presented, follow the steps below that apply to your patient and the device.

1. **In all profiles, when patient context has not been established on the device and patient type remains the same:**
  - a. Touch the **Patients** tab.  
The List tab appears.

- b. If the monitor is connected to the network, touch **Retrieve list** to update the onscreen patient list.

The monitor retrieves the patient list from the network.



**NOTE** When the monitor is connected to a central station, the monitor retrieves the patient list when you navigate to the Patients tab.

- c. Touch the patient's identifier (name, ID number, or location) you want to select.



**NOTE** Patient data can be sorted in ascending or descending order by selecting the heading row and touching ▲ or ▼. If a sort marker does not appear in a column, touch the heading, and the ▲ appears.

- d. Touch **Select**.

The selected patient's identifier appears on the Home tab.



**NOTE** As long as you make no change to patient type, any displayed patient measurements remain onscreen and are associated with the selected patient, and patient configuration settings are retained.

2. **In the Intervals Monitoring and Spot Check profiles, when patient context has been established on the device and you want to select a different patient (change patient context):**

- a. Touch the **Patients** tab.

The Summary tab appears.

- b. Touch the **List** tab.

- c. If the monitor is connected to the network, touch **Retrieve list** to update the onscreen patient list.

The monitor retrieves the patient list from the network.



**NOTE** You can enable the monitor to retrieve the patient list from the network in Advanced settings. When this feature is enabled, a **Retrieve list** button replaces the **Add** button on the List tab.



**NOTE** When the monitor is connected to a central station, the monitor automatically retrieves the patient list when you navigate to the Patients tab.

- d. Touch the patient's identifier (name, ID number, or location) you want to select.



**NOTE** Patient data can be sorted in ascending or descending order by selecting the heading row and touching ▲ or ▼. If a sort marker does not appear in a column, touch the heading, and the ▲ appears.

- e. Touch **Select**.

The selected patient's identifier appears on the Home tab.



**NOTE** All displayed patient measurements and configuration settings are cleared.

3. **In the Continuous Monitoring profile, when patient context has been established on the device and you want to select a different patient (change patient context), you must end monitoring before selecting/assigning a different patient.**
  - a. Touch the **Settings** tab.  
The Monitor tab appears.
  - b. Touch **End monitoring**.  
An "End monitoring" dialog appears with the following options:
    - New patient – Clears patient and location context and review data after you remove patient sensors
    - Power down – Clears patient and location context and review data, and powers down the device
    - Cancel – Retains patient data and returns to Home tab
  - c. Touch **New patient**.
  - d. Complete step 1.



**NOTE** If patient context has been established and you attempt to select a new patient by navigating to the **List** tab, the device displays the message, "Patient already assigned to device. To assign a different patient, end monitoring for the current patient."

## Office profile

The Office profile supports manual entry of patient information.

Some configurations also enable scanning of patient barcodes. These configurations, specified in Advanced Settings, include the following:

- The "Primary label" setting is Patient ID.
- The "Primary label" setting is Name and the "Search by patient ID" setting is selected.

## Manually enter patient information

In the Office profile, you can manually enter patient information in the Patient frame.

1. From the Home tab, touch the keyboard icon in the Patient frame.

The keyboard appears.

2. Enter patient information. Touch , if displayed, to cycle through the patient data fields.



**NOTE** The "Primary label" setting in Advanced Settings specifies available fields.

3. Touch **OK**.

The information appears in the Patient frame.

4. To change the patient type, touch the patient type button (located on the right side of the Patient frame).



**CAUTION** Verify patient identity on the monitor after manual or barcode entry and before printing or transferring patient records.

## Manage patient records (Continuous Monitoring profile)

In the Continuous Monitoring profile, the Review tab enables access to tabular and graphical trend tables of all readings for the currently selected patient. You can configure the time intervals displayed, and you can scroll through the last 24 hours of patient measurements. Trend data can be printed from this tab.

1. Touch the **Review** tab.



**NOTE** Measurements that triggered a physiological alarm are highlighted on this tab in a color that reflects the alarm condition priority.



**NOTE** Measurements shown with blue highlighting may be inaccurate and should be reassessed.



**NOTE** Measurements with a \* to the right of the value indicate manual overrides of captured measurements.

West 4A		19:31		12/29/2013		Continuous		Signal strength		Battery (1:10)	
Barker, David		14:00	15:00	15:04	16:00	17:00	18:00	18:51	19:00		
IPI		9	10	9	9	9	9	9	10		
RR <small>BPM</small>		15	19	15	15	19	15	19	18		
SpO2 %		97	98	97	97	99	97	85	100		
etCO2 <small>mmHg</small>		46	45	46	46	45	46	45	40		
Pulse rate <small>/MIN</small>		70	68	200	70	64	70	64	71		
NIBP <small>SYS/DIA kPa</small>		122/73		122/73	122/73		122/73	124/82	121/73		

View 1 hour

[Home](#)
[Patients](#)
[Alarms](#)
[Review](#)
[Settings](#)

If your device is configured to monitor patient movement, the Review tab might resemble the following example.

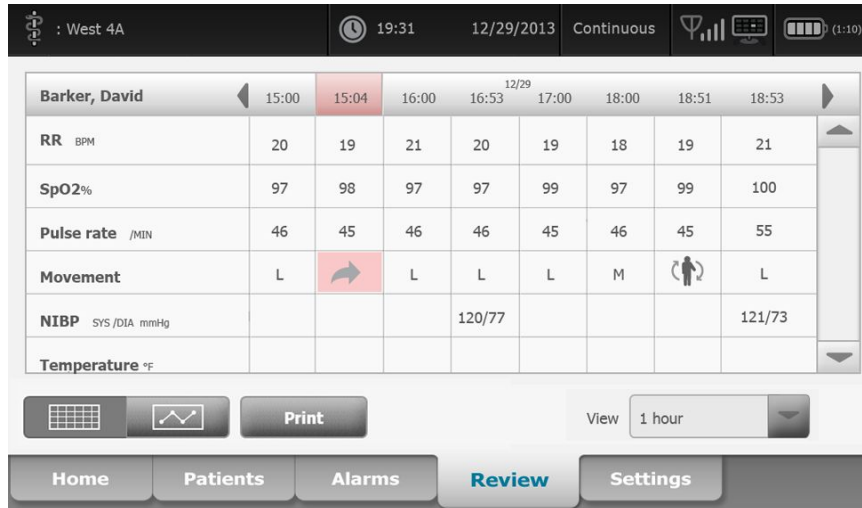

2. Modify the trend interval (the progression of time displayed horizontally in the table) by using the View listbox. Trend interval options are 1, 5, 15, and 30 minutes; 1, 2, 4, or 8 hours; and alarms only. The default trend interval is 1 minute.





**NOTE** Event data (e.g., physiological alarms, patient movement, manual NIBP or temperature measurements, Manual parameter entries) is displayed in all trend intervals. By modifying the trend interval to one of the longer time spans, you can filter out non-alarming, continuous measurements between the currently selected time intervals to focus more attention on event data. Alternatively, you can modify the trend interval by selecting a shorter time span to display a more comprehensive listing of continuous measurements.



**NOTE** Records from the manual episodic save in the Continuous profile cannot be reviewed in the trend table.

3. Use the scroll bar on the right to view patient measurements for any parameters that do not fit in the display area.



4. Touch the page forward  and page backward  controls in the table header to view additional measurements for this patient. The most recent measurements appear on the right of the table, with older measurements to the left.



5. Touch the graphical trends button  to view a graphical representation of patient measurements recorded in the tabular trends table.



6. Touch the tabular trends button  to return to the tabular view.
7. Touch **Print** to print the patient's record.  
A Print options dialog appears.
8. Select the desired Timespan and touch **Print**.



**NOTE** If no patient is selected, the Continuous Monitoring profile is not active, and no measurements have been taken, all table cells in the Review tab remain blank.



**NOTE** In the Continuous Monitoring profile, you cannot delete saved patient measurements. Patient measurements older than 24 hours are automatically deleted from the Review tab.



**NOTE** The date and time stamps on saved patient measurements will adjust in response to new date and time settings.



**NOTE** In the Continuous Monitoring profile, the Send option is not available on the Review tab.

## Manage patient records (Intervals Monitoring, Spot Check, and Office profiles)

Patient records can be sent to the network, printed, or deleted in these profiles.

1. Touch the **Review** tab.

Patricia J. Jones : West 4 03:00 12/29/2013 Intervals (1:10)

<input type="checkbox"/>	Patient name	Date / Time	NIBP	Temp	PR	SpO2	SpHb	Ht	Wt	P	RR
<input type="checkbox"/>	Barker, David A	12/29/2011 11:22	145/100 (101)	100.8	90	99	11.8	54.1	123.5	4/38	
<input checked="" type="checkbox"/>	Smith, David A	12/29/2011 10:00	132/98 (96)	101.1	101	98	12.1	61.2	213.5	5/28	
<input type="checkbox"/>	204 A	12/29/2011 9:31	135/99 (100)	99.8	98	98	13.6	48.7	196.9	1/22	
<input type="checkbox"/>	8704330177	12/29/2011 8:44	120/80 (96)	101.1	97	97	14.9	68.5	271.4	1/28	
<input type="checkbox"/>	Carter, Grace C	12/29/2011 7:55	145/100 (101)	101.1	98	99	15.1	74.1	200	3/23	
<input type="checkbox"/>	Murphy, Michael	12/29/2011 6:58	132/98 (96)	99.8	97	97	16.8	72.4	188.2	8/40	

Send Print Delete View All

Home Patients Alarms **Review** Settings



**NOTE** If your device is configured for Custom scoring, the Review tab might resemble the following example.

Save successful. OK

<input type="checkbox"/>	Patient	Date / Time	NIBP	Temp	PR	SpO2	EWS	Ht	Wt	P	RR
<input type="checkbox"/>	Barker, David	08/31/2018 14:39	250/80( )*	101.0*	75*		8			//	/25
<input type="checkbox"/>											
<input type="checkbox"/>											
<input type="checkbox"/>											
<input type="checkbox"/>											

Send Print Delete View All

Home Patients Alarms **Review** Settings



**NOTE** To see the specific parameters and scores that generated the aggregate score in the EWS column (which could have a different name at your facility), touch the score in that column to open the custom score summary.



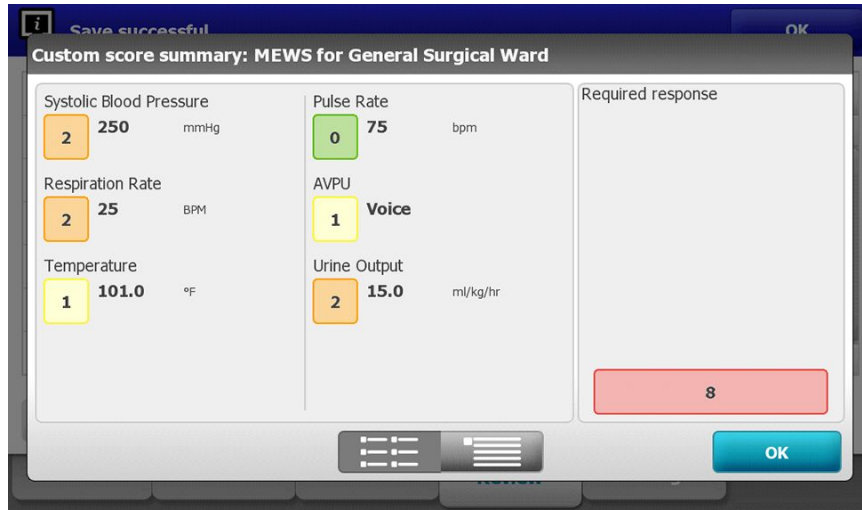

2. Select records by touching the check box.
3. Touch **Send** to transmit the records to the network, **Print** to print the records, or **Delete** to permanently remove the records as desired.



**CAUTION** Verify patient identity on the monitor after manual or barcode entry and before printing or transferring patient records.



**CAUTION** Always visually verify the printed patient records.



**NOTE** The  icon indicates the records have been sent to the network.



**NOTE** You can configure some profiles and settings to automatically send measurements to the network.



**NOTE** Patient measurements older than 24 hours are automatically deleted from the Review tab.



**NOTE** The date and time stamps on saved patient measurements adjust in response to new date and time settings.

## Printer

The monitor prints to a strip to create printouts of patient information and data. Controls in Advanced settings enable you to select what patient information (Name and patient ID, Name only, Patient ID only, None) appears on these printouts.



**NOTE** The sample printouts below are English, but the language in the printouts is defined by the language selected on the monitor.

Patient:				
ID: 13579				
Room/Bed:				
Clinician:				
SYS/DIA (MAP) PR	SpO2	Temp		
(mmHg)	(BPM)	(%)	(°F)	
-----				
12/31/2011 @ 07:46				
78	97			
12/31/2011 @ 07:46				
86/55 (65)	78	97		
12/31/2011 @ 07:46				
110/71 (84)	82	97		
12/31/2011 @ 07:46				
102/63 (76)	78	97		
12/31/2011 @ 07:46				
105/67 (79)	80	96		
12/31/2011 @ 07:46				
100/64 (76)	77	97		

Intervals Monitoring report

Patient:		
ID: 13579		
Room/Bed:		
Clinician:		
12/31/2011 @ 08:53		
SYS	106	mmHg
DIA	68	mmHg
MAP	81	mmHg
PR	71	BPM
SpO2	??	
Temp	97.8	°F
Height	177.8	cm
Weight	68.0	kg
Pain	0	
RR	12	bpm

Spot Check report

Patient:	Page 1	09/11/2012	23:57	23:58	23:59	00:00	00:01	00:02	*	
ID: 13579	-----									*
Type: Adult	NIBP	mmHg	111/69(83)	120/80(90)					*	
Room/Bed: 256 B	SpO2	%	93	100	94	95	96	99	*	
Clinician: 987-65-4321	SpHb	g/dL	10.7	7.4	7.0	7.2	9.3	13.1	*	
	PR	/MIN	58	60	56	71	60	56	*	
	etCO2/FiCO2	mmHg	11(1)	33(0)	35(0)	34(0)	37(0)	38(0)	*	
Vital Signs Table	IPI		9	9	10	9	9	8	*	
09/12/2012 00:02	RR	/MIN	19	13	13	14	15	14	*	
View: 1 min	Temp	°F		98.5					*	
Timespan: 5 min	Weight	lb	168						*	
	Pain		4	10			3		*	

Continuous Monitoring trend data report with capnography

ID: 13579	Page 1	08/06/2013	10:12	10:13	10:14	10:15	10:16	10:17	*	
Type: Adult	-----									*
Room/Bed:	NIBP	mmHg							*	
Clinician:	SpO2	%							*	
	PR	bpm	60	60	40	65	65	65	*	
	Temp	°F							*	
	RR	BPM	12	40	15	15	15	15	*	
	Weight	lb							*	
Vital Signs Table	Pain								*	
08/06/2013 10:17	Movement		L	0	M	Exit	H	EH	*	
View: 1 mins	Trend change					X			*	
Timespan: 1 Hour										*

Continuous Monitoring trend data report with patient movement

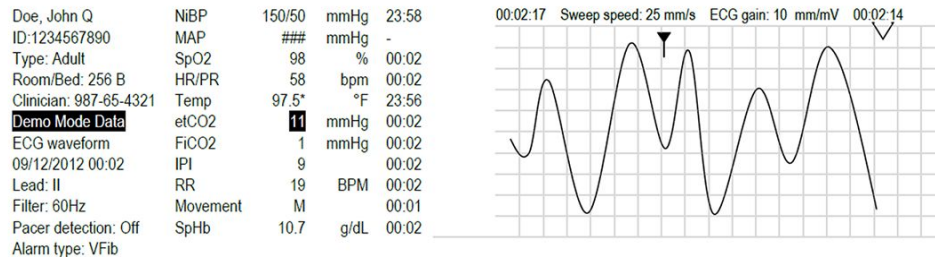

Continuous Monitoring trend data report with ECG

Reading ECG printouts

1. Printouts include a timestamp indicating the absolute time of when the reading was taken.
2. Manual entries include an asterisk (\*) printed to the right of the value.
3. Printouts display "###" to indicate invalid readings. For example, a measured or manually entered vital sign is available for the ECG printout for up to 16 minutes. After 16 minutes, a "###" replaces the vital sign on the printout.
4. Printouts display "??" to indicate unknown readings.
5. Printouts display "++" to indicate overrange readings.
6. Printouts display "--" to indicate underrange readings.
7. Numerics presented in reverse text (white text on a black field) indicate alarming readings.

## Delete a patient from the list

1. Touch the **Patients** tab.
2. From the List tab, touch the patient record you want to delete.
3. Touch **Delete**.

At the Delete Confirmation window, touch **OK** to permanently delete the selected patient. Touch **Cancel** to cancel the deletion.



**NOTE** Deleting a patient from the Patients List does not delete saved records. Touch the **Review** tab to see or delete saved records.



**NOTE** For monitors connected to the network, deleting a patient on the monitor does not affect data on the network.



# Alarms

---

The monitor presents physiological alarms and technical alarms. Physiological alarms occur when vital sign measurements fall outside of set alarm limits, but they occur only in the Continuous Monitoring and Intervals Monitoring profiles. Technical alarms occur when there is a problem with the monitor, an accessory connected to the monitor, or the network. Technical alarms occur in all profiles.

The monitor can communicate alarms to the following external systems:

- Nurse Call systems
- Welch Allyn software systems



**WARNING** The monitor is the primary alarming source for the patient, and any external system (such as a Nurse Call or software system) is a backup alarm source. The external system is only as reliable as its network and can be relied on only as a backup alarming device.



**WARNING** When the monitor is not connected to a secondary alarm system during continuous patient monitoring, check the monitor regularly to receive patient data, alarms, and alerts.



**NOTE** USB is not intended for remote communication of continuous parameters and continuous alarms. Ethernet and wireless are intended for communication of vital signs parameters, patient data, and alarms (including continuous and episodic parameters and alarms) to secondary remote viewing and alarming systems.

## Alarm types

Type	Priority	Color	Alarm audio tone
<ul style="list-style-type: none"> <li>NIBP, SpO2, SpHb, etCO2, respiration, pulse rate, or IPI limit exceeded</li> <li>No breath detected</li> <li>Some technical alarms</li> </ul>	High	Red	10-pulse tone
<ul style="list-style-type: none"> <li>Patient has exited the bed</li> </ul>	High	Red	Alternate 10-pulse tone
<ul style="list-style-type: none"> <li>Temperature or FiCO2 limit exceeded</li> <li>Extremely high motion</li> <li>Some technical alarms</li> </ul>	Medium	Amber	3-pulse tone
<ul style="list-style-type: none"> <li>Some technical alarms</li> </ul>	Low	Amber	2-pulse tone or 1-pulse tone at 30-second intervals
<ul style="list-style-type: none"> <li>Technical alarms that don't impact patient safety</li> </ul>	Very low	Cyan	2-pulse tone or 1-pulse tone at 5-minute intervals

## ECG module alarm types



**WARNING** Patient safety risk. Life-threatening arrhythmias can trigger one of two optional high alarm tones for ventricular tachycardia (V-Tach), ventricular fibrillation (V-Fib), and asystole. If you are monitoring a patient for life-threatening arrhythmias, verify the alarm tone that your facility or floor has chosen.

Type	Priority	Color	Alarm audio tone
<b>Physiological</b>			
<ul style="list-style-type: none"> <li>Asystole</li> <li>Ventricular tachycardia</li> <li>Ventricular fibrillation</li> </ul>	High cardiac	Red	<u>Two available tones</u> Default: IEC 10-pulse tone Standard 10-pulse tone
<ul style="list-style-type: none"> <li>High or low respiration.</li> <li>High or low heart/pulse rate.</li> </ul>	High	Red	10-pulse tone
<b>Technical</b>			
<ul style="list-style-type: none"> <li>Searching for respiration, caused by extended period of no respiration signal</li> </ul>	High	Red	10-pulse tone

Type	Priority	Color	Alarm audio tone
<ul style="list-style-type: none"> <li>Module reports that it is unable to analyze the ECG signal for V-Tach, V-Fib, and/or Asystole (Cannot analyze ECG)</li> <li>In acquisition mode, the ECG has been unable to detect an ECG waveform for the past 30 seconds. (Cannot measure ECG)</li> <li>Module reports that one or more electrodes are off (Electrode(s) off:...)</li> </ul>	Medium	Amber	3-pulse tone
<ul style="list-style-type: none"> <li>In acquisition mode, the ECG module has not transmitted ECG data for the past 30 seconds. (ECG not functional)</li> </ul>	Low	Amber	2-pulse tone or 1-pulse tone at 30-second intervals
<ul style="list-style-type: none"> <li>Data inconsistency (ECG not functional)</li> <li>Sensor errors</li> </ul>	Very low	Cyan	2-pulse tone or 1-pulse tone at 5-minute intervals

## Alarm notification locations on the monitor

Recommended operator position: Stand in front of the device within 1 meter. Face the device with the monitor at an angle that allows you to easily view the screen.



**WARNING** Whenever possible, do not rely on visual alarm notifications alone while monitoring patients. If you must rely on visual alarm notifications, maintain a clear line of sight with the monitor. For audio alarm notifications, set the volume as needed considering the environment and ambient noise levels. Verify that the alarm is audible to a clinician working at the maximum distance from the monitor.



**WARNING** Patient injury risk. If you are relying on visual alarm notifications, maintain a clear line of sight with the monitor and/or Nurse Call. Set the volume as needed considering the environment and ambient noise levels.



**WARNING** Patient injury risk. Do not set the alarm limits to extreme levels, which could render the alarm system useless.

### Nurse Call

In facilities with a Nurse Call system, the monitor immediately notifies the Nurse Call when an alarm occurs. The configuration settings for devices at your facility specify Nurse Call notification settings.

### LED light bar

The light bar on the handle of the monitor illuminates as follows:

- Flashing red for high-priority alarms
- Flashing amber for medium-priority alarms
- Constant amber for low-priority and very low-priority alarms

The light bar darkens when the alarm tone is reset.

## Home tab

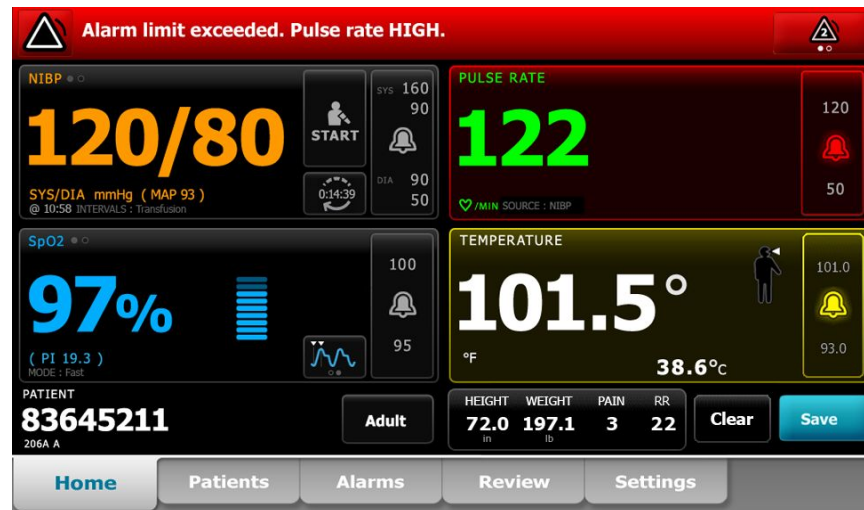

## Home tab notifications

Notification	Description
Device Status area	<p>The area changes color and displays a message with an accompanying status icon or button. If the alarm tone is in a pause interval, a timer countdown appears.</p> <p>If multiple alarms are active, the device provides options to manually toggle or autoscroll through the alarms. You can cycle through each alarm message in sequence of priority by touching the multiple alarm toggle. Alternatively, the autoscroll option displays each alarm message in sequence of priority for approximately 4 seconds, and then loops back to the top priority message. In either option, when multiple alarm messages of the same priority exist at the same time, the device displays the most recent of those alarm messages first.</p> <p>Information messages instruct you to interact with the monitor in a specific way or provide information that does not require action. You can dismiss an information message by selecting the control associated with the message or waiting for the message to time out.</p>
Parameter frame	<p>The background color changes. Touch this area to reset (pause or turn off) the alarm tone.</p> <p> <b>WARNING</b> Do not pause or turn off an audible alarm if patient safety might be compromised.</p> <p>After the tone is reset, visual indicators remain until the condition is corrected, the next measurement is taken, or the alarm is cancelled.</p>
Alarm Limit control	<p>The control appears in each parameter frame.</p> <p>The icon in this control indicates the status of the alarm limit settings. Red and amber icons indicate measurements that have exceeded alarm limits.</p> <p>Touch this control to navigate to a parameter-specific tab where you can modify alarm limit settings. The control also displays alarm limits in some device configurations.</p>



## Icons on the Home tab

### Icons in parameter frames

The icons in the parameter frames indicate alarm notification settings. When alarm limits are on, the icons are black and white until an alarm occurs. Then, the icons change color to indicate the priority of the alarm. Red icons represent high-priority alarms, and amber icons represent medium- or low-priority alarms.

### Icons in parameter frames

Icon	Name and status
	Alarm off. No visual or audio alarms occur for this parameter. You are fully responsible for maintaining awareness of the patient’s condition.
	Alarm on. Audio and visual notifications are enabled.
	Alarm audio off. Only visual notifications occur. If the patient is being monitored continuously, maintain a clear line of sight with the monitor while audio alarms are disabled.
	Alarm audio paused. The audio tone is paused. The icon remains until the paused time counts down to 0.

### Icons in the Device Status area

The icons in the Device Status area are black and white, but the background area changes colors to indicate the alarm priority. Messages accompany these icons. These icons can be controls or status indicators.



### Icons in the Device Status area

Icon	Name and status
	Alarm active. One or more alarms are active. Touch this icon to reset (pause or turn off) the alarm tone.  <b>WARNING</b> Do not pause or turn off an audible alarm if patient safety might be compromised.
	Alarm audio off. Audio signals are disabled, but alarm limits and visual alarm signals remain active.

---

### Icons in the Device Status area

---

Icon	Name and status
	If the patient is being monitored continuously, maintain a clear line of sight with the monitor while audio alarms are disabled.
	Multiple alarms toggle. Touch this icon to cycle through the messages for each active alarm.
	Alarm audio paused. The audio tone is paused. The icon remains until the paused time counts down to 0. Touch this icon to start the user-configured pause interval (set in the Advanced tab).

---

## Patient rest mode

Patient rest mode enables you to turn the audio off and dim the screen of the device when continuous monitoring is enabled and a device is connected to the central station. The visual alarms indication on the device will display, and audible alarms will sound at a compatible Welch Allyn host with visual indications. The device may still be used for additional vitals capture. Touch the screen to remove the dimming while in use. If a loss of connectivity occurs, certain alarms become audible until connectivity is restored.

Patient rest mode can be enabled and disabled from the central station or from the device.

## Patient rest mode location on the monitor

Access the rest mode on the Alarms tab.



**CAUTION** Loss of power will cause the monitor to return to default settings. Each time you power up the monitor, you must set alarm limits appropriate for your patient.

## Turn on patient rest mode

To turn on the patient rest mode from the device:

1. Touch the **Alarms** tab.  
The Alarms screen appears.
2. On the Alarms screen, touch **Patient rest mode on**.  
The patient rest mode is activated.

## Turn off patient rest mode

To turn off the patient rest mode from the device:

1. Touch the **Alarms** tab.  
The Alarms screen appears.

- On the Alarms screen, touch either **Alarm audio on** or **Alarm audio off**.  
The patient rest mode is deactivated.

## Reset (pause or turn off) audio alarms





**WARNING** Do not pause or turn off an audible alarm if patient safety might be compromised.

### Audio alarm characteristics

- After you reset an audio alarm, some tones do not return, but others return after a pause interval if the condition that caused the alarm persists.
- If a new alarm condition occurs during a pause interval, a new audio tone occurs.
- If an audio alarm is not paused or turned off after a period of time, a buzzer accompanies the tone.

### Pause or turn off an audio alarm

- In the Device Status area, touch .
  - Visual indications remain in the parameter frame until the condition is corrected, the next measurement is taken, or the alarm is cancelled.

- In the Device Status area, if the icon changes to  and the message remains, the timer counts down a fixed pause interval of 60 seconds. The alarm tone returns after the pause interval.

A longer pause interval can be configured in the Advanced tab. You start the configured

pause interval by touching .

If you responded to an NIBP alarm and multiple NIBP limits have been exceeded, the alarm tone pauses, the first message clears, and the next NIBP limit message appears with a countdown timer. A new NIBP alarm tone sounds after the countdown unless you touch



to dismiss each remaining NIBP limit message.

- If multiple alarms are active, a multiple alarm toggle appears in the Device Status area. The monitor will either autoscroll through the alarm messages, displaying each for approximately 4 seconds in order of priority, or you can move through the alarms manually. Respond to multiple alarms manually as follows:

- Touch  to pause all audio alarms.

The alarm icon changes to  and the timer counts down a fixed pause interval of 60 seconds. The alarm tone returns after the pause interval.

- b. Touch  in the Device Status area to view each alarm in the stack.



**NOTE** The multiple alarm toggle button displays the number of active alarms inside the alarm icon. A set of dots indicating the display order of alarms from highest (left) to lowest (right) priority (as well as the most recent in the case of multiple alarms of the same priority) appears below it.

## Cancel a paused alarm

You can clear a paused alarm from the Home tab. If the condition that caused the alarm persists, a new alarm appears with visual and audio notification.

1. On the Home tab, touch the alarm limits control in the selected parameter frame.

The Alarms tab for that parameter appears.



2. Touch .

The alarm clears.



3. Touch .

4. Touch the Home tab and confirm that  appears in the parameter frame.

## Adjust vital sign alarm limits

You can adjust vital sign alarm limits or turn off alarm limit checking for individual parameters.



**WARNING** Alarm limits are user-adjustable. For alarms to function properly, you must set or verify alarm limits appropriate for each patient, taking into account the patient's condition and acute care needs. Each time the monitor is powered on, you must check that the alarm settings are appropriate for your patient before you start monitoring.





**CAUTION** Loss of power will cause the monitor to return to default settings. Each time you power up the monitor, you must set alarm limits appropriate for your patient.

1. On the Home tab, touch the alarm limits control in the selected parameter frame. For example,



to adjust the NIBP alarm limits, touch

2. Adjust vital sign alarm limits.
  - To adjust a limit: Enter the desired upper and lower alarm limits using the up/down arrow keys or the keypad.

- To turn alarm limits off or on for the vital sign: Touch  ON OFF or  ON OFF. This button toggles to display the current alarm state.

If you turn off alarm limit checking for a vital sign, no visual or audio alarm signals will

occur for those limits. If alarm limit checking is off, the icon changes to  on the Home tab in the parameter frame.

## Adjust vital sign alarm limits and save settings at startup



**WARNING** Alarm limits are user-adjustable. For alarms to function properly, you must set or verify alarm limits appropriate for each patient, taking into account the patient's condition and acute care needs. Each time the monitor is powered on, you must check that the alarm settings are appropriate for your patient before you start monitoring.



**NOTE** The monitor contains an Advanced tab that provides password-protected access to the monitor's Advanced settings (or Admin mode), enabling nurse administrators, biomedical engineers, and/or service engineers to configure specific features. If the "Enable Save as default" feature is turned off by an administrator, the configuration settings that you have changed cannot be saved at the next startup. To save the vital sign alarm limits configuration settings when the "Enable Save as default" feature is turned off, contact your administrator or consult your facility's protocols and standards or local regulations.

You can adjust vital sign alarm limits for individual parameters. This method also ensures that any configuration settings you have changed and saved will be maintained at the next startup.

1. On the Home tab, touch the alarm limits control in the selected parameter frame. For example,



to adjust the NIBP alarm limits, touch

2. To adjust a limit, enter the desired upper and lower alarm limits using the up/down arrow keys or the keypad.
3. Repeat the process as needed for each parameter.
  - a. When the alarm limits for all parameters are set, touch **Settings**.
  - b. Touch **Device**.
  - c. Touch **Defaults**.
  - d. Touch **Save as default**.

At the *Save as default* confirmation dialog, confirm the new default device settings and touch **OK**. You can power cycle the monitor to verify the newly saved alarm limits remain in effect.

## Reset alarm limits to the factory default settings

In the Continuous Monitoring and Intervals Monitoring profiles, you can modify the alarm limits for individual parameters for each patient, and you can also reset alarm limits to the factory default settings.



**WARNING** Alarm limits are patient-specific. For alarms to function properly, you must set or verify alarm limits appropriate for each patient. Each time the monitor is powered on, you must check that the alarm settings are appropriate for your patient before you start monitoring.

As you are working in the Alarms tab, parameter measurements appear across the top of the tab.

1. Touch the **Alarms** tab.
2. Touch **Reset alarm limits** to set all upper and lower alarm limits and their On and Off states to the factory default settings.



**NOTE** Touching Reset alarm limits on the Alarms tab, only resets the alarm limits for the current monitoring session.

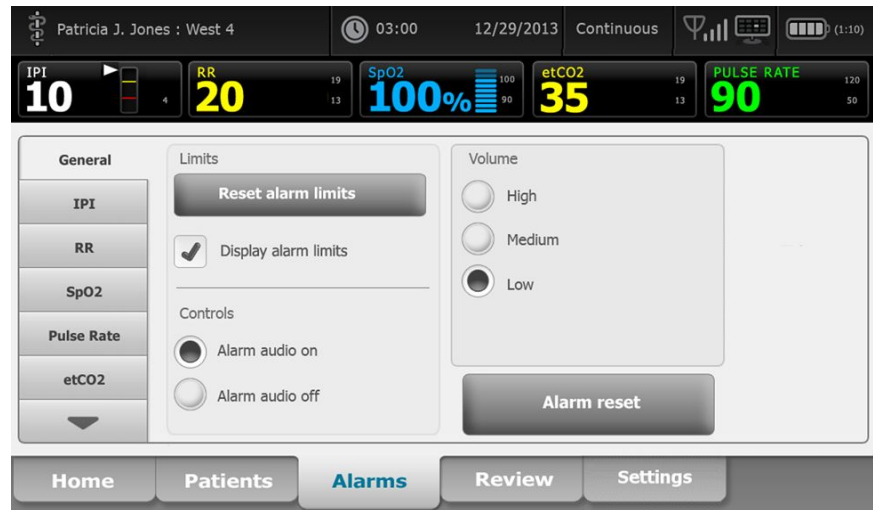

3. To enable or disable the display of alarm limit values, select or deselect **Display alarm limits**.
  - When disabled, alarm limit values are not displayed on the Home tab and only the alarm icon appears within the alarm buttons.
  - When enabled, alarm limit values are displayed on the Home tab within the alarm buttons

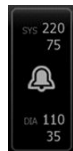

## Adjust ECG and Impedance Respiration alarm limits

You can adjust vital sign alarm limits or turn off alarm limit checking for individual parameters.



**WARNING** Alarm limits are patient-specific. For alarms to function properly, you must set or verify alarm limits appropriate for each patient. Each time the monitor is powered on, you must check that the alarm settings are appropriate for your patient before you start monitoring.



**CAUTION** Loss of power will cause the monitor to return to default settings. Each time you power up the monitor, you must set alarm limits appropriate for your patient.

1. On the Home tab, touch the alarm limits control in the selected parameter frame. For example,



to adjust the ECG alarm limits, touch

2. Adjust vital sign alarm limits.
  - To adjust a limit: Enter the desired upper and lower alarm limits using the up/down arrow keys or the keypad.



- To turn alarm limits off or on for the vital sign: Touch **ON OFF** or **ON OFF**. This button toggles to display the current alarm state.

If you turn off alarm limit checking for a vital sign, no visual or audio alarm signals will



occur for those limits. If alarm limit checking is off, the icon changes to  on the Home tab in the parameter frame.

3. Repeat the same steps in the Respiration Rate (RR) frame to adjust Impedance Respiration alarm limits.

## Modify audio alarm notification

You can modify the volume of all audio alarms.



**NOTE** If the *Allow user to turn off general audio* option is selected in Advanced settings, you can turn off audio alarms. Whenever possible, however, do not rely on visual alarm notifications alone while monitoring patients. If the patient is being monitored continuously, maintain a clear line of sight with the monitor while audio alarms are disabled.



**WARNING** If you are relying on audio alarm notifications, set the volume as needed considering the environment and ambient noise levels. Verify that the alarm is audible to a clinician working at the maximum distance from the monitor.

As you are working in the Alarms tab, parameter measurements appear across the top of the tab.

1. Touch the **Alarms** tab.

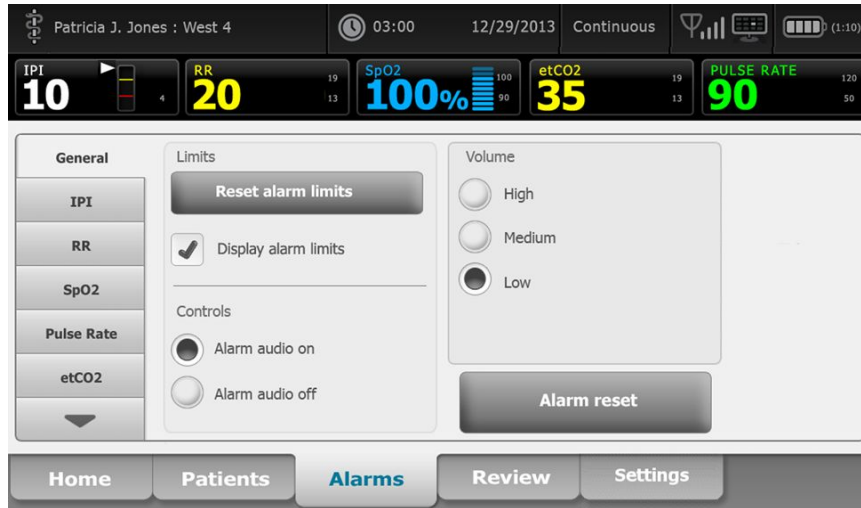

- On the **General** tab, modify audio alarm notification.
  - To enable or disable audio alarms, select **Alarm audio on** or **Alarm audio off**.

If you turn off audio alarms, visual alarm signals still occur in the LED light bar, Device Status area, and on the Home tab in parameter frames.



The  in the Device Status area indicates alarm audio turned off, and a similar bell



appears in the parameter frames. If an alarm condition occurs, the bell is red or



amber in the alarming frame, according to the priority of the alarm, as shown here:

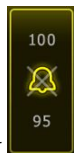

or

- To modify the volume of audio alarms: Select a volume level. An audio tone sounds briefly to indicate the volume level.

## Alarm messages and priorities

The following tables list the physiological and technical alarm messages and their priority.

### Physiological alarms



<b>Alarm messages</b>	<b>Priority</b>
Alarm limit exceeded. etCO2 HIGH.	High
Alarm limit exceeded. etCO2 LOW.	High
Alarm limit exceeded. FiCO2 HIGH.	Medium
Alarm limit exceeded. IPI LOW.	High
No breath detected. Exceeded time limit since last breath.	High
Alarm limit exceeded. Respiration HIGH.	High
Alarm limit exceeded. Respiration LOW.	High
Alarm limit exceeded. NIBP systolic HIGH.	High
Alarm limit exceeded. NIBP systolic LOW.	High
Alarm limit exceeded. NIBP diastolic HIGH.	High
Alarm limit exceeded. NIBP diastolic LOW.	High
Alarm limit exceeded. NIBP MAP HIGH.	High
Alarm limit exceeded. NIBP MAP LOW.	High
Alarm limit exceeded. SpO2 HIGH.	High
Alarm limit exceeded. SpO2 LOW.	High
Alarm limit exceeded. SpHb HIGH.	High
Alarm limit exceeded. SpHb LOW.	High
Alarm limit exceeded. Pulse rate HIGH.	High
Alarm limit exceeded. Pulse rate LOW.	High
Alarm limit exceeded. Temperature HIGH.	Medium
Alarm limit exceeded. Temperature LOW.	Medium
Extremely high motion.	Medium
Heart/Pulse rate HIGH.	High
Heart/Pulse rate LOW.	High
Respiration HIGH.	High
Respiration LOW.	High
Asystole detected.	High cardiac

<b>Alarm messages</b>	<b>Priority</b>
Ventricular tachycardia detected.	High cardiac
Ventricular fibrillation detected.	High cardiac

## Technical alarms

<b>Alarm messages</b>	<b>Priority</b>
Low battery 5 minutes or less remaining.	High
Searching for SpO2 signal.	High
Communications module did not power on properly. Power down the device.	High
Check for occlusion in gas line.	High
Network not found; check network cable connection.	Very low
Battery is absent or faulty.	Very low
Battery is absent or faulty. Call for service.	Very low
NIBP air leak; check cuff and tubing connections.	Very low
NIBP not functional. Call for service.	Very low
Unable to determine NIBP; check connections and tubing for kinks.	Very low
Incorrect NIBP cuff size; check patient type.	Very low
Inflation too quick; check NIBP cuff and tubing connections.	Very low
Unable to determine NIBP; check connections; limit patient movement.	Low
Unable to determine NIBP; check inflation settings.	Low
SpO2 not functional. Call for service.	Very low
Attach SpO2 sensor to monitor.	Very low
Replace the SpO2 sensor.	Very low
Set date and time.	Very low
Maximum number of patient records saved. Oldest record overwritten.	Very low
Connect temperature probe.	Very low
Insert correct color-coded probe well.	Very low
Replace temperature probe.	Very low

<b>Alarm messages</b>	<b>Priority</b>
Temperature not functional. Call for service.	Very low
Retry temperature measurement.	Very low
Temperature time limit exceeded. Retry temperature measurement.	Very low
Low battery, unable to print; plug into outlet.	Very low
Printer door is open; close to continue.	Very low
Printer not functional. Call for service.	Very low
Out of paper.	Very low
Printer too hot; wait to retry.	Very low
Radio not functional. Call for service.	Medium
Radio error. Power down and restart.	Very low
Radio error. The radio has restarted.	Very low
Unable to establish network communications. Radio out of network range.	Very low
Unable to establish network communications. Call for service.	Very low
Radio software upgrade failed.	Very low
Unable to load configuration; using factory defaults.	Very low
Functional error. Call for service.	Very low
External device not recognized.	Very low
Incompatible Welch Allyn device.	Very low
USB Communication failure. Call for service.	Very low
Low battery 30 minutes or less remaining.	Very low
Low SpHb signal quality. Check sensor.	Very low
Low SpO2 signal quality. Check sensor.	Very low
Low perfusion. Check sensor.	Very low
Replace the SpO2 cable.	Very low
SpO2 mode only. Check sensor or cable.	Very low
SpO2 sensor expires in....	Very low
Unexpected restart occurred. Call for service.	Very low

<b>Alarm messages</b>	<b>Priority</b>
Weight scale not functional. Call for service.	Very low
CO2 not functional. Call for service.	Very low
Filter line disconnected.	Very low
CO2 module temperature is out of range. CO2 might not be accurate.	Very low
Purging filter line.	Very low
Calibration is overdue. CO2 might not be accurate.	Very low
Factory service is overdue. CO2 might not be accurate.	Very low
CO2 auto-zero in progress.	Very low
Respiratory freshness timeout expired.	Very low
Replace RRA sensor.	Very low
RRA background interference detected.	Very low
RRA patient interference detected.	Very low
File system formatted on first-time startup.	Very low
Lost connectivity with host.	Low
The patient has exited bed.	High
Patient turn overdue.	Very low
EarlySense not functional.	Very low
The sensor has expired.	Very low
The sensor is defective.	Very low
Replace the bed sensor.	Very low
The bed sensor is disconnected.	Very low
The bed sensor is upside down.	Very low
Bed sensor expires in <"1 month", "1 week", "1 day", "x hours">	Very low
Cannot measure patient. Lost or unstable signal.	Very low
Cannot measure respiration.	High
Cannot measure pulse rate.	High
Trend change detected. Review patient history.	Very low

Alarm messages	Priority
Time limit exceeded. Unable to complete program.	Low
Searching for respiration.	High
ECG not functional.	Low or Very low
Electrodes off:	Medium
Cannot analyze ECG.	Medium
Cannot measure ECG.	Medium
Configuration is invalid without certificates. Reconfigure and try again.	Very low
Failed to authenticate to server.	Very low

## Nurse call

The monitor can be connected to a Nurse Call system through a cable that connects to the Nurse Call connector.

When the Nurse Call cable is connected and Nurse Call is enabled, the monitor notifies the Nurse Call system when an alarm that exceeds the preset threshold occurs. Nurse Call notification persists until one of the following occurs on the monitor:

- The alarm clears.
- You reset (pause or turn off) the alarm tone.

For paused alarms, Nurse Call notification returns after the pause interval if the condition that caused the alarm persists.

Nurse Call thresholds are set in the Advanced Settings.

To connect the monitor to a Nurse Call system, you must have a cable that has been adapted to your Nurse Call system (REF 6000-NC), rated 50V DC maximum at 500mA (DC or ACRMS). For ordering information, see *Approved Accessories* in the Appendix.



**WARNING** The monitor is the primary alarming source for the patient, and any external system (such as a Nurse Call or software system) is a backup alarm source. The external system is only as reliable as its components (e.g., wiring, hardware, light bulbs, connections) and can be relied on only as a backup alarming device.



## Patient monitoring

---

This section of the instructions for use describes the parameters available on the device, how to modify settings and alarm limits for those parameters, and how to take parameter measurements.

Before focusing on each parameter, the section addresses features that generally apply to the parameters on your device: standard and custom modifiers, and manual overrides.



**WARNING** When the monitor is not connected to a secondary alarm system during continuous monitoring, check the monitor regularly to receive patient data, alarms, and alerts.



**WARNING** Whenever possible, do not rely on visual alarm notifications alone while monitoring patients. If you must rely on visual alarm notifications, maintain a clear line of sight with the monitor. For audio alarm notifications, set the volume as needed considering the environment and ambient noise levels. Verify that the alarm is audible to a clinician working at the maximum distance from the monitor.

## Configuration tool

The configuration tool is a web-based tool that enables you to set the device settings for your facility. For more information, contact your sales representative.

## Standard and custom modifiers

Modifiers enable you to save additional information for the measurements for a specific patient. Standard modifiers are the same on all devices. Custom modifiers are specific to a facility or a unit, and they are set up during the initial configuration of your site.

Both standard and custom modifiers appear on the **Patients > Manual** tab.

## Enter modifiers

Follow these steps to enter standard and custom modifiers.

1. Touch the **Patients** tab.
2. Touch the **Manual** tab.
3. Scroll through the list to find the parameter(s) you want to modify, then enter or select the modifier(s) as desired.
4. Touch **OK**.

The Home tab appears. In the Continuous Monitoring profile, the modifiers are saved with the next set of measurements sent to the network. In the episodic profiles, the modifiers are saved with the next set of measurements you take or with any current, unsaved measurements on the device when you touch **Save**.

## Custom scoring

Custom scoring enables you to configure your device to generate custom scores for specific parameters based on your facility's standards. The device supports both single parameter and aggregate scores, as well as messages to accompany both. These scores and messages are provided only as reminders of a patient's condition. You can configure multiple scoring systems that include several parameters as well as customized protocols to generate custom scores.



**WARNING** Risk to patient safety. Custom scores and messages serve as guides to your facility's protocols; **do not substitute custom scores for patient physiological alarms**. Appropriate alarms settings must be set and maintained to ensure patient safety.

To access these configurable parameters, protocols, and custom scoring options on your device, touch the Manual parameters frame just right of center near the bottom of the Home tab.

## Manual overrides

The manual override feature enables you to do the following:

- input measurements when none have been recorded on the device
- replace the currently displayed measurements with measurements you take manually

## Enter a manual override measurement

Follow these steps to enter a manual measurement.

1. Press and hold the selected parameter frame until a keypad appears.
2. Enter the manually acquired measurement on the keypad and touch **OK**.

The Home tab appears and displays the entered measurement.



**NOTE** Touch **Clear** to remove all values and correct your entry as needed.



**NOTE** In the Continuous Monitoring profile, measurements entered manually remain on the screen for one minute. In the episodic profiles, the manual measurement remains in the frame until the next measurement is taken.

## Patient movement

Monitors configured with the EarlySense™ module continuously monitor patient movement, as well as Respiration rate (RR) and Pulse rate if licensing is enabled for these functions.





**NOTE** Respiration rate and Pulse rate measurements taken by the EarlySense module are displayed in the RR and Pulse rate frames, respectively. The frame remains blank until the sensor acquires its first measurements, which could take 1 to 2 minutes. After the initial measurement, a process indicator appears in the frame if a lost or low signal condition occurs. Lost or low signal conditions that last more than 3 minutes trigger an alarm. See the Respiration rate and Pulse rate sections of this instructions for use for more information.



**NOTE** Monitors configured with EarlySense cannot be configured with Masimo rainbow Acoustic Respiration (RRa) or Oridion Microstream capnography.



**NOTE** Patient movement monitoring is not available for neonatal/infant patients.



**NOTE** The EarlySense system has not been studied on any specific patient group, nor has it been studied as a tool to diagnose any specific disease of medical condition. It is an adjunctive tool used to measure respiratory rate, pulse rate, and patient movement.

## Movement frame

The Movement frame displays the following data and controls used to monitor patient movement:

- Patient motion level
- Exit sensitivity
- Movement-related alarm conditions
- Patient turn events and status (time overdue or time remaining until next scheduled turn)
- Sensor source indicator



The size of the Movement frame and displayed data varies based on your configuration.

If the patient turn reminder is active, the timer counts down to zero and then displays a reminder in the Device Status area to perform and log a patient turn. If a scheduled patient turn remains overdue, a "Patient turn overdue" alarm message appears in the Device Status area, and the patient

turn control is highlighted based on the priority of the alarm (for example,  indicates a very low alarm). The timer displays a negative time until the next patient turn or the timer reaches -99:59.

## Exit alarm view

The Exit alarm view is displayed automatically when an exit alarm is triggered. An exit graphic replaces the movement level and exit sensitivity indicators in the frame. The entire frame and alarm icon are highlighted based on the priority of the exit alarm.

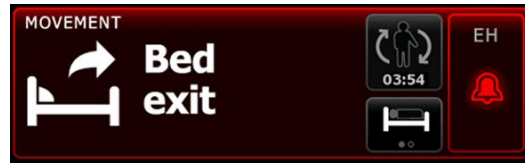

## Set up movement

The Movement vertical tab (**Settings > Setup > Movement**) presents information on the status of sensors. Only alarm settings and modifiers can be changed for this parameter. See "Configure movement alarms" to adjust alarm settings. Follow these steps to set up movement modifiers, if applicable.

1. Touch the **Patients** tab.
2. Touch the **Manual** tab.
3. Scroll through the list to find the Movement section, then enter or select the Movement modifier(s) as desired.



**NOTE** If no modifiers are associated with this parameter, no Movement section will appear.

4. Touch **OK**.

The Home tab appears. In the Continuous Monitoring profile, the modifiers are saved with the next set of measurements sent to the network.

## Configure movement alarms and patient turn reminder

Follow these steps to set alarm limits for patient movement.

1. Verify that you are using the Continuous Monitoring profile.



**NOTE** If "Allow profile change" is enabled in Advanced settings, the device attempts to shift automatically to the Continuous Monitoring profile when you connect the sensor cable.

2. Touch the **Alarms** tab.
3. Touch the **Movement** vertical tab.
4. Ensure that the Exit alarm and Motion alarm controls are set to ON.



**NOTE** If any parameter's alarm limit control is set to OFF, you cannot adjust alarm limits on the Alarm tab, and no visual or audio signals occur for that specific parameter.

5. Adjust the following settings as desired:
  - **Exit sensitivity.** Use the up/down arrow keys or the keypad to choose a sensitivity level ranging from 1 to 6. Setting 1 is the least sensitive, and setting 6 is the most sensitive.



**NOTE** Levels 5 and 6 are highly sensitive and might trigger an alarm as a result of minimal movement while the patient is in bed. Correct patient assessment is the key to minimize false alerts.

- **Turn reminder.** Select the desired turn schedule from the list box.
6. Touch the **Home** tab.

The new alarm settings take effect immediately.

## Monitor patient movement



**WARNING** Patient safety risk. Do not use heating blankets. Heating blankets could reduce the safety and efficacy of the system and void the warranty.



**WARNING** Patient safety risk. The EarlySense system is not intended for high-risk patients in coronary or respiratory distress who require continuous monitoring of heart function or CO<sub>2</sub>. For these patients, the most reliable method of patient monitoring involves close personal surveillance and/or equipment suited to that type of monitoring.



**WARNING** Patient injury risk. The patient should not have direct contact with the bed sensor. A mattress, mattress pad, or mattress cover should always be placed as a barrier between the sensor and the patient. Check patients regularly to ensure that direct contact with the sensor does not occur.



**WARNING** Patient safety risk. Provide careful oversight when the EarlySense System is used with children.



**CAUTION** Sensor malfunction risk. Do not use EarlySense with patients who weigh more than 200 kg (440 pounds).



**CAUTION** Sensor malfunction or inaccurate measurement risk. Patients should not share a bed with another person during EarlySense monitoring.



**CAUTION** Inaccurate measurement risk. The quality of measurements might be affected by cable lengths. Do not shorten or extend the cable.



**CAUTION** Sensor malfunction risk. Do not allow patients to jump on the bed or the bed sensor.



**CAUTION** Sensor malfunction risk. For patients with poor bladder function or control, take care when placing the bed sensor under the mattress, mattress pad, or mattress cover to prevent urine from contacting the sensor.



**CAUTION** Sensor malfunction risk. Do not create sharp bends in the cable to prevent tearing or breaking the shielding.

1. Verify that you are using the Continuous Monitoring profile.



**NOTE** If "Allow profile change" is enabled in Advanced settings, the device attempts to shift automatically to the Continuous Monitoring profile when you connect the sensor cable.

2. Touch the patient type control on the right side of the Patient frame.

The Patient Summary tab appears.

3. Select the patient type, then touch **OK**.



**NOTE** Patient movement monitoring is not available for neonatal/ infant patients.

4. If sensor is not plugged into the device, align the EarlySense cable connector with one of the EarlySense ports on the right side of the monitor. Insert the cable connector until it clicks into place. Also check the stress relief connector on the cable to ensure that both parts of the cable are tightly connected.

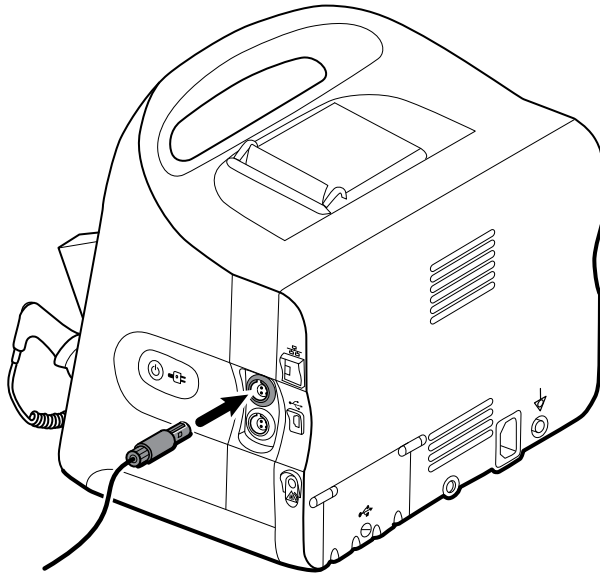

5. Position the bed sensor (sensing unit) as follows:
  - horizontally under the patient's mattress
  - the top surface of the sensing unit facing the mattress
  - the sensing unit under the patient's chest area
  - the sensing unit cable extending toward the head of the bed

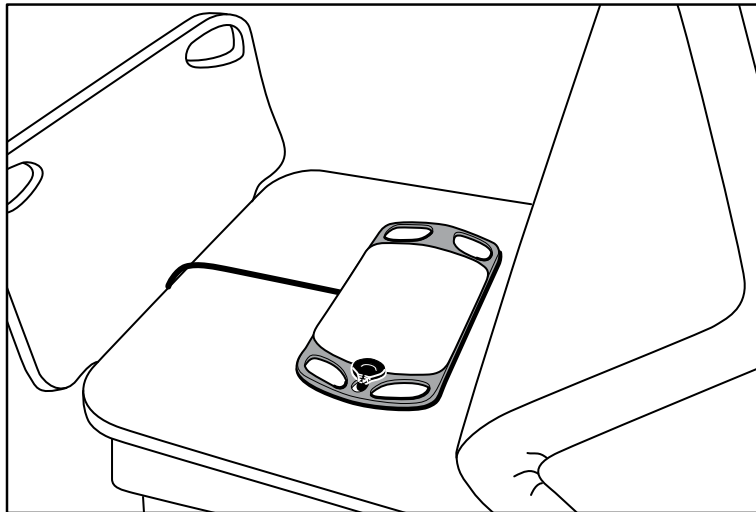

6. Instruct or assist the patient to lie down in bed. Double-check the position of the patient and the sensor (see step 5), and adjust as needed.



**NOTE** Careful placement of the sensor is key to getting quality EarlySense measurements.

7. Wait for a first measurement.



**NOTE** Patient movement, Respiration rate, and Pulse rate measurements taken by EarlySense are displayed in the Movement, RR, and Pulse rate frames, respectively. Each frame remains blank until the sensor acquires its first measurements, which could take approximately 1 to 2 minutes. After the sensor detects a patient, an initial set of measurements appears in the associated frames.



**NOTE** EarlySense alarms occur only after a good initial measurement.

## Low confidence condition

After receiving a valid set of measurements for a specific patient, a low confidence condition occurs whenever the EarlySense module loses or has difficulty acquiring a signal. During low confidence



conditions, a process indicator replaces the previous reading in the Respiration rate (RR) and/or Pulse rate frames and remains in the frame until the sensor acquires a valid measurement.



**NOTE** A low confidence condition that persists beyond 3 minutes triggers a technical alarm.

## Observe and report patient turn events

Based on the Turn reminder schedule configured on the **Alarms > Movement** tab, the patient turn countdown timer indicates the time remaining until the next scheduled turn. If turn reminders have been turned off, the patient turn control is disabled and the counter is blank.

Any time the patient turn button is active and the timer is running, you can report a patient turn on the device. You do not have to wait for the timer to expire.

1. On the Home tab, touch **Pause**.



**NOTE** Putting the device in Pause mode prevents triggering a bed exit alarm.

2. Turn the patient.
3. Touch **Resume monitoring**.



**NOTE** The Home tab appears.

4. Touch 

The patient turn button is disabled, and the following confirmation appears in the Device Status area: "Patient turn logged and counter reset."

The patient turn button remains disabled until the updated turn status is recorded.

## Capnography (CO<sub>2</sub>)

Monitors configured with Oridion Microstream capnography continuously measure or indicate the following:

- End-tidal CO<sub>2</sub> (etCO<sub>2</sub>): the level of CO<sub>2</sub> in a patient's exhaled breath
- Fraction of inspired CO<sub>2</sub> (FiCO<sub>2</sub>): the level of CO<sub>2</sub> in a patient's inhaled breath
- Respiration rate (RR)
- Integrated Pulmonary Index (IPI): a numerical value that integrates four parameters (etCO<sub>2</sub>, respiration rate, SpO<sub>2</sub>, and pulse rate) and indicates a patient's overall respiratory status



**NOTE** Monitors configured with Oridion Microstream capnography cannot be configured with Acoustic Respiration (RRa).

### etCO<sub>2</sub> frame

The etCO<sub>2</sub> frame displays data and controls used in monitoring the level of CO<sub>2</sub> in a patient's breath (etCO<sub>2</sub> and FiCO<sub>2</sub>). Controls to pause or restart the CO<sub>2</sub> pump as well as to pause CO<sub>2</sub> alarms also appear in the frame.



**NOTE** CO<sub>2</sub> monitoring is available only with the Continuous Monitoring profile.

The frame provides a numeric view and a waveform view of CO<sub>2</sub> data. You can toggle between views by touching the left side of the frame.

### etCO<sub>2</sub> numeric view

The numeric view displays end-tidal CO<sub>2</sub> (etCO<sub>2</sub>) and fraction of inspired CO<sub>2</sub> (FiCO<sub>2</sub>) in mmHg or kPa. The size of the etCO<sub>2</sub> frame and displayed measurements varies based on your configuration.



### CO<sub>2</sub> waveform view

The CO<sub>2</sub> capnogram waveform view displays the CO<sub>2</sub> waveform, enabling you to observe a patient's breathing patterns and to determine adequate, hyperventilation, or hypoventilation conditions.

The size of the etCO<sub>2</sub> frame and displayed measurements varies based on your configuration.



### Set up etCO<sub>2</sub>

Follow these steps to configure etCO<sub>2</sub> parameter settings and to set up etCO<sub>2</sub> modifiers.

1. Touch the **Settings** tab.
2. Touch the **Setup** tab.
3. Touch the **etCO2** vertical tab.
4. Adjust the following settings as desired:
  - Sweep speed. Select the desired speed. You can set the default in Advanced settings.
  - Waveform scale. Select the scale using the toggle button. You can set the default in Advanced settings.
  - Pump standby time. Select the time using the toggle button.
5. Touch the **Home** tab.  
The new settings take effect immediately.
6. To set up modifiers, if applicable, touch the **Patients** tab.
7. Touch the **Manual** tab.
8. Scroll through the list to find the etCO2 section, then enter or select the etCO2 modifier(s) as desired.



**NOTE** If no modifiers are associated with this parameter, no etCO2 section will appear.

9. Touch **OK**.  
The Home tab appears. In the Continuous Monitoring profile, the modifiers are saved with the next set of measurements sent to the network.

## Configure etCO2 and FiCO2 alarms

Follow these steps to set alarm limits for CO2 measurements.



**NOTE** FiCO2 appears only if enabled in Advanced settings.

1. Verify that you are using the Continuous Monitoring profile.



**NOTE** If "Allow profile change" is enabled in Advanced settings, the device attempts to shift automatically to the Continuous Monitoring profile when you connect the sensor cable.

2. Touch the **Alarms** tab.
3. Touch the **etCO2** vertical tab.
4. Ensure that the etCO2 and FiCO2 alarm limit controls are set to ON.



**NOTE** If any parameter's alarm limit control is set to OFF, you cannot adjust alarm limits on the Alarm tab, and no visual or audio signals occur for that specific parameter.

5. Adjust the following settings as desired:
  - etCO2 limits. Enter upper and lower alarm limits for etCO2 using the up/down arrow keys or the keypad next to the Limits control.
  - FiCO2 limit. Enter the desired upper alarm limit for FiCO2, if activated, using the up/down arrow keys or the keypad next to the FiCO2 control.
  - High alarm delay. For etCO2 only, select the duration using the list box. This alarm delay specifies the minimum duration of a high alarm condition to activate an alarm signal. You can set the default in Advanced settings.

6. Touch the **Home** tab.  
The new alarm settings take effect immediately.

## Measure CO2

Before you begin, read the Microstream CO2 sampling line's instructions for use.



**WARNING** Loose or damaged connections can compromise ventilation or cause an inaccurate measurement of respiratory gases. Securely connect all components and check connections for leaks according to standard clinical procedures.



**WARNING** When using a sampling line for intubated patients with a closed suction system, do not place the airway adapter between the suction catheter and endotracheal tube. This is to ensure that the airway adapter does not interfere with the functioning of the suction catheter.



**WARNING** Do not cut or remove any part of the sampling line. Cutting the sampling line could lead to erroneous readings.



**WARNING** Inaccurate measurement or equipment malfunction risk. If too much moisture enters the sampling line (e.g., from ambient humidity or breathing unusually humid air), the message "Purging filter line" will appear in the Device Status area. If the sampling line cannot be cleared, the message "Check for occlusion in gas line" appears. Replace the sampling line when this message appears.



**WARNING** The sampling line might ignite in the presence of O2 when directly exposed to lasers or high heat. When performing head and neck procedures involving lasers or high heat, use with caution to prevent combustion of the sampling line or surrounding surgical drapes.



**WARNING** Microstream CO2 sampling lines are designed for single patient use and are not to be reprocessed. To prevent damage to the monitor, do not attempt to clean, disinfect, or blow out the sampling line. Reprocessing or reusing CO2 sampling lines could cause cross-contamination and inaccurate readings.



**CAUTION** Only use Welch Allyn-approved CO2 sampling lines to ensure the monitor functions properly.



**CAUTION** Dispose of Microstream CO2 sampling lines according to standard operating procedures or local regulations.

1. Touch the patient type control on the right side of the Patient frame.  
The Patient Summary tab appears.
2. Select the patient type, then touch **OK**.
3. Select the appropriate sampling line based on the following considerations:
  - Whether the patient is intubated or non-intubated
  - Whether the patient is on mechanical ventilation
  - Duration of use
  - Patient's size and weight
4. Connect the sampling line to the monitor.
  - a. Slide open the door that protects the sampling line port on the monitor.
  - b. Connect the sampling line.





**NOTE** The CO<sub>2</sub> pump starts as soon as the pump sensor recognizes the sampling line. This can occur before you completely connect the sampling line.

- c. Turn the connector completely to the right until tight.

An etCO<sub>2</sub> sampling line dialog appears on the screen to reinforce this instruction (unless the dialog is disabled in Advanced settings).



**WARNING** You must connect the sampling line correctly. Ensure that the connector is tight to accurately monitor CO<sub>2</sub>.



**WARNING** Cross-contamination and nosocomial infection risk. The CO<sub>2</sub> sampling exhaust port, located just below the sampling line connection port, is for respiratory exhaust only. Maintain an open breathing circuit by leaving this port open to vent respiratory gases. Do not attach tubing or reconnect it in any way to the patient's breathing circuit.

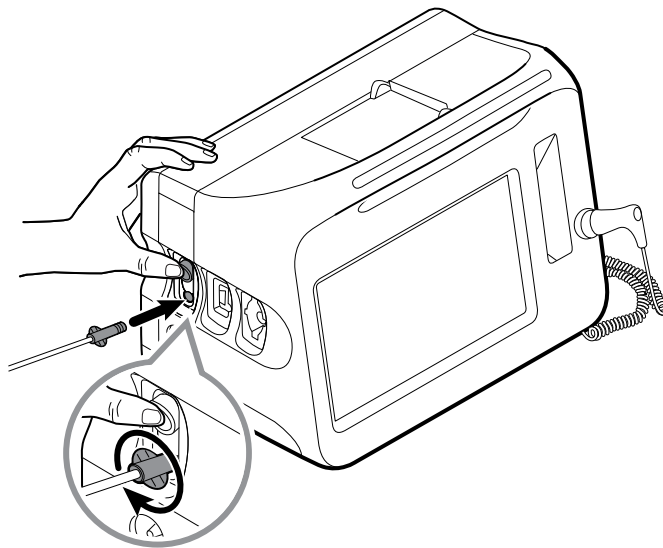

**NOTE** This secure connection prevents gases from leaking at the connection point during measurement and is essential to ensure accurate measurements.

5. If the etCO<sub>2</sub> sampling line dialog appears on your screen, watch the animation and confirm that you have connected the sampling line correctly, then touch **OK** to dismiss the dialog.
6. Verify that you are using the Continuous Monitoring profile.



**NOTE** If "Allow profile change" is enabled in Advanced settings, the device attempts to shift automatically to the Continuous Monitoring profile when you connect the sensor cable.

7. Connect the sampling line to the patient as described in the instructions for use supplied with the sampling line.
8. Perform the following checks:
  - a. Check that CO<sub>2</sub> values appear on the monitor.
  - b. Check the patient type. Make sure it is correct to ensure accurate sampling.
  - c. Touch the alarm control to ensure the alarms are set appropriately.

- d. Toggle to the waveform view to ensure that a complete waveform appears.



**NOTE** When the cannula is not on the patient, the etCO<sub>2</sub> value is blank.



**NOTE** After you connect the sampling line, the monitor immediately searches for breaths, but it does not indicate a No Breath condition before any valid breaths have been detected.



**NOTE** To avoid moisture buildup and sampling line occlusion during suction or nebulization of intubated patients, stop the CO<sub>2</sub> pump and remove the sampling line luer connector from the monitor.



**NOTE** Replace the sampling line according to hospital protocol or when a blockage is indicated by the device. Excessive patient secretions or a buildup of liquids in the airway tubing might occlude the sampling line, requiring more frequent replacement.



**NOTE** When the message "Check for occlusion in gas line" appears on the screen, indicating that the sampling line attached to the monitor is blocked, the monitor's CO<sub>2</sub> pump will stop. Follow the instructions in the Troubleshooting section of this manual to correct the problem.

## Stop and restart the CO<sub>2</sub> pump

Stopping the CO<sub>2</sub> pump prevents the ingress of fluids into the CO<sub>2</sub> module during certain patient procedures (such as suction or lavage). In addition, this pump-stop condition pauses the monitoring of all parameters obtained from the CO<sub>2</sub> module for a configured period of time or until you restart the CO<sub>2</sub> pump.

1. To temporarily pause or stop CO<sub>2</sub> monitoring, touch the pump-stop button  in the etCO<sub>2</sub> frame.



**NOTE** This button is a toggle. When you stop the CO<sub>2</sub> pump, the Start button with a countdown timer appears.

2. To resume CO<sub>2</sub> monitoring, touch the pump-start button .

The CO<sub>2</sub> pump restarts, the current timer clears, and the Stop button appears in the frame.

## Respiration rate

### RR frame

The RR frame displays the following:

- Respiration rate in breaths per minute (BPM)
- Alarm limit control



**NOTE** RR monitoring is available only in the Continuous Monitoring profile.

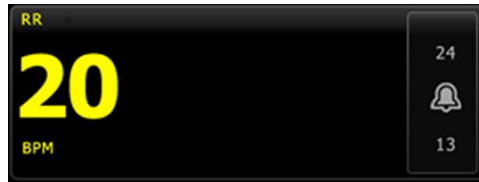

## Set up RR

Only alarm delays and modifiers can be changed for the **RR** parameter. See "Configure RR alarms" to adjust alarm settings. Follow these steps to set up RR modifiers, if applicable.

1. Touch the **Patients** tab.
2. Touch the **Manual** tab.
3. Scroll through the list to find the RR section, then enter or select the RR modifier(s) as desired.



**NOTE** If no modifiers are associated with this parameter, no RR section will appear.

4. Touch **OK**.

The Home tab appears. In the Continuous Monitoring profile, the modifiers are saved with the next set of measurements sent to the network.

## Configure RR alarms

Follow these steps to set alarm limits for RR measurements.

1. Verify that you are using the Continuous Monitoring profile.



**NOTE** If "Allow profile change" is enabled in Advanced settings, the device attempts to shift automatically to the Continuous Monitoring profile when you connect the sensor cable.

2. Touch the **Alarms** tab.
3. Touch the **RR** vertical tab.
4. Ensure that the RR alarm limit control is set to ON.



**NOTE** If any parameter's alarm limit control is set to OFF, you cannot adjust alarm limits on the Alarm tab, and no visual or audio signals will occur for that specific parameter.

5. Adjust the following settings as desired:
  - RR limits. Enter upper and lower alarm limits for RR using the up/down arrow keys or the keypad.
  - High alarm delay. Select the duration from the list box. This alarm delay specifies the minimum duration of a high alarm limit condition to activate an alarm signal. You can set the default in Advanced settings.
  - No breath detected alarm delay. Select the duration from the list box. This alarm delay specifies the minimum duration of a no-breath condition to activate an alarm signal. You can set the default in Advanced settings.
6. Touch the **Home** tab.

The new alarm settings take effect immediately.

## IPI

The Integrated Pulmonary Index (IPI) integrates four parameters and their interactions to provide a numeric value indicating a patient's overall respiratory status. The integrated parameters are etCO<sub>2</sub>, RR, SpO<sub>2</sub>, and PR. The additional status information provided by IPI enables you to intervene before values of individual parameters reach levels of clinical concern.



**NOTE** IPI is available for adult patients as well as three groups of pediatric patients (1–3 years, 3–6 years, and 6–12 years), but it is not available for neonatal/infant patients.



**NOTE** Pediatric patient subtypes appear on the Patient Summary tab and on the Home tab as a label in the IPI frame, but they do not appear in the Patient frame.



**NOTE** IPI is available only with the Continuous Monitoring profile.

The range of IPI is 1–10. These values can be interpreted as indicated in the following table.

Index range	Patient status
10	Normal
8–9	Within normal range
7	Close to normal range; requires attention
5–6	Requires attention and may require intervention
3–4	Requires intervention
1–2	Requires immediate intervention



**NOTE** The interpretation of a patient's IPI value might change in different clinical conditions. For example, patients who have a history of respiratory difficulties might require a lower IPI Low Alert threshold that takes into account their diminished respiratory capacity.

## IPI frame

The IPI frame displays a numeric value from 1–10 as well as an alarm threshold and control.

The frame provides a numeric view and a graphical trend view of IPI data. You can toggle between views by touching the left side of the frame.

### IPI numeric view

This view displays the numeric value for the integrated parameters.



The numeric view also includes a graphic indicator of the patient's current IPI value. As shown in the examples below, when the IPI value is 8, 9, or 10, the outline of the vertical bar is gray. When the IPI value is 4, 5, 6, or 7, the outline of the bar is yellow, and the middle section of the bar is shaded yellow. When the IPI value is 1, 2, or 3, the outline of the bar is red, and the lowest section of the bar is shaded red.

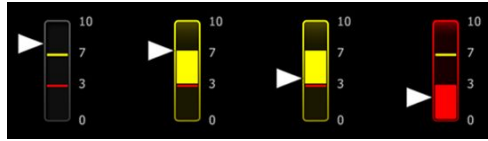

## IPI trend graph view

This view presents a graph of the IPI numeric values over a user-selected period and thus can alert you to changes in the patient's respiratory status. In Advanced settings, you can select the period displayed.

The size of the IPI frame and displayed trend data varies based on your configuration.



The graph shows the IPI value on the y-axis and time on the x-axis (oldest calculations on the left and newest calculations on the right). IPI values update once every second.

## Set up IPI

Follow these steps to configure IPI parameter options.

1. Touch the **Settings** tab.
2. Touch the **Setup** tab.
3. Touch the **IPI** vertical tab.
4. Adjust the Trend period as desired. You can set the default in Advanced settings.
5. Touch the **Home** tab.

The new settings take effect immediately.

6. Touch the patient type control on the right side of the Patient frame.

The Patient Summary tab appears.



**NOTE** IPI is available for adult patients as well as three groups of pediatric patients (1–3 years, 3–6 years, and 6–12 years), but it is not available for neonatal/infant patients.



**NOTE** If you are monitoring a pediatric patient, the following additional considerations apply when you select patient type:

Pediatric patients fall into one of three types based on their age: Ped 1–3, Ped 3–6, Ped 6–12. Because these age ranges overlap, consider details such as patient size and birth date to select Pediatric patient type.



**CAUTION** The characteristics of a breath are calculated differently for different patient types. Incorrect patient type selections cause inaccurate monitoring of the patient's respiration rate and affect the patient's IPI value.

7. Touch the Type list box and select patient type.



**NOTE** If you select Pediatric as a patient type, an information message prompts you to select a pediatric age range when you monitor IPI on pediatric patients, as shown here.

8. Touch **OK**.  
The Home tab appears.



**NOTE** Pediatric patient subtypes appear on the Patient Summary tab and on the Home tab as a label in the IPI frame, but they do not appear in the Patient frame.

## Configure IPI alarms

Follow these steps to set alarm limits for IPI.

1. Verify that you are using the Continuous Monitoring profile.



**NOTE** If "Allow profile change" is enabled in Advanced settings, the device attempts to shift automatically to the Continuous Monitoring profile when you connect the sensor cable.

2. Touch the **Alarms** tab.
3. Touch the **IPI** vertical tab.
4. Ensure that the Limits control is set to ON.



**NOTE** If any parameter's alarm limit control is set to OFF, you cannot adjust alarm limits on the Alarm tab, and no visual or audio signals will occur for that specific parameter.

5. Adjust the IPI limits setting as desired. Enter the desired lower alarm limit for IPI using the up/down arrow keys or the keypad.
6. Touch the **Home** tab.

The new alarm settings take effect immediately.

## Acoustic respiration rate (RRa)

Monitors configured with Masimo rainbow Acoustic Monitoring technology continuously and noninvasively measure respiration rate based on respiratory sounds produced in the upper airway. Respiratory sounds are detected through a sensor applied to the patient's neck.



**NOTE** RRa is available only in the Continuous Monitoring profile.



**NOTE** Masimo SpO2 monitoring is required when monitoring RRa.



**NOTE** RRa monitoring is only for adult patients who weigh more than 66 pounds (30 kilograms).



**NOTE** Monitors configured with RRa cannot be configured with CO2 or SpHb.

## RRa frame

The RRa frame displays the following:

- Respiration rate in breaths per minute (BPM)
- Respiration Indicator
- Alarm limit control
- Averaging control toggle providing the options of slow, medium, fast, trending, and off



**NOTE** RRa is available only when the Continuous Monitoring profile and Adult patient type are selected.



## Respiration Indicator

The Respiration Indicator displays the level of sound detected by the RRa sensor. A higher level of sound causes more bars to illuminate.



## Averaging selector

The averaging selector enables you to choose the desired visibility of subtle variations in RRa measurements. You can adjust averaging in the RRa frame by touching the averaging selector



Use this control toggle to select an averaging option (off, slow, medium, fast, or trending) while acquiring readings.

### Averaging selector options



Off



Fast

~10 seconds



Medium

~20 seconds



Slow

~30 seconds



Trending

~60 seconds

You can set the RRa averaging default in Advanced settings. Averaging is set to default settings when any of the following occurs:

- The device starts up
- You change or clear patient context

## Set up RRa

Default settings for the **RRa** parameter can be changed only in Advanced settings.

## Configure RRa alarms

Follow these steps to set alarm limits for RRa measurements.

1. Verify that you are using the Continuous Monitoring profile.



**NOTE** If "Allow profile change" is enabled in Advanced settings, the device attempts to shift automatically to the Continuous Monitoring profile when you connect the sensor cable.

2. Verify that the patient type is Adult.
3. Touch the **Alarms** tab.
4. Touch the **RRa** vertical tab.
5. Ensure that the RRa alarm limit control is set to ON.



**NOTE** If any parameter's alarm limit control is set to OFF, you cannot adjust alarm limits on the Alarm tab, and no visual or audio signals will occur for that specific parameter.

6. Adjust the following settings as desired:
  - RRa limits. Enter upper and lower alarm limits for RRa using the up/down arrow keys or the keypad.
  - Alarm delay. Select the duration from the list box. This alarm delay specifies the minimum duration of an alarm limit condition to activate an alarm signal. The alarm delay you select impacts both upper and lower alarm limits. You can set the default in Advanced settings.
  - No breath detected alarm delay. Select the duration from the list box. This alarm delay specifies the minimum duration of a no-breath condition to activate an alarm signal. You can set the default in Advanced settings.
7. Touch the **Home** tab.

The new alarm settings take effect immediately.



## Measure RRa

RRa monitoring is only for adult patients who weigh more than 66 pounds (30 kilograms).



**WARNING** Inaccurate measurement risk. Use only Masimo rainbow SET sensors and accessories on Masimo-equipped monitors.



**WARNING** The accuracy of RRa measurements can be affected by any of the following:

- Excessive ambient or environmental noise
- Improper sensor placement
- Failure to properly connect the sensor and cables



**WARNING** Masimo SpO2 monitoring is required when monitoring RRa.



**WARNING** Patient injury risk. Do not attempt to reprocess, recondition, or recycle any sensors or patient cables. Doing so might damage electrical components.



**WARNING** Patient injury risk. The sensor and extension cable are intended only for connection to pulse co-oximetry equipment. Do not attempt to connect these cables to a PC or any similar device. Always follow the sensor manufacturer's instructions for care and use of the sensor.

Before you begin, read the RRa sensor instructions for use.

1. Verify that the dual cable is connected to the monitor and to the SpO2 cable and the RRa cable. If a sensor is connected to the RRa cable, disconnect the sensor from the cable.



**NOTE** When the RRa sensor is off the patient and is connected to the monitor, the sensor might pick up periodic ambient sounds and report a measurement.

2. Verify that you are using the Continuous Monitoring profile.



**NOTE** If "Allow profile change" is enabled in Advanced settings, the device attempts to shift automatically to the Continuous Monitoring profile when you connect the sensor cable.

3. Verify that the patient type is Adult.
4. Verify that the alarms are set appropriately.
5. Start monitoring SpO2 as described in this instructions for use.
6. Attach the RRa sensor to the patient according to the manufacturer's instructions for use, observing all warnings and cautions.



**NOTE** The sensor is for single-patient use only. You can reuse the sensor on the same patient if it is clean and dry, and the adhesive still adheres to the skin. Otherwise, use a new sensor. Do not reuse the sensor on another patient.



**NOTE** Do not use disposable sensors on patients who have allergic reactions to the adhesive.



**NOTE** A process indicator  appears in the RRa frame until an RRa measurement is available for display.

7. Connect the RRA sensor to the RRA cable.
8. Confirm that the monitor displays RRA data within approximately 60 seconds of connection to the patient.



**WARNING** Patient injury risk. Incorrect sensor application or excessive duration of sensor use can cause tissue damage. Inspect the sensor site periodically as directed in the sensor manufacturer's instructions.

Detaching the sensor during a measurement triggers an alarm.

## NIBP

### Noninvasive Blood Pressure (NIBP) frame

From the NIBP frame, you can measure blood pressure.

The NIBP frame contains data and features relevant to noninvasive blood pressure measurement. The frame provides different features based on the profile you are using.

#### NIBP frame in Continuous Monitoring profile



The size of the NIBP frame and displayed measurements varies based on your configuration.

The Continuous Monitoring profile also provides a visual indication of aging episodic measurements (those more than 16 minutes old) and a timestamp indicating the time of the measurement. When a NIBP measurement is displayed for more than 16 minutes, the numerics on the screen change from their current color to gray. After one hour, these measurements are cleared from the frame.

#### NIBP frame in Intervals Monitoring profile



#### NIBP frame in Spot Check profile



## NIBP frame in Office profile





## NIBP measurement display

In all profiles, the frame can display systolic and diastolic measurements, and MAP calculations. You can configure the default view in Advanced settings.





## View indicator





Touch the NIBP frame to toggle between views.

- NIBP view 1  displays the SYS/DIA measurements as the primary content and the MAP calculation as secondary content.
- NIBP view 2  displays the MAP calculation as the primary content and the SYS/DIA as secondary content.

## Buttons

The buttons on the right side of the frame enable you to do different tasks depending on the profile you are using. The availability of functions depends on which profile is selected. See the Profiles section for more information.

Button name	Button image	Description
Start/Stop		<p>The appearance and function of this button dynamically changes.</p> <p><b>NOTE</b> A process indicator  appears in the NIBP frame until the NIBP parameter has initialized.</p>
		<p>Touch to start a manual measurement or a cycle of automatic measurements.</p>
		<p>Touch to stop a measurement that is in progress.</p> <p>In the Office profile,</p> <ul style="list-style-type: none"> <li>• Touch to stop a manual NIBP measurement.</li> <li>• Touch to stop the current measurement and stop an NIBP averaging program.</li> </ul>
Interval - Continuous Monitoring, Intervals Monitoring, and Spot Check profiles		
This button shows the status of automatic measurements.		

Button name	Button image	Description
		Touch the button to display the Intervals tab, where you can configure automatic measurements.
		Automatic measurements are off.
		Automatic measurements are on.
Interval - Office profile		
		Touch the button to display the Intervals tab, where you can start an NIBP averaging program.
		<ul style="list-style-type: none"> <li>• Touch to access the Intervals tab, where you can stop the NIBP averaging program.</li> <li>• Counts down to the next measurement in an NIBP averaging program.</li> </ul>
Alarm Limit control		This button displays alarm status. It also displays alarm limits in some device configurations.
		Touch the button to display the Alarms tab.

## Select a cuff



**WARNING** Use only blood pressure cuffs and hoses listed as approved accessories to ensure safe and accurate NIBP measurements.



**WARNING** Never use an adult or pediatric monitor setting or cuff for an NIBP measurement on a neonatal patient. Adult and pediatric inflation limits can be excessive for neonatal patients, even if a neonatal cuff is used. Neonates are defined in the AAMI SP10:2002 standard as children 28 days or less of age if born at term (37 weeks gestation or more); otherwise, up to 44 gestational weeks.



**CAUTION** Correct sizing of the blood pressure cuff is important for accurate blood pressure readings. A cuff that is too small might provide false high readings, while a cuff that is too large might provide false low readings.

The monitor uses the oscillometric method to determine blood pressure; therefore, if the cuff extends to the antecubital fossa (bend in the elbow), you can still acquire an accurate blood pressure reading.

Before taking an NIBP measurement, follow these steps to select the appropriate cuff for the patient.

1. Measure the circumference of the patient's bare upper arm, midway between the elbow and shoulder.
2. Choose the appropriate cuff size based on the circumference measurement. If the circumference of the patient's arm falls between two cuff sizes, use the larger cuff size.
3. Wrap the cuff around the patient's bare upper arm and verify that the artery index marker lies somewhere between the two range markings on the cuff.

## Cuff measurements

The following tables provide measurements for Welch Allyn blood pressure cuffs.

### One-piece cuff measurements

Cuff Size	Circumference (cm)	Circumference (in)
Infant	9.0 – 13.0	3.5 – 5.1
Small child	12.0 – 16.0	4.7 – 6.3
Child	15.0 – 21.0	5.9 – 8.3
Small adult	20.0 – 26.0	7.9 – 10.2
Adult	25.0 – 34.0	9.8 – 13.4
Large adult	32.0 – 43.0	12.6 – 16.9
Thigh	40.0 – 55.0	15.7 – 21.7

### Neonatal soft disposable cuffs with NeoQuik connectors

Cuff Size	Circumference (cm)	Circumference (in)
NEO 1	3.3 – 5.6	1.3 – 2.2
NEO 2	4.2 – 7.1	1.6 – 2.8
NEO 3	5.4 – 9.1	2.1 – 3.6
NEO 4	6.9 – 11.7	2.4 – 4.6
NEO 5	8.9 – 15.0	3.5 – 5.9
Multi-pack	1 of each	1 of each

For ordering information, see *Approved Accessories* in the Appendix.

## Position the cuff



**NOTE** The device and cuffs were validated using the bare upper arm site.



**WARNING** Patient injury risk. Inaccurate measurement risk. Do not place the cuff where it can disturb proper circulation. Do not place the cuff on any area where circulation is compromised or on any extremity used for intravenous infusions. Do not place the cuff on any limb where intravascular access or therapy, or an arterio-vascular (A-V) shunt is present. Observe the limb concerned to ensure that operation of the device does not result in prolonged impairment of circulation.



**WARNING** Patient injury risk. Inaccurate measurement risk. Do not use an SpO2 finger clip sensor and a blood pressure cuff simultaneously on the same limb. Doing so may cause a temporary loss of pulsatile flow, resulting in either no reading or an inaccurate SpO2 or pulse rate until the flow returns.



**WARNING** The blood pressure cuff must be properly positioned to ensure blood pressure accuracy and patient safety. Wrapping the cuff too loosely (preventing proper inflation) may result in inaccurate NIBP readings.



**CAUTION** If a site other than the bare upper arm is used, the blood pressure measurements may be different. It is important to document the alternate site on the patient record.

Before positioning the cuff, ensure that you have selected the appropriate cuff size.

The device uses the oscillometric method to determine blood pressure; therefore, if the cuff extends to the antecubital fossa (bend in the elbow), you can still acquire an accurate blood pressure reading.

1. Check the cuff for residual air from a previous measurement. Squeeze the cuff as needed to completely deflate the cuff.
2. Position the cuff on the patient's bare upper arm midway between the shoulder and the elbow.
3. Wrap the cuff snugly so that there is room for no more than two fingers between the cuff and the patient's bare upper arm.
4. Position the alignment mark on the cuff directly over the brachial artery.
5. Ensure that the blood pressure tubing has no kinks or twists.



**NOTE** In situations where you cannot position the cuff level with the heart, you should adjust the measurements as follows for greater accuracy. For each inch (2.54 cm) that the cuff is above the level of the heart, add 1.8 mmHg to the displayed reading. For each inch (2.54 cm) that the cuff is below the level of the heart, subtract 1.8 mmHg from the displayed reading. It is important to document the adjustment on the patient record.



**NOTE** For additional guidance addressing best practices for taking blood pressure measurements, see [Tips for Taking Accurate Blood Pressure Readings](#) on the Hillrom website.

## Set up NIBP

Follow these steps to configure NIBP parameter settings and to set up modifiers.

1. Touch the **Settings** tab.
2. Touch the **Setup** tab.
3. Touch the **NIBP** vertical tab.

4. Adjust the following setting as desired:
  - Cuff inflation target. If the monitor is set up for StepBP, enter the Cuff inflation target. You can set the default in Advanced settings.
5. Touch the **Home** tab.

The new setting takes effect immediately.
6. To set up modifiers, touch the **Patients** tab.
7. Touch the **Manual** tab.
8. Scroll through the list to find the NIBP section, then enter or select the NIBP modifier(s) as desired.
  - Cuff site. Select the site from the list box.
  - Cuff size. Select the size from the list box.
  - Patient position. Select the position from the list box.
9. Enter or select other modifier(s), if applicable, as desired.
10. Touch **OK**.

The Home tab appears. In the Continuous Monitoring profile, the modifiers are saved with the next set of measurements sent to the network. In the episodic profiles, the modifiers are saved with the next set of measurements you take or with any current, unsaved measurements on the device when you touch **Save**.

## Configure NIBP alarms

Follow these steps to set alarm limits for systolic and diastolic measurements, and MAP calculation.

1. Verify that you are using the Intervals Monitoring or Continuous Monitoring profile.
2. Touch the **Alarms** tab.
3. Touch the **NIBP** vertical tab.
4. Ensure that the NIBP and MAP alarm limit controls are set to ON.



**NOTE** If any parameter's alarm limit control is set to OFF, you cannot adjust alarm limits on the Alarm tab, and no visual or audio signals will occur for that specific parameter.

5. Adjust the following settings as desired:
  - Systolic. Enter upper and lower Systolic alarm limits using the up/down arrow keys or the keypad.
  - Diastolic. Enter upper and lower Diastolic alarm limits using the up/down arrow keys or the keypad.
  - MAP. Enter upper and lower MAP alarm limits using the up/down arrow keys or the keypad.
6. Touch the **Home** tab.

The new alarm settings take effect immediately.

## NIBP measurement

The monitor enables you to take manual and automatic NIBP measurements. In the Office profile, you can take manual measurements and use NIBP averaging programs (see "Office profile" near the end of the NIBP section).



**WARNING** Many environmental variables, including patient physiology and clinical application, can affect the accuracy and performance of the monitor. Therefore, you must verify all vital signs information, especially NIBP and SpO<sub>2</sub>, before treating the patient. If there is any question about the accuracy of a measurement, verify the measurement using another clinically accepted method.



**WARNING** Inaccurate measurement risk. Do not use the device or accessories in environments affected by extremes of temperature, humidity, or altitude. See "Environmental specifications" for acceptable operating conditions.



**WARNING** NIBP readings may be inaccurate for patients experiencing moderate to severe arrhythmia.



**WARNING** Do not allow a blood pressure cuff to remain on neonatal patients more than 90 seconds when inflated above 5 mmHg. Do not allow a blood pressure cuff to remain on the adult patients more than 3 minutes when inflated above 15 mmHg. Excessive cuff tightness may cause venous congestion, peripheral nerve injury, discoloration of the limb, and patient distress.



**WARNING** Inaccurate measurement risk. Pulse rate measurements generated through the blood pressure cuff or through SpO<sub>2</sub> are subject to artifact and might not be as accurate as heart rate measurements generated through ECG or through manual palpation.



**WARNING** Use caution when measuring blood pressure using oscillometric blood pressure devices in severely ill neonates and pre-term infants because these devices tend to measure high in this patient population.



**WARNING** Patient injury risk. Any external compression of the blood pressure hose or cuff or kinked tubing may cause patient injury, system errors, or inaccurate measurements.



**WARNING** Inaccurate measurement risk. Ensure an airtight seal at all connection points before use. Excessive leaking might affect readings.



**WARNING** Inaccurate measurement risk. Minimize cuff movement and arm motion during readings. Excessive movement might alter readings.



**WARNING** Inaccurate measurement risk. Only use the cuff when the artery index marker falls within the printed range indicated on the cuff; otherwise, erroneous readings will result.



**WARNING** Patient injury risk. Do not place the cuff on the arm on the same side of a mastectomy. If necessary, use the femoral artery in the thigh to take a measurement.



**WARNING** Patient injury risk. Do not apply the NIBP cuff over a wound.

At the start of a measurement, the monitor inflates the cuff to the appropriate level. In the NIBP frame, the systolic display shows the cuff inflation pressure while the blood pressure measurement is in progress.

The monitor measures blood pressure as the cuff is inflating. If patient movement, excessive noise, or an arrhythmia prevent the monitor from determining the blood pressure while the cuff is inflating, the monitor attempts to measure the blood pressure while deflating the cuff.

When the measurement is complete, the NIBP frame displays the measurement until you save it to the patient's record or you start another NIBP measurement.





**NOTE** The Pediatric and Adult blood pressure modes are supported on patients 29 days and older. The Pediatric mode gives you the option of setting a lower initial inflation pressure when using the StepBP deflation and not SureBP.



**NOTE** Use dual-lumen tubes for adult and pediatric blood pressure measurements and single-lumen tubes for neonate blood pressure measurements. Mismatching tube types, patient types, and algorithms causes an information message to appear in the Device Status area. For neonate patients, set the NIBP settings as follows: Patient = Neonate, Tube type = 1 tube, Algorithm = Step.



**NOTE** Welch Allyn uses the following definition of Neonate: Children 28 days or less of age if born at term (37 gestation or more); otherwise, up to 44 gestational weeks.

## Take a manual NIBP measurement



**WARNING** Patient injury risk. Never install Luer Lock connectors on Welch Allyn blood pressure cuff tubing. Using these connectors on blood pressure cuff tubing creates the risk of mistakenly connecting this tubing to a patient's intravenous line and introducing air into the patient's circulatory system.



**WARNING** Patient injury risk. Any external compression of the blood pressure hose or cuff or kinked tubing may cause patient injury, system errors, or inaccurate measurements.

1. Properly size the blood pressure cuff and position it around the patient's bare upper arm.



2. Touch  to take a measurement.

## Cancel a measurement that is in progress

Follow these steps to cancel any NIBP measurement that is in progress.



On the Home tab, touch

The monitor rapidly deflates the cuff, and the screen displays the NIBP cancellation message.

## Interval NIBP measurement

The monitor can take NIBP measurements automatically based on intervals you choose.

The Intervals tab provides all interval features.

From this tab, you can do the following:

- Configure intervals
- Turn off intervals
- Configure the monitor to print automatic measurements as they are completed

When the measurement is complete, the NIBP frame displays the measurement until the next measurement starts.



**NOTE** If single sign-on (SSO), "Require Clinician ID to save readings," or "Require Clinician ID match to save measurements" has been enabled in Advanced settings, Clinician login is required before you can save measurements.



**NOTE** In the Intervals Monitoring profile, each time automatic interval measurements are saved, manual parameter and predictive temperature measurements are cleared from the screen. When you manually save any patient measurements in this profile, all patient measurements are cleared from the screen.



**NOTE** In the Continuous Monitoring profile, all patient measurements remain onscreen when automatic interval measurements are saved.



The  button changes to a timer (  ), which counts down to the next automatic measurement.

Automatic measurements continue until you turn off intervals.



**WARNING** Patient harm risk. Do not use intervals on neonates out of earshot. Verify that audio can be heard from where you intend to be.

## Set up NIBP intervals

Follow these steps to configure NIBP intervals.

1. Touch the **Settings** tab.
2. Touch the **Setup** tab.
3. Touch the **Intervals** vertical tab.
4. Select **Automatic**, **Program**, or **Stat**, and follow the steps presented in the associated topics that follow.
5. To automatically print patient data at each interval, touch the **Automatic print on interval** checkbox.
6. To start intervals immediately, touch **Start intervals**. Otherwise, touch the **Home** tab.

The new settings take effect immediately.

## Automatic intervals

You can configure the monitor to take automatic NIBP measurements at consistent intervals. Use the spin box or keypad to set the desired interval.

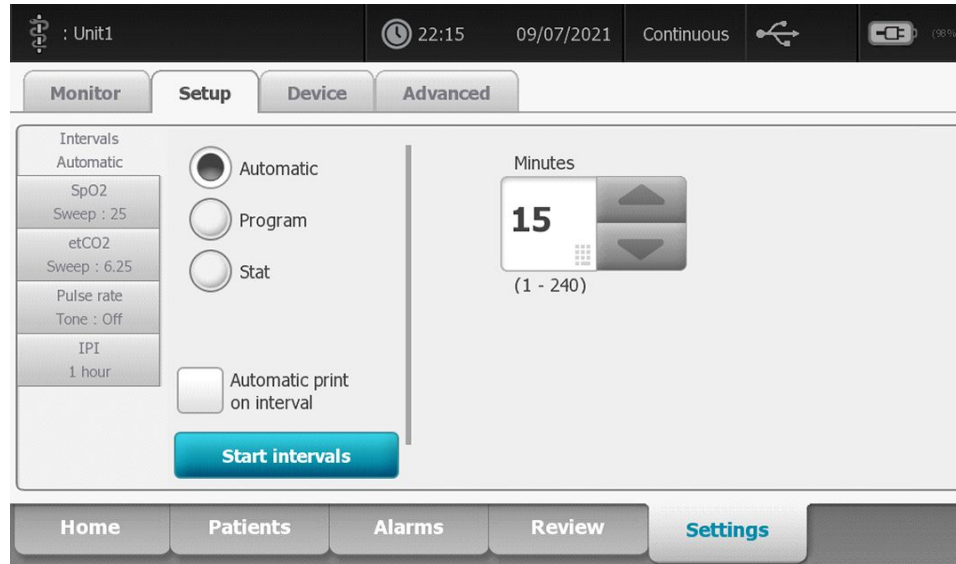

**NOTE** An alarm does not turn off intervals. Subsequent automatic measurements continue to occur as scheduled.

## Start automatic intervals

Follow these steps to configure the monitor to take NIBP measurements at consistent intervals.

1. Properly size the blood pressure cuff and position it around the patient's bare upper arm.



2. On the Home tab, touch .
3. Select **Automatic**.
4. Use the numeric keypad to enter the length of time between NIBP measurements.
5. Touch **Start intervals**.



**NOTE** Intervals are not available in all profiles. See the Profiles section for more information.

## Program intervals

You can configure the monitor to take automatic NIBP measurements at variable intervals. The monitor comes with preset interval programs that can be edited to meet your needs. You can rename selected programs using the keyboard feature. The columns below the selected program name indicate the length of each interval in the cycle (Interval) and the number of intervals you set (Frequency).

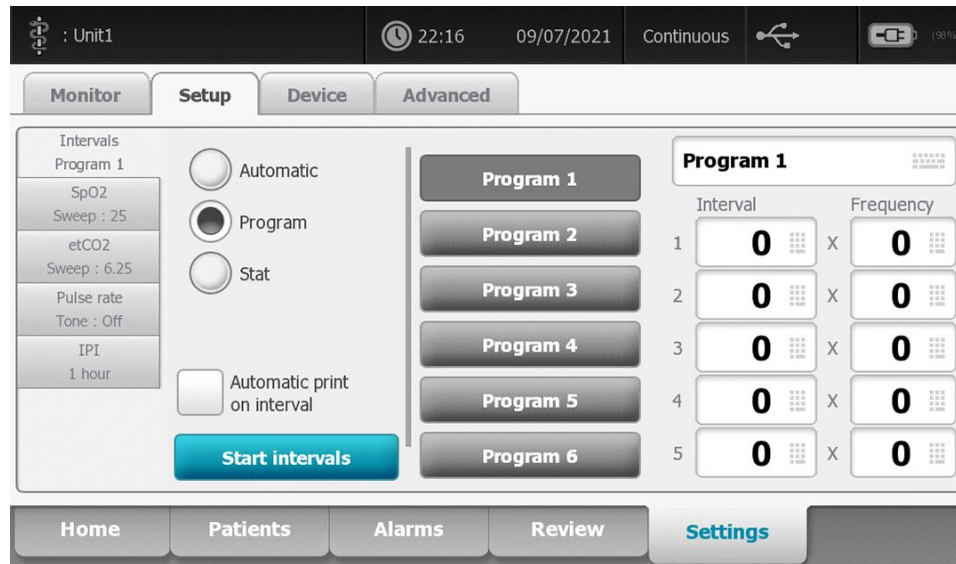

## Start program intervals

Follow these steps to configure the monitor to take automatic NIBP measurements at variable intervals.

1. Properly size the blood pressure cuff and position it around the patient's bare upper arm.





2. On the Home tab, touch .
3. Select **Program**.
4. Touch the desired program.
5. Touch **Start intervals**.

## Create a new program interval or edit an existing program

Follow these steps to create or edit a program interval.



1. On the Home tab, touch the interval button ( or )
2. Select **Program**.
3. Touch the desired program.
4. Touch the keyboard icon and enter the desired program name.
5. Enter the desired interval and frequency settings.
6. Touch **Start Intervals**.

The new intervals take effect at the start of the next NIBP measurement.

## Stat intervals

You can configure the monitor to take NIBP measurements continuously.

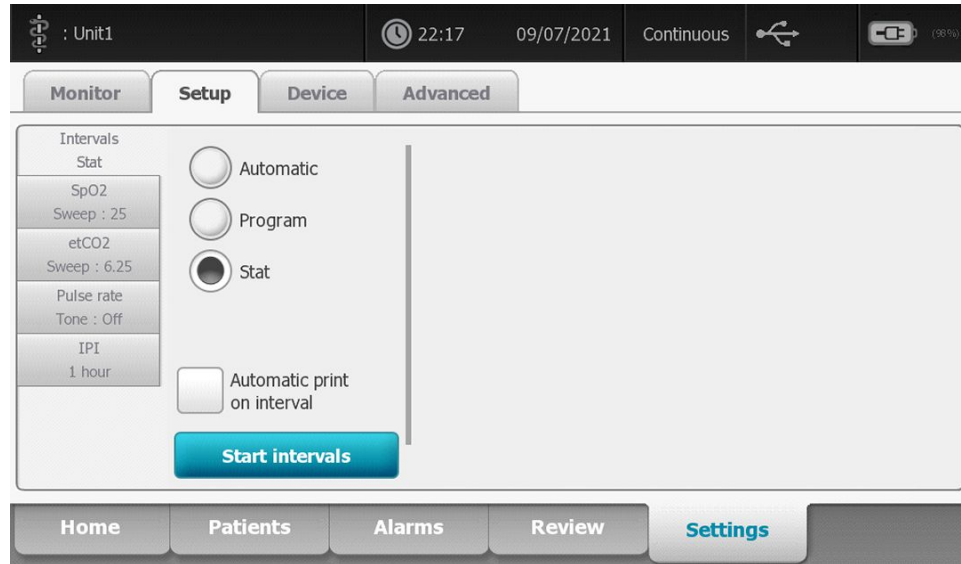

When you select the Stat option, the monitor takes repeated NIBP measurements for 5 minutes, starting a new cycle each time the cuff deflates below safe venous return pressure (SVRP) for 2 seconds.



**WARNING** Patient injury risk. If you use Stat mode repeatedly, periodically observe the patient's limb to ensure that circulation is not impaired and that the cuff remains in place. Prolonged impairment of circulation or improper cuff position can cause bruising.

Current cuff pressures are not dynamically displayed during a Stat reading. The Home tab displays the NIBP reading from the previous cycle until the current cycle finishes.



**NOTE** If you are in Stat intervals, you can stop intervals by touching

## Start Stat intervals

Follow these steps to start Stat intervals.

1. Properly size the blood pressure cuff and position it around the patient's bare upper arm.



2. On the Home tab, touch

3. Select **Stat**.

4. Touch **Start intervals**.

The Home tab appears with the intervals timer counting down from 0:05:00.

## Stop intervals measurements

Follow these steps to turn off intervals.



1. On the Home tab, touch the interval timer button (



**NOTE** The actual time remaining varies based on the length of the selected interval and the time expired.

## 2. Touch **Stop intervals.**



**NOTE** If you are in Stat intervals, you can also stop intervals on the Home tab by



touching

## Office profile

The Office profile enables you to take manual NIBP measurements and use NIBP averaging programs. You need to set up NIBP averaging programs in Advanced settings (see "Set up an NIBP averaging program").

## NIBP averaging programs

An NIBP averaging program displays the average of multiple NIBP readings.

To calculate the average, the program takes a set of readings. The example below shows a program in progress:

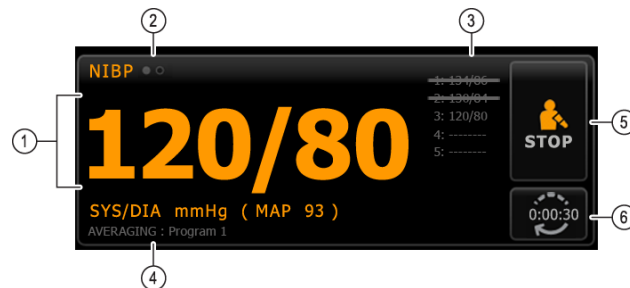

Number	Feature	Description
1	Numeric	Displays the most recent reading.
2	View indicator	Touch to toggle between NIBP views.
3	History	<ul style="list-style-type: none"> <li>Displays completed readings and placeholders for upcoming readings.</li> <li>A reading with a line through it is excluded from the average.</li> </ul>
4	Program	Displays the name of the program.
5	Stop	Touch to stop the current reading and terminate the program.
6	Interval	Counts down to the next reading.

After the program takes all readings, it displays the average reading, as follows:

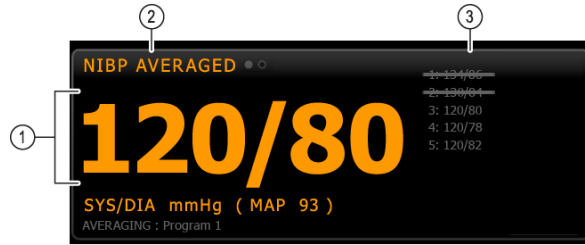

Number	Feature	Description
1	Numeric	Displays the average of the readings.
2	View indicator	Displays "NIBP AVERAGED."
3	History	<ul style="list-style-type: none"> <li>Displays the readings taken by the program.</li> <li>A reading with a line through it is excluded from the average.</li> </ul>

### Start an NIBP averaging program

To acquire an NIBP average, start an NIBP averaging program from the Setup tab and the vertical Intervals Program tab.

1. Properly size the blood pressure cuff and position it around the patient's bare upper arm.



2. On the Home tab, touch .

The Intervals Program tab appears.

3. Touch the desired program.

The specifications of the program appear in the Summary area.

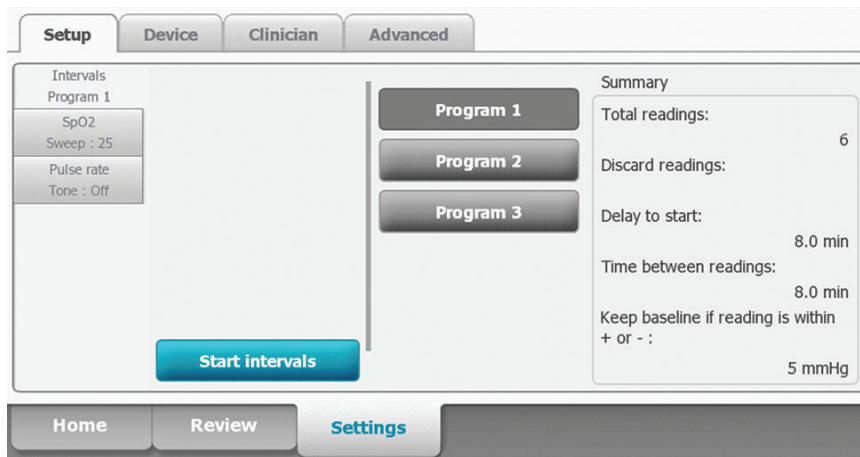

4. Read the Summary information to confirm that the specifications are appropriate for your patient:

Setting	Action/Description
Total readings	Number of readings that the program takes.

Discard readings	Readings that the program excludes from the average. For example, "1, 2" indicates that the program excludes the first and second readings.
Delay to start	Period between the start of the program (the moment that the "Start intervals" button is selected) and the start of the first reading.
Time between readings	Period between the end of one reading and the start of the next reading.
Keep baseline if reading is within + or -	Range that the program uses to establish the baseline reading. For more information about how this setting affects the program, refer to the section "Excluded readings" below.

5. Touch **Start intervals** to start the program.

The Home tab appears.

In the NIBP frame, the timer counts down the "Delay to start" period. The first NIBP reading begins when the timer reaches 0.

After the first reading is acquired, the timer counts down the "Time between readings" period. The next NIBP reading begins when the timer reaches 0.

After taking all readings, the program displays the average.



**NOTE** If a technical alarm condition occurs while a reading is in progress, the reading stops. The timer counts down the "Time between readings" period. When the timer reaches 0, the program attempts to take the reading again.



**NOTE** During an NIBP averaging program, the monitor saves all NIBP readings except the average. To retain an NIBP average, touch **Save** upon completion of the averaging program.

### Stop an NIBP averaging program



To stop an NIBP averaging program in progress, touch  on the Home tab.

The current reading stops, and the program terminates.



**NOTE** When a program has been stopped, it cannot be restarted at the point that it was stopped. To start a new NIBP averaging program, select a program in the Intervals tab and touch **Start intervals**.

### Excluded readings

An NIBP averaging program excludes readings for the following reasons:

- The reading is listed in the "Discard readings" setting of the program.
- The reading precedes the baseline reading.

The program establishes the baseline reading as follows:



- At the start of the program, Reading 1 is the baseline reading.
- The program compares the systolic value of Reading 2 to the systolic value of Reading 1.
- If the difference between the values is within the "Keep baseline" range, Reading 1 remains the baseline. The program compares the next reading to Reading 1, and so on.
- If a reading is outside the range, that reading becomes the new baseline, and the program excludes from the average all readings that preceded the new baseline.
- After establishing a new baseline, the program compares subsequent readings to the new baseline and applies the rules described above.

## BMI frame

The BMI frame displays body mass index (BMI), weight, and height.



**NOTE** This frame is available only in the Office profile.



Weight and height measurements can be entered manually or transferred from an attached weight scale. The profile calculates BMI based on weight and height input.



**NOTE** When a weight or height measurement is transferred from an attached weight scale to the monitor, the measurement displayed on the monitor is within one decimal place (0.1) of the measurement displayed by the weight scale.

## Enter weight and height

The BMI frame enables you to enter weight and height measurements taken manually, and it displays weight and height measurements taken by an attached weight scale.



**CAUTION** Weight scales attached to this monitor must be running on battery power (battery type is specified in the weight scale manufacturer's directions for use). Do not use the weight scale's external power supply.

1. Verify that you are using the Office profile.
2. From the Home tab, touch the up/down arrow keys or the keypad to manually adjust weight and height.



**NOTE** If an approved, battery-powered weight scale is attached to the monitor, weight and height measurements from the weight scale populate fields in the BMI frame.

The BMI value changes based on weight and height input.

## Pain frame

In the Pain frame, you can manually enter the patient's pain level.



**NOTE** This frame is available only in the Office profile.



### Enter pain level

1. Verify that you are using the Office profile.
2. From the Home tab, touch the up/down arrow keys or the keypad to manually adjust the pain level.

## Temperature

### Temperature frame

From the temperature frame you can measure patient temperature.

The temperature frame contains data and features relevant to temperature measurement. The frame provides different features based on the profile you are using.

### Temperature frame in Continuous Monitoring profile

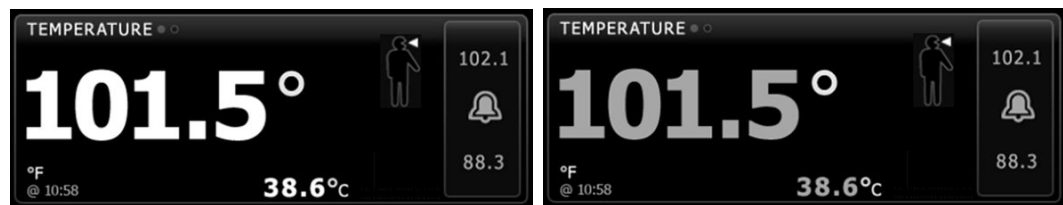

The size of the Temperature frame and displayed measurements varies based on your configuration.

The Continuous Monitoring profile also provides a visual indication of aging episodic measurements (those more than 16 minutes old) and a timestamp indicating the time of the measurement. When a temperature measurement is displayed for more than 16 minutes, the numerics on the screen change from their current color to gray. After one hour, these measurements are cleared from the frame.

### Temperature frame in Intervals Monitoring profile



### Temperature frame in Spot Check profile



### Temperature frame in Office profile

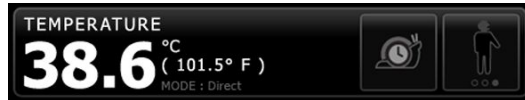

### Temperature measurement display

In all profiles, the frame can display temperature in Celsius or Fahrenheit. You can configure the default view in Advanced settings.

### Site selection



**NOTE** When taking temperature readings with either the SureTemp or Braun thermometer, the reference site is the measurement site. Therefore, no temperature readings require adjustments.



**NOTE** For additional guidance addressing core temperature and variations in body temperature by measurement site, see the "[Normal Body Temperature Ranges](#)" Quick Reference Card on the Hillrom website.

Remove the temperature probe and touch the **Temperature site control**  to toggle between sites.

#### Pediatric axillary



#### Adult axillary



#### Oral



**NOTE** Monitors configured with the temperature module and the red rectal probe well and probe default to the rectal mode.

#### Rectal



**NOTE** The monitor displays the tympanic mode when it receives a temperature measurement from the ear thermometer.

#### Ear



## Temperature buttons

The buttons on the right side of the frame enable you to do different tasks depending on the profile you are using. The availability of functions depends on which profile is selected.

Button name	Button image	Description
Temperature alarm		<p>This button displays alarm status. It also displays alarm limits in some device configurations.</p> <p>Touch the button to display the Alarms tab.</p>
Direct mode		<p>Touch the button to enter Direct mode.</p>

## Configure temperature alarms

Follow these steps to set alarm limits for temperature measurement.

1. Verify that you are using the Intervals or Continuous profile.
2. Touch the **Alarms** tab.
3. Touch the **Temperature** vertical tab.
4. Ensure that the Temperature alarm limit control is set to ON.



**NOTE** If any parameter's alarm limit control is set to OFF, you cannot adjust alarm limits on the Alarm tab, and no visual or audio signals will occur for that specific parameter.

5. Adjust the Temperature limits as desired. Enter the desired upper and lower alarm limits for temperature using the up/down arrow keys or the keypad.
6. Touch the **Home** tab.

The new alarm settings take effect immediately.

## SureTemp<sup>®</sup> Plus temperature module

The temperature module uses a thermistor thermometer design and a predictive algorithm to calculate patient temperatures in the Predictive mode.



**WARNING** Patient injury risk. Do not exceed the recommended temperature measurement durations in Direct mode. Continuous measurement durations of 3 minutes at the oral and rectal sites and 5 minutes at the axillary site are recommended for accurate measurement. Do not continuously measure beyond 10 minutes in any mode.



**WARNING** Patient injury risk. Inaccurate measurement risk. Oral/axillary probes (blue ejection button at top of probe) and blue removable probe wells are used for taking oral and axillary temperatures only. Rectal probes (red ejection button) and red removable probe wells are used for taking rectal temperatures only. Use of the incorrect removable probe well could result in patient cross-contamination. Use of the probe at the wrong site will result in temperature errors.



**WARNING** Patient injury risk. When taking rectal temperatures, insert the probe tip a maximum of 5/8 inch (approximately 1.5 cm) inside the rectum of adults and a maximum of 3/8 inch (approximately 1 cm) inside the rectum of children to avoid the risk of bowel perforation.



**WARNING** Inaccurate measurement risk. Always take an axillary temperature with direct contact between the probe cover and the skin. Carefully place the probe in the axilla, avoiding contact with other objects or material.



**WARNING** Patient injury risk. Always take a temperature measurement with a Welch Allyn single-use probe cover securely attached. Failure to use a probe cover can cause patient discomfort from a heated probe, patient cross-contamination, and inaccurate temperature readings.



**WARNING** Inaccurate measurement risk. To ensure optimal accuracy, always confirm that the correct mode and site are selected.



**WARNING** Never use a damaged temperature probe. The thermometer consists of high-quality precision parts and should be protected from severe impact or shock. Do not use the thermometer if you notice any signs of damage to the probe or monitor. If the thermometer probe is dropped or damaged, remove it from use and have it inspected by qualified service personnel.



**WARNING** Inaccurate measurement risk. Apply a thin layer of lubricant to probe cover, if necessary, for patient comfort. Use of excessive lubricant may affect reading accuracy.



**WARNING** Many environmental variables, including patient physiology and clinical application, can affect the accuracy and performance of the monitor. Therefore, you must verify all vital signs information, especially Temperature, before treating the patient. If there is any question about the accuracy of a measurement, verify the measurement using another clinically accepted method. If the thermometer configured with the device is unavailable for any reason, use a different thermometer.



**WARNING** Patient injury risk. Always remain with patient while measuring temperature.



**CAUTION** Inaccurate measurement risk. Patient activities such as strenuous exercise, ingesting hot or cold liquids, eating, chewing gum or mints, brushing teeth, or smoking may affect oral temperature measurements for up to 20 minutes.



**CAUTION** Inaccurate measurement risk. Always use new probe covers taken from the monitor's probe cover box holder to ensure accurate temperature measurements. Probe covers taken from other places or that haven't stabilized in temperature may result in inaccurate temperature measurements.



**CAUTION** Probe covers are disposable, nonsterilized, and single-use. Probes are also nonsterilized. Do not autoclave probes and probe covers. Ensure that probe covers are disposed of according to facility requirements or local regulations.



**CAUTION** Do not use the Suretemp to take or monitor the patient's temperature during defibrillation or electrosurgery. This may damage the temperature probe.

## Temperature mode selection

The monitor with the temperature module takes a patient temperature in either Predictive (Normal) or Direct mode. The default setting is the Predictive mode.



**WARNING** Inaccurate measurement risk. To ensure optimal accuracy, always confirm that the correct mode and site are selected.



**WARNING** Patient injury risk. Do not exceed the recommended temperature measurement durations in Direct mode. Continuous measurement durations of 3 minutes at the oral and rectal sites and 5 minutes at the axillary site are recommended for accurate measurement. Do not continuously measure beyond 10 minutes in any mode.

### Predictive mode

Is a one-time measurement that takes a temperature in approximately 6 to 15 seconds. Removing the probe from the probe well, loading a probe cover, and holding the probe tip in place at the measurement site initiates a Predictive mode measurement. The monitor sounds a tone to indicate the end of a predictive measurement.

### Direct mode

Provides continual temperature measurements. For oral and rectal measurements, it is recommended to measure temperature until the temperature stabilizes or for 3 minutes. For axillary measurements, it is recommended to measure temperature until the temperature stabilizes or for 5 minutes. The monitor changes to Direct mode approximately 60 seconds after the probe is removed from the probe well.



**NOTE** The monitor does not retain Direct mode temperatures in memory. Therefore, it is important to note the temperature before removing the probe from the measurement site and then manually record it in the patient record.

After 10 minutes of using the Direct mode, the monitor generates a technical alarm condition and clears the measurement.

## Take a temperature in the Predictive mode



**WARNING** Inaccurate measurement risk. To ensure optimal accuracy, always confirm that the correct mode and site are selected.



**WARNING** Patient injury risk. Prior to taking a temperature, instruct the patient not to bite down on the probe as patient injury and damage to the probe may result.



**CAUTION** Probe covers are disposable, nonsterilized, and single-use. Probes are also nonsterilized. Do not autoclave probes and probe covers. Ensure that probe covers are disposed of according to facility requirements or local regulations.

1. Remove the temperature probe from the probe well.  
The monitor sounds a tone as it enters the ready state.
2. Insert the probe into a new probe cover and press the probe handle down firmly.
3. Touch the **Temperature site control**  to choose from these measurement sites: oral, pediatric axillary, or adult axillary.
4. Hold the probe tip in place at the measurement site.

For oral temperatures, place the probe tip under the patient's tongue on either side of the mouth to reach the sublingual pocket and ask the patient to close his/her lips.



**NOTE** Do not hand the probe to patients to place in their mouth.

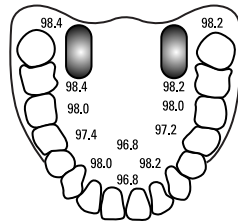

For axillary temperatures, lift the patient's arm so that the entire axilla is easily seen and place the probe tip as high as possible in the mid-axilla. Verify that axillary tissue completely surrounds the probe tip and place the arm snugly at the patient's side.

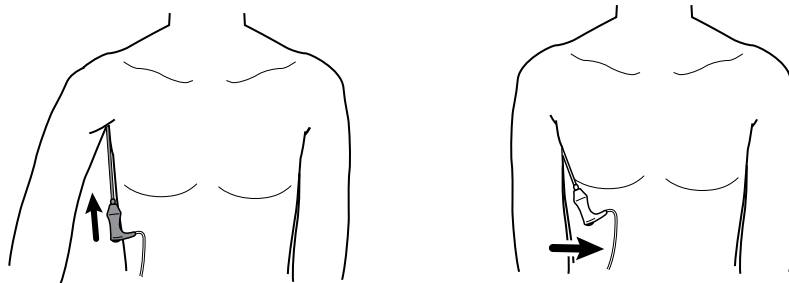

While the measurement is taking place, the temperature frame displays the process indicator.



5. The monitor sounds a tone when the final temperature is reached (in approximately 6 to 15 seconds). The temperature frame continues to display the temperature even after the probe is returned to the probe well.



**NOTE** To switch to the Direct mode, touch  after you

acquire the Predictive mode measurement. The temperature frame displays text indicating that the Direct mode is active.

The monitor sounds a tone at the start of a Direct mode measurement.

6. Remove the probe after the temperature measurement is complete and firmly press the eject button on the top of the probe to release the probe cover.



**WARNING** Patient injury risk. Do not exceed the recommended temperature measurement durations in Direct mode. Continuous measurement durations of 3 minutes at the oral and rectal sites and 5 minutes at the axillary site are recommended for accurate measurement. Do not continuously measure beyond 10 minutes in any mode.

Ensure that probe covers are disposed of according to facility requirements or local regulations.

7. Return the probe to the probe well.
8. Wash your hands to reduce the risk of cross-contamination.

## Take a temperature in the Direct mode

Direct mode displays the temperature of the probe as long as the probe tip remains in place at the measurement site and remains within the operating patient temperature range. The patient's temperature will reach final equilibrium in approximately 3 minutes at the oral and rectal measurement sites and approximately 5 minutes at the axillary site.

The monitor enters Direct mode by the following methods.

- After you complete a Predictive mode measurement, touch  to switch from Predictive to Direct mode. The temperature frame displays text indicating that the Direct mode is active.
- Remove the probe from the probe well, load a probe cover, select a temperature site, and expose the probe to ambient air for more than 60 seconds to switch the monitor to Direct mode. The temperature frame displays text indicating that the Direct mode is active.
- If you have a patient whose body temperature is below the normal temperature range and you follow the previous step, the probe sensor identifies this condition and turns off the probe preheater in order to accommodate the lower body temperature measurement.



**WARNING** Patient injury risk. Do not exceed the recommended temperature measurement durations in Direct mode. Continuous measurement durations of 3 minutes at the oral and rectal sites and 5 minutes at the axillary site are recommended for accurate measurement. Do not continuously measure beyond 10 minutes in any mode.



**WARNING** Inaccurate measurement risk. To ensure optimal accuracy, always confirm that the correct mode and site are selected.





**WARNING** Patient injury risk. Prior to taking a temperature, instruct the patient not to bite down on the probe as patient injury and damage to the probe may result.



**CAUTION** Probe covers are disposable, nonsterilized, and single-use. Probes are also nonsterilized. Do not autoclave probes and probe covers. Ensure that probe covers are disposed of according to facility requirements or local regulations.

1. Remove the temperature probe from the probe well.  
The monitor sounds a tone as it enters the ready state.
2. Insert the probe into a new probe cover and press the probe handle down firmly.
3. Touch the **Temperature site control**  to choose from these measurement sites: oral, pediatric axillary, or adult axillary.  
The temperature frame changes to Direct mode approximately 60 seconds after the probe is removed from the probe well.  
The monitor sounds a tone to indicate the start of a Direct mode measurement.
4. Hold the probe tip in place at the oral or rectal measurement site for a total of 3 minutes and for 5 minutes at the axillary site.
5. While the measurements are taking place, the temperature frame displays the patient's continuous temperature measurements.



**NOTE** The monitor does not retain Direct mode temperatures in memory. Therefore, it is important to note the temperature before removing the probe from the measurement site and then manually record it in the patient record.

6. Remove the probe after the temperature measurement is complete and firmly press the eject button on the top of the probe to release the probe cover.
7. Return the probe to the probe well to continue taking temperatures in the Predictive mode.
8. Wash your hands to reduce the risk of cross-contamination.

## Take a temperature at the rectal site



**WARNING** Patient injury risk. When taking rectal temperatures, insert the probe tip only 5/8 inch (approximately 1.5 cm) inside the rectum of adults and only 3/8 inch (approximately 1 cm) inside the rectum of children to avoid the risk of bowel perforation.



**WARNING** Cross-contamination or nosocomial infection risk. Thorough hand-washing greatly reduces the risk of cross-contamination and nosocomial infection.



**WARNING** Patient injury risk. Do not exceed the recommended temperature measurement durations in Direct mode. Continuous measurement durations of 3 minutes at the oral and rectal sites and 5 minutes at the axillary site are recommended for accurate measurement. Do not continuously measure beyond 10 minutes in any mode.



**WARNING** Inaccurate measurement risk. To ensure optimal accuracy, always confirm that the correct mode and site are selected.



**CAUTION** Probe covers are disposable, nonsterilized, and single-use. Probes are also nonsterilized. Do not autoclave probes and probe covers. Ensure that probe covers are disposed of according to facility requirements or local regulations.

1. Remove the rectal temperature probe from the rectal probe well.

The monitor sounds a tone as it enters the ready state. The Temperature Site Control defaults to the rectal site.



2. Insert the rectal probe into a new probe cover and press the probe handle down firmly.
3. Separate the patient's buttocks with one hand. Use the other hand to gently insert the probe tip only 5/8 inch (1.5 cm) inside the rectum of adults and only 3/8 inch (approximately 1 cm) inside the rectum of children. The use of a lubricant is optional.
4. Insert the probe so that the tip is in contact with tissue. Continue to separate the buttocks and hold the probe in place throughout the measurement process. While the measurement is taking place, the temperature frame displays the process indicator.



5. The monitor sounds a tone when the final temperature is reached (in approximately 10 to 13 seconds). The temperature frame continues to display the temperature even after the probe is returned to the probe well.



**NOTE** To switch to the Direct mode, touch  after the

Predictive mode measurement is acquired. The temperature frame displays text indicating that the Direct mode is active. The monitor sounds a tone to indicate the start of a Direct measurement. Once you are in the Direct mode, continue to separate the buttocks and hold the probe in place throughout the measurement process.



**NOTE** The monitor does not retain Direct mode temperatures in memory. Therefore, it is important to note the temperature before removing the probe from the measurement site and then manually record it in the patient record.

6. Remove the probe after the temperature measurement is complete and firmly press the eject button on the top of the probe to release the probe cover.
7. Return the probe to the probe well.
8. Wash your hands to reduce the risk of cross-contamination.

## Braun ThermoScanPRO thermometer and accessory dock

The thermometer and accessory dock enable you to transfer an ear temperature measurement to the monitor. The dock also charges the thermometer battery.

Read the thermometer manufacturer's instructions for use before attempting to configure, use, troubleshoot, or maintain the thermometer.



**WARNING** Liquids can damage electronics inside the thermometer. Prevent liquids from spilling on the thermometer. If liquids are spilled on the thermometer, dry off the thermometer with a clean cloth. Check for proper operation and accuracy. If liquids possibly entered the thermometer, remove the thermometer from use until it has been properly dried, inspected, and tested by qualified service personnel.



**WARNING** Many environmental variables, including patient physiology and clinical application, can affect the accuracy and performance of the monitor. Therefore, you must verify all vital signs information, especially Temperature, before treating the patient. If there is any question about the accuracy of a measurement, verify the measurement using another clinically accepted method. If the thermometer configured with the device is unavailable for any reason, use a different thermometer.



**CAUTION** Probe covers are disposable, nonsterilized, and single-use. The thermometer is also nonsterilized. Do not autoclave the thermometer and probe covers. Ensure that probe covers are disposed of according to facility requirements or local regulations.



**CAUTION** The thermometer has no user-serviceable parts. If service is required, call your nearest Welch Allyn Customer Service or Technical Support facility.



**CAUTION** Store the thermometer and probe covers in a dry location, free from dust and contamination and away from direct sunlight. Keep the ambient temperature at the storage location fairly constant and within the range of 50 °F to 104 °F (10 °C to 40 °C).

## Take a temperature at the ear site



**WARNING** Probe covers are single-use only. Re-use of a probe cover may result in spread of bacteria and cross-contamination.



**WARNING** Inaccurate measurement risk. Use only Braun ThermoScan probe covers with this thermometer.



**WARNING** Inaccurate measurement risk. Frequently inspect the probe window and keep it clean, dry, and undamaged. Fingerprints, cerumen, dust, and other contaminants reduce the transparency of the window and result in lower temperature measurements. To protect the window, always keep the thermometer in the accessory dock when the thermometer is not in use.



**CAUTION** Inaccurate measurement risk. Before taking a temperature measurement, make sure that the ear is free from obstructions and excess cerumen build-up.



**CAUTION** Inaccurate measurement risk. The following factors can affect ear temperature measurements for up to 20 minutes:

- The patient was lying on his or her ear.
- The patient's ear was covered.
- The patient was exposed to very hot or very cold temperatures.
- The patient was swimming or bathing.
- The patient was wearing a hearing aid or an ear plug.



**CAUTION** Inaccurate measurement risk. If ear drops or other ear medications have been placed in one ear canal, take the temperature in the untreated ear.



**NOTE** A temperature measurement taken in the right ear might differ from a measurement taken in the left ear. Therefore, always take the temperature in the same ear.



**NOTE** When the monitor receives an ear temperature measurement, it displays the measurement on the Home tab. If the Home tab already contains a temperature measurement, the new measurement overwrites it.

To take a measurement and transfer it to the monitor:

1. Make sure that the monitor is powered on.
2. Remove the ear thermometer from the accessory dock.

The thermometer turns on automatically when you remove the thermometer from the dock.



**NOTE** If the thermometer has been undocked, it turns on after you complete step 4.

3. Locate the probe cover box in the accessory dock.
4. Firmly push the probe tip into the probe cover box.

When the probe cover is in place, previously undocked thermometers turn on automatically.

5. Proceed as follows based on your Braun thermometer model:
  - Braun 4000: Wait for the ready beep and three dashes to appear on the thermometer display.
  - Braun 6000: Wait for the ready beep, three dashes to appear on the thermometer display, and the ring around the Measure button to turn green.
6. Fit the probe snugly into the ear canal and proceed as follows based on your Braun thermometer model:
  - Braun 4000: Push and release the **Start** button.
  - Braun 6000: Push and release the **Measure** button.
  - If the probe is positioned correctly in the ear canal the ExacTemp light flashes. When the thermometer detects an accurate measurement, the ExacTemp light is continuously on, a long beep signals the end of the measurement, and the display shows the result.

- If the probe is positioned incorrectly in the ear canal or is moved during the measuring process, the ExacTemp light goes out, a sequence of short beeps sounds, and the error message POS (position error) appears.
7. When you are finished taking the temperature, press the ejector button to eject the used probe cover.
  8. Return the thermometer to the accessory dock.

After the transfer is complete, the temperature and the temperature scale appear on the Home tab according to the monitor settings.



**NOTE** Only the latest measurement is transferred to the monitor.



**NOTE** Measurements that have already been transferred to the monitor cannot be transferred again.

For more information about thermometer functionality, refer to the thermometer manufacturer's instructions for use.

## Change the temperature scale on the ear thermometer

To switch from Celsius to Fahrenheit, refer to the thermometer manufacturer's instructions for use.

## Charge the ear thermometer battery

To charge the battery pack:

- Place the thermometer in the accessory dock.
- Make sure that the monitor is connected to AC power.
- Make sure that the monitor is powered on.

The LED on the dock indicates the charging status of the battery pack.

### PRO 6000 model

- Amber: The battery pack is charging.
- Blinking green: The battery pack is fully charged.
- Steady green: The battery pack is ready to charge, but dock is empty or thermometer is improperly docked.
- No LED/Off: Not ready to charge. The monitor is not connected to AC power and is not powered on, or the monitor has disabled charging.

### PRO 4000 model

- Green: The battery pack is charged.
- Amber: The battery pack is charging.
- No LED/Off: Not ready to charge. The monitor is not connected to AC power and is not powered on, or the monitor has disabled charging.



**NOTE** The battery pack continues to charge while the monitor is in Display power saving mode.



**NOTE** It is strongly recommended that you use only the Welch Allyn rechargeable battery pack in the thermometer because the dock cannot charge other batteries.

## Temperature mode selection

The monitor with the temperature module takes a patient temperature in either Predictive (Normal) or Direct mode. The default setting is the Predictive mode.



**WARNING** Inaccurate measurement risk. To ensure optimal accuracy, always confirm that the correct mode and site are selected.



**WARNING** Patient injury risk. Do not exceed the recommended temperature measurement durations in Direct mode. Continuous measurement durations of 3 minutes at the oral and rectal sites and 5 minutes at the axillary site are recommended for accurate measurement. Do not continuously measure beyond 10 minutes in any mode.

### Predictive mode

Is a one-time measurement that takes a temperature in approximately 6 to 15 seconds. Removing the probe from the probe well, loading a probe cover, and holding the probe tip in place at the measurement site initiates a Predictive mode measurement. The monitor sounds a tone to indicate the end of a predictive measurement.

### Direct mode

Provides continual temperature measurements. For oral and rectal measurements, it is recommended to measure temperature until the temperature stabilizes or for 3 minutes. For axillary measurements, it is recommended to measure temperature until the temperature stabilizes or for 5 minutes. The monitor changes to Direct mode approximately 60 seconds after the probe is removed from the probe well.



**NOTE** The monitor does not retain Direct mode temperatures in memory. Therefore, it is important to note the temperature before removing the probe from the measurement site and then manually record it in the patient record.

After 10 minutes of using the Direct mode, the monitor generates a technical alarm condition and clears the measurement.

## SpO<sub>2</sub>

The SpO<sub>2</sub> sensor measures oxygen saturation and pulse rate. Oxygen saturation is displayed as a percentage from zero (0) to 100%. The oxygen saturation and pulse rate are updated and refreshed each second,  $\pm 0.5$  seconds.

### SpO<sub>2</sub> frame

The SpO<sub>2</sub> frame displays data and controls used in pulse oximetry measurements.

The frame provides a numeric view and a waveform view of SpO<sub>2</sub> data. You can toggle between views by touching the left side of the frame.

### SpO<sub>2</sub> numeric view

The numeric view indicates the SpO<sub>2</sub> saturation percentage and the pulse amplitude. Features of this view differ based on the type of sensor enabled and the profile selected. The size of the SpO<sub>2</sub> frame and displayed measurements varies based on your configuration.

#### Nellcor sensor

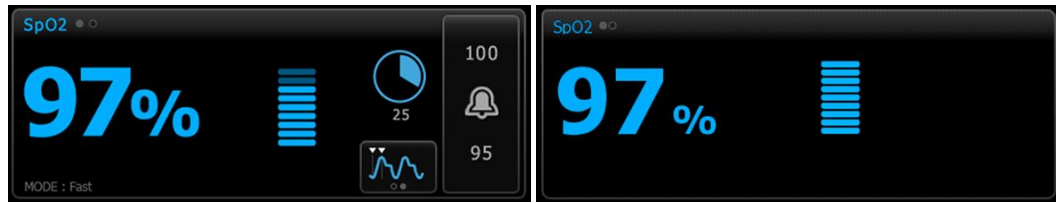

Intervals Monitoring and Continuous Monitoring profiles

Spot Check profile

**Masimo sensor**



Intervals Monitoring profile, no SpHb license

Spot Check profile



Intervals Monitoring profile, SpHb license activated



Continuous Monitoring profile

**Pulse amplitude**

The pulse amplitude bar indicates the pulse beat and shows the relative pulse strength. More bars illuminate as the detected pulse gets stronger.



**Response Mode Control**

The Response Mode Control allows you to set the SpO2 measurement time to either Normal or Fast.



## Perfusion Index

Perfusion Index (PI) is an SpO2 feature available only with Masimo-equipped monitors.

PI is a relative reading of pulse strength at the monitoring site. PI display ranges from 0.1 percent (very weak pulse strength) to 20.0 percent (very strong pulse strength). PI is a relative number and varies between monitoring sites and from patient to patient, as physiological conditions vary.

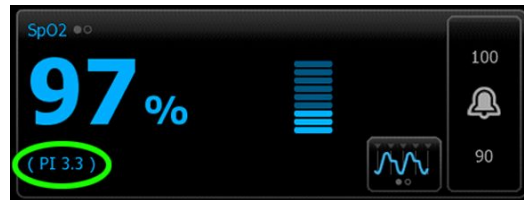

During sensor placement, the PI can be used to evaluate the appropriateness of an application site, looking for the site with the highest PI number. Placing the sensor at the site with the strongest pulse amplitude (highest PI number) improves performance during motion. Monitor the trend of the PI for changes in physiological conditions.

## SatSeconds™ alarm management

The SatSeconds feature is an SpO2 alarm management system available only with monitors that are equipped with Nellcor OxiMax Technology.

The SatSeconds feature is the product of the time and magnitude that a patient falls outside of the SpO2 alarm limits. For example, three points below the alarm limit for 10 seconds equals 30 SatSeconds. An alarm is triggered only when a desaturation event reaches the SatSeconds limit. The SatSeconds feature is clinician controlled and can be set to 0, 10, 25, 50, or 100 SatSeconds. If a desaturation event resolves on its own within the preset time, the clock will automatically reset and the monitor will not alarm.



**NOTE** The SatSeconds feature has a built-in safety protocol that sounds an alarm whenever three SpO2 violations of any amount or duration occur within a 1-minute period.

## SpO2 waveform view

The waveform view shows the SpO2 plethysmograph waveform. You can select the default SpO2 waveform sweep speed in Advanced settings, but you can change the sweep speed on the Setup tab.

For additional normalization and waveform information, refer to the manufacturer's instructions for use.

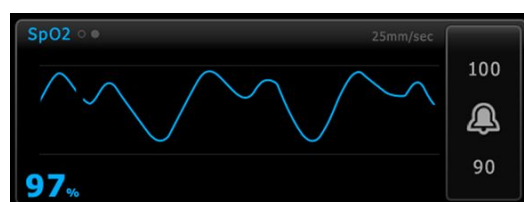



## Set up SpO2

Follow these steps to configure SpO2 parameter settings and to set up modifiers.

1. Touch the **Settings** tab.
  2. Touch the **Setup** tab.
  3. Touch the **SpO2** vertical tab.
  4. Select the desired Sweep speed.
  5. Touch the **Home** tab.
- The new setting takes effect immediately.
6. To set up modifiers, touch the **Patients** tab.
  7. Touch the **Manual** tab.
  8. Scroll through the list to find the SpO2 section, then enter or select the SpO2 modifier(s) as desired.

- SpO2 measurement site. Select the measurement site from the list box.
- O2 flow rate. Enter the flow rate using the keypad.



**NOTE** All O2 modifier selections are cleared when the O2 flow rate is changed to 0 and when the O2 method is changed to none.

- O2 concentration. Enter the concentration using the keypad.
  - O2 Method. Select the method from the list box.
9. Enter or select other modifier(s), if applicable, as desired.
  10. Touch **OK**.

The Home tab appears. In the Continuous Monitoring profile, the modifiers are saved with the next set of measurements sent to the network. In the episodic profiles, the modifiers are saved with the next set of measurements you take or with any current, unsaved measurements on the device when you touch **Save**.

## SpO2 alarm signal delays

### Configure SpO2 alarms

Follow these steps to set alarm limits for SpO2 measurements.

1. Verify that you are using the Intervals Monitoring or Continuous Monitoring profile.
2. Touch the **Alarms** tab.
3. Touch the **SpO2** vertical tab.
4. Ensure that the SpO2 alarm limit control is set to ON.



**NOTE** If any parameter's alarm limit control is set to OFF, you cannot adjust alarm limits on the Alarm tab, and no visual or audio signals will occur for that specific parameter.

5. Enter the desired upper and lower alarms limits for SpO2 using the up/down arrow keys or the keypad.

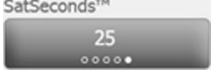
6. If your monitor is configured with a Nellcor SpO2 sensor, touch  to select a SatSeconds setting.
7. Touch the **Home** tab.  
The new alarm settings take effect immediately.

## Set Response Mode

To set the Response Mode from the Home tab, the monitor must be in the Intervals Monitoring or Continuous Monitoring profile.



Touch  in the SpO2 frame.

When Fast mode is selected, either **MODE: Fast** or **: Fast** appears in the frame.

## Measure SpO2 and pulse rate



**WARNING** Many environmental variables, including patient physiology and clinical application, can affect the accuracy and performance of the monitor. Therefore, you must verify all vital signs information, especially NIBP and SpO2, before treating the patient. If there is any question about the accuracy of a measurement, verify the measurement using another clinically accepted method.



**WARNING** Inaccurate measurement risk. Use only Masimo rainbow SET sensors and accessories on Masimo-equipped monitors.



**WARNING** Inaccurate measurement risk. Use only Nellcor sensors and accessories on Nellcor-equipped monitors.



**WARNING** High-intensity lights (including pulsating strobe lights) directed on the pulse co-oximeter can prevent it from obtaining readings.



**WARNING** The pulsations from intra-aortic balloon support can increase the pulse rate displayed on the monitor. Verify the patient's pulse rate against the ECG heart rate.



**WARNING** Inaccurate measurement risk. Venous congestion might cause a low reading of arterial oxygen saturation. Place the sensor on a hand at heart level to ensure proper venous outflow from a monitored site.



**WARNING** Inaccurate measurement risk. The pulse co-oximeter can be used during defibrillation, but the reading may be inaccurate for up to 20 seconds.



**WARNING** Patient injury risk. Do not attempt to reprocess, recondition, or modify any sensors or patient cables. Doing so might damage electrical components.



**WARNING** Pulse rate measurement might not detect certain arrhythmias because it is based on the optical detection of a peripheral flow pulse. Do not use the pulse oximeter as a replacement or substitute for ECG-based arrhythmia analysis.



**WARNING** Use the pulse co-oximeter as an early warning device. As you observe a trend toward patient hypoxemia, use laboratory instruments to analyze blood samples to better understand the patient's condition.



**WARNING** Patient injury risk. If the sensor is applied with excessive pressure for prolonged periods, a pressure injury can occur.



**WARNING** Functional testers cannot be used to assess the accuracy of a pulse oximeter monitor.



**WARNING** The accuracy of SpO<sub>2</sub> measurements can be affected by any of the following:

- elevated levels of total bilirubin
- elevated levels of Methemoglobin (MetHb)
- elevated levels of Carboxyhemoglobin (COHb)
- hemoglobin synthesis disorders
- low perfusion at the monitored site
- the presence of concentrations of some intravascular dyes, sufficient to change the patient's usual arterial pigmentation
- patient movement
- patient conditions such as shivering and smoke inhalation
- motion artifact
- painted nails
- poor oxygen perfusion
- hypotension or hypertension
- severe vasoconstriction
- shock or cardiac arrest
- venous pulsations or sudden and significant changes in pulse rate
- proximity to an MRI environment
- moisture in the sensor
- excessive ambient light, especially fluorescent
- the use of the wrong sensor
- a sensor misapplied or dislodged
- severe anemia
- venous congestion

1. Verify that the sensor cable is connected to the monitor.



**WARNING** Patient injury risk. The sensor and extension cable are intended only for connection to pulse co-oximetry equipment. Do not attempt to connect these cables to a PC or any similar device. Always follow the sensor manufacturer's instructions for care and use of the sensor.

2. Clean the application site. Remove anything, such as nail polish, that could interfere with sensor operation.



**NOTE** Do not use disposable sensors on patients who have allergic reactions to the adhesive.

3. Attach the sensor to the patient according to the manufacturer's instructions for use, observing all warnings and cautions.



**WARNING** Patient injury and inaccurate measurement risk. Do not use tape to secure the sensor to the patient. This can restrict blood flow, damage the patient's skin, cause inaccurate readings, and damage the sensor.



**WARNING** Patient injury risk. Exercise caution when applying a sensor to a patient with compromised skin integrity. Applying tape or pressure to compromised sites can reduce circulation and cause additional skin damage.



**NOTE** If a sterile sensor is required, select a sensor that has been validated for sterilization, and follow the sensor manufacturer's instructions for sterilizing the sensor.

Place the sensor and the NIBP cuff on different limbs to reduce unnecessary alarms when you monitor these parameters at the same time.



**NOTE** A range of sensors is available for different patient sizes and measurement sites. Consult the sensor manufacturer's instructions for selecting the correct sensor.

4. Confirm that the monitor displays SpO<sub>2</sub> and pulse rate data within 15 seconds of connection to the patient.



**WARNING** Patient injury risk. Incorrect sensor application or excessive duration of sensor use can cause tissue damage. Inspect the sensor site periodically as directed in the sensor manufacturer's instructions.

While SpO<sub>2</sub> is being measured, the displayed pulse rate is derived from the sensor. If SpO<sub>2</sub> is not available, the pulse rate is derived from NIBP.

If SpO<sub>2</sub> is being measured continuously on a patient for an extended period, change the sensor location at least every three hours or as indicated by the sensor manufacturer's instructions.



**NOTE** In the Intervals Monitoring and Continuous Monitoring profiles, removing the SpO<sub>2</sub> sensor from the patient triggers the following responses:

- The last SpO<sub>2</sub> saturation measurement captured before the sensor was removed remains on the display for approximately 10 seconds and then is cleared.
- If SpO<sub>2</sub> physiological alarm limits are ON, when the saturation measurement is cleared, a "Searching for pulse signal" technical alarm occurs.
- If SpO<sub>2</sub> physiological alarm limits are OFF, when the saturation measurement is cleared, no physiological or technical alarms occur.

## SpHb

Monitors configured with Masimo total hemoglobin can measure hemoglobin (SpHb), SpO<sub>2</sub>, and pulse rate. SpHb monitoring continuously measures blood constituents and anemic status in a patient through a noninvasive SpHb pulse co-oximeter.

## SpHb frame

The SpHb frame displays data and controls used in total hemoglobin measurements.



**NOTE** SpHb is available only in the Intervals Monitoring and Continuous Monitoring profiles.

In this frame, one of two labels appears:

- **SpHbv** indicates the venous calibrated reference for total hemoglobin measurement.
- **SpHb** indicates the arterial calibrated reference for total hemoglobin measurement.

You can specify the reference source in Advanced settings.

The frame provides a numeric view and a graphical trend view of total hemoglobin data. You can toggle between views by touching the left side of the frame.

## SpHb numeric view

The numeric view indicates the total hemoglobin level in either grams per deciliter (g/dL) or millimoles per liter (mmol/L). You can select the unit of measure in Advanced settings. The size of the SpHb frame and displayed measurements varies based on your configuration.



## Averaging

The averaging button enables you to select the moving window of time used by the parameter to calculate the SpHb value and update the display: short (approximately 1 minute), medium (approximately 3 minutes), or long (approximately 6 minutes).



## SpHb graphical trend view

The graphical trend view presents a trend of the measurements over a user-selected period. You can select the period displayed on the Setup tab. The size of the SpHb frame and displayed trend varies based on your configuration.



The graph shows total hemoglobin level on the y-axis and time on the x-axis (oldest measurements on the left to newest measurements on the right). The entire graph updates every 10 seconds.

To the right of the graph, the frame displays the current measurement in numeric format.

## Set up SpHb

Follow these steps to configure SpHb parameter settings.

1. Touch the **Settings** tab.
2. Touch the **Setup** tab.
3. Touch the **SpHb** vertical tab.
4. Select the desired Trend period.
5. Touch the **Home** tab.

The new settings take effect immediately.

## Configure SpHb alarms

Follow these steps to set alarm limits for SpHb measurements.

1. Verify that you are using the Intervals Monitoring or Continuous Monitoring profile.
2. Touch the **Alarms** tab.
3. Touch the **SpHb** vertical tab.
4. Ensure that the SpHb alarm limit control is set to ON.



**NOTE** If any parameter's alarm limit control is set to OFF, you cannot adjust alarm limits on the Alarm tab, and no visual or audio signals will occur for that specific parameter.

5. Enter the desired upper and lower alarm limits for SpHb using the up/down arrow keys or the keypad.
6. Touch the **Home** tab.

The new alarm settings take effect immediately.

## Set SpHb averaging mode



Touch  in the SpHb frame.

The SpHb frame displays the current mode.

## Measure SpHb



**WARNING** Inaccurate measurement risk. Use only Masimo rainbow SET sensors and accessories on Masimo-equipped monitors.



**WARNING** High-intensity lights (including pulsating strobe lights) directed on the pulse co-oximeter can prevent it from obtaining readings.



**WARNING** The pulsations from intra-aortic balloon support can increase the pulse rate displayed on the monitor. Verify the patient's pulse rate against the ECG heart rate.



**WARNING** Inaccurate measurement risk. Venous congestion might cause a low reading of arterial oxygen saturation. Place the sensor on a hand at heart level to ensure proper venous outflow from a monitored site.



**WARNING** Inaccurate measurement risk. The pulse co-oximeter can be used during defibrillation, but the reading may be inaccurate for up to 20 seconds.



**WARNING** Patient injury risk. Do not attempt to reprocess, recondition, or modify any sensors or patient cables. Doing so might damage electrical components.



**WARNING** Pulse rate measurement might not detect certain arrhythmias because it is based on the optical detection of a peripheral flow pulse. Do not use the pulse oximeter as a replacement or substitute for ECG-based arrhythmia analysis.



**WARNING** Use the pulse co-oximeter as an early warning device. As you observe a trend toward patient hypoxemia, use laboratory instruments to analyze blood samples to better understand the patient's condition.



**WARNING** The accuracy of SpHb measurements can be affected by any of the following:

- elevated levels of total bilirubin
- elevated levels of Methemoglobin (MetHb)
- elevated levels of Carboxyhemoglobin (COHb)
- hemoglobin synthesis disorders
- low perfusion at the monitored site
- the presence of concentrations of some intravascular dyes, sufficient to change the patient's usual arterial pigmentation
- patient movement
- patient conditions such as shivering and smoke inhalation
- motion artifact
- painted nails
- poor oxygen perfusion
- hypotension or hypertension
- severe vasoconstriction
- shock or cardiac arrest
- venous pulsations or sudden and significant changes in pulse rate
- proximity to an MRI environment
- moisture in the sensor
- excessive ambient light, especially fluorescent
- the use of the wrong sensor
- a sensor misapplied or dislodged
- severe anemia
- venous congestion

1. Verify that the sensor cable is connected to the monitor.



**WARNING** Patient injury risk. The sensor and extension cable are intended only for connection to pulse co-oximetry equipment. Do not attempt to connect these cables to a PC or any similar device. Always follow the sensor manufacturer's instructions for care and use of the sensor.

2. Verify that you are using the Continuous or Intervals profile.
3. Clean the application site. Remove anything, such as nail polish, that could interfere with sensor operation.



**NOTE** Do not use disposable sensors on patients who have allergic reactions to the adhesive.

4. Attach the sensor to the patient according to the manufacturer's instructions for use, observing all warnings and cautions.



**WARNING** Patient injury and inaccurate measurement risk. Do not use tape to secure the sensor to the patient. This can restrict blood flow, damage the patient's skin, cause inaccurate readings, and damage the sensor.



**WARNING** Patient injury risk. Exercise caution when applying a sensor to a patient with compromised skin integrity. Applying tape or pressure to compromised sites can reduce circulation and cause additional skin damage.



**NOTE** If a sterile sensor is required, select a sensor that has been validated for sterilization, and follow the sensor manufacturer's instructions for sterilizing the sensor.

Place the sensor and the NIBP cuff on different limbs to reduce unnecessary alarms when you monitor these parameters at the same time.



**NOTE** A range of sensors is available for different patient sizes and measurement sites. Consult the sensor manufacturer's instructions for selecting the correct sensor.

5. Confirm that the monitor displays SpHb or SpHbv data after connection to the patient.



**WARNING** Patient injury risk. Incorrect sensor application or excessive duration of sensor use can cause tissue damage. Inspect the sensor site periodically as directed in the sensor manufacturer's instructions.

While SpHb is being measured, the displayed SpO<sub>2</sub> and pulse rate are derived from the same sensor. If SpO<sub>2</sub> is not available, the pulse rate is derived from NIBP.

Detaching the sensor during a measurement triggers an alarm.

If SpHb is being measured continuously on a patient for an extended period, change the sensor location at least every three hours or as indicated by the sensor manufacturer's instructions.

## ECG

1. If you haven't done so already, connect the ECG module to the host Connex device. (See "Mount and connect the ECG module" in the Setup section.)

After the device boots up, if Continuous Monitoring is the default profile, the ECG frame will appear on the Home tab, showing that the device is ready to acquire ECG.

2. If the default profile is something other than Continuous monitoring, follow the instructions in "Change to the Continuous Monitoring profile" before proceeding.
3. Follow the guidance and instructions later in this section for connecting the patient cable, placing leads, and acquiring ECG and Impedance Respiration readings.

## Interface overview

These sample screens show how the ECG/Impedance Respiration module displays physiological information on the host Connex device.



### ECG frame

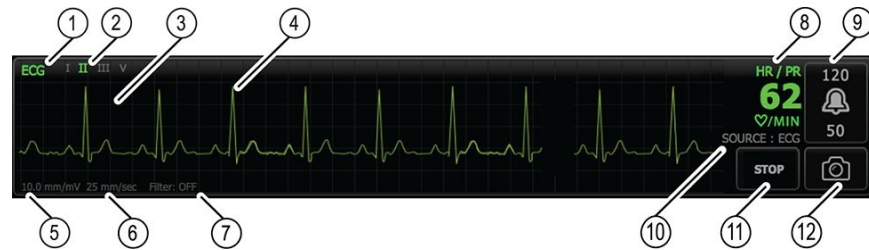

Item	Description	Item	Description
1	ECG frame	7	Filter label
2	Lead toggle and label. Green lead is displayed.	8	Heart rate/Pulse rate label
3	ECG grid	9	Heart rate/Pulse rate alarm limit controls
4	ECG waveform	10	Heart rate/Pulse rate source label
5	Gain setting label	11	Start/Stop ECG button
6	Sweep speed label	12	Waveform snapshot button

### Respiration Rate frame



Item	Description
1	Respiration Rate frame
2	Respiration source label
3	Respiration alarm limit controls

### Set up ECG/Impedance Respiration

Follow these steps to configure ECG parameter options.



**WARNING** Arrhythmia detection (for V-Tach, V-Fib and asystole) and impedance respiration are not intended for neonatal patients.

1. Touch the **Settings** tab.
2. Touch the **Setup** tab.
3. Touch the **ECG** vertical tab.
4. Adjust the following settings as desired:
  - ECG Gain. Select the desired gain.
  - Sweep speed. Select the desired sweep speed (25 mm/s or 50 mm/s).



**NOTE** The display sweep speed matches the printout sweep speed.

- Filter. Touch the selection box to enable or disable Filter.



**WARNING** Inaccurate measurement risk. In normal measurement conditions, enabling the filter might suppress the QRS complexes too much and thus interfere with ECG analysis.

- Use ECG as the RR source when available. Touch the selection box to enable or disable Impedance Respiration.



**WARNING** Inaccurate measurement risk. Use of respiration monitoring by impedance pneumography can affect the operation of some pacemakers. If pacemaker operation is affected, turn off respiration pneumography.

5. Set Pacemaker detection as needed. Touch the selection box to enable or disable the display of pacemaker spike markers, as shown here.



**WARNING** Patient safety risk. Correctly set pacemaker detection. A pacemaker pulse can be counted as a QRS, which could result in an incorrect heart rate and failure to detect cardiac arrest and some life-threatening arrhythmias (V-Tach, V-Fib, and asystole). If your patient has a pacemaker, turn pacemaker detection ON to avoid this hazard, and keep pacemaker patients under close observation.



**NOTE** The default setting is Pacemaker detection Off. After monitoring a patient with Pacemaker detection On, the device returns to the default before monitoring the next patient. Return to the **Settings** > **Setup** > **ECG** tab to enable Pacemaker detection for new patients.

6. Touch the **Home** tab.  
The new settings take effect immediately.

## Lead placement overview



**WARNING** Patient safety risk. To minimize interference and the danger of burns to the patient, use only approved ECG cables. Keep the ECG cable as far away as possible from any electrosurgical cables. Make sure that the electrosurgical return conductor (neutral) is properly attached to the patient and makes a good contact.

Proper lead placement is important for a successful ECG. The most common ECG problems are caused by poor electrode contact and loose leads.

The following table shows the relationships between IEC and AHA leads as well as their placement.

IEC Lead	IEC Color	AHA Lead	AHA Color	Placement
R	Red	RA	White	Right arm
L	Yellow	LA	Black	Left arm
F	Green	LL	Red	Left leg
C or C1	White	V or V1	Brown	4th intercostal (IC) space at right border of the sternum
N	Black	RL	Green	Right leg

### Lead placement, 3-lead

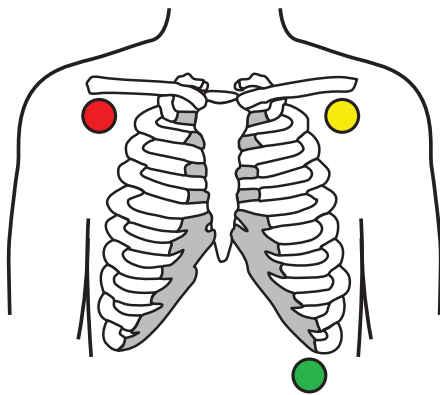

IEC

- R - Red
- L - Yellow
- F - Green

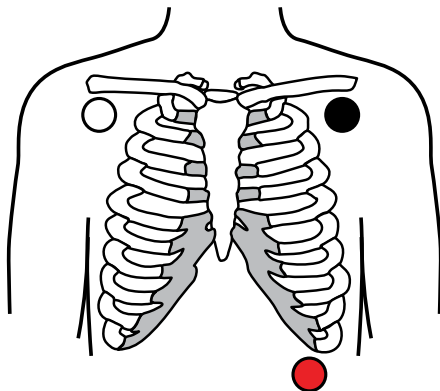

AHA

- RA - White
- LA - Black
- LL - Red

### Lead placement, 5-lead

IEC

- N - Black

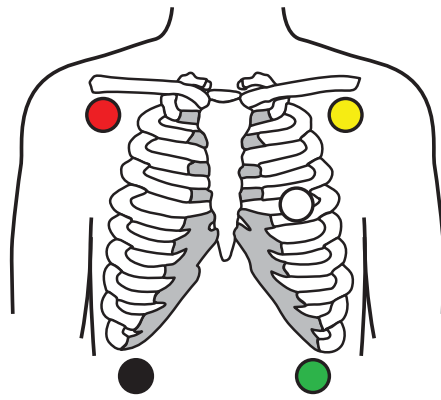

- R - Red
- L - Yellow
- C - White
- F - Green

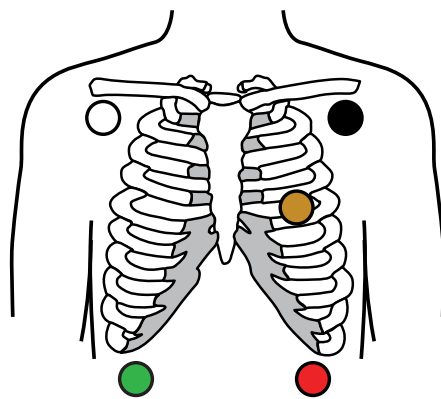

- AHA
- RL - Green
- RA - White
- LA - Black
- V - Brown
- LL - Red

### Impedance respiration

In some patients, impedance respiration detection may be inadequate using the standard ECG electrode placement. In these cases, change the F and R (IEC) or LL and RA (AHA) electrode placement to the mid-axillary line on each side of the chest as shown in the illustrations.



**NOTE** Respiration can only be acquired from Lead II.

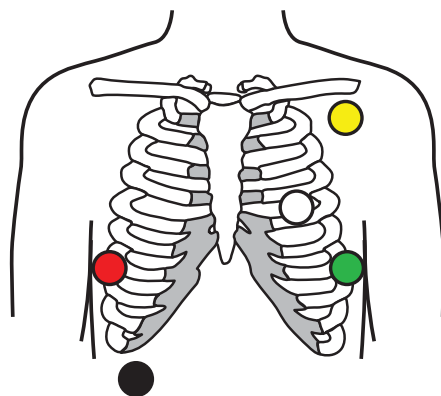

- IEC
- N - Black
- R - Red
- L - Yellow
- C - White
- F - Green

AHA

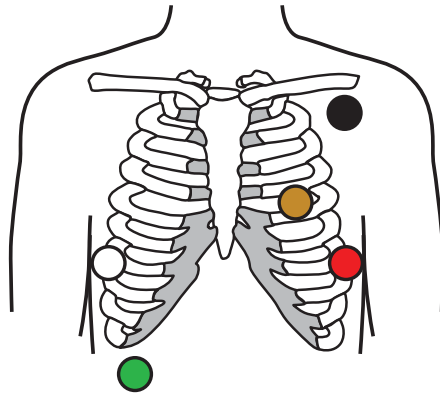

RL - Green  
 RA - White  
 LA - Black  
 V - Brown  
 LL - Red

## Attach the leads to the patient

Proper lead attachment is important for a successful ECG. The most common ECG problems are caused by poor electrode contact and loose leads. Follow your local procedures for attaching the leads to the patient. Here are some common guidelines.



**WARNING** Electrodes can cause allergic reactions. To avoid this, follow the electrode manufacturer's instructions.



**WARNING** Skin irritation may result from the continuous application of the ECG electrodes. Examine the skin for signs of irritation or inflammation and avoid placing the electrode in those areas. If you observe skin irritation, replace the electrodes or change the location of the electrodes every 24 hours.



**WARNING** Connect patient lead wires only to the patient electrodes.



**WARNING** Patient safety risk. The most important aspect of obtaining a quality electrocardiogram is a proper electrode hook-up. Failure to properly apply the electrodes and patient cable may result in noisy signal, false alarms, or sub-optimal electrocardiogram analysis, which could cause patient harm. Any of these events could potentially contribute to patient harm.



**WARNING** Patient injury risk. Use only accessories approved by Welch Allyn, including electrodes, lead wires, and patient cables. These approved accessories are required for electrical protection of the patient during cardiac defibrillation. Refer to the accessory list or [parts.hillrom.com](http://parts.hillrom.com).



**WARNING** Inaccurate measurement risk. Impedance respiration monitoring is not reliable when ECG electrodes are placed on the limbs.

### To attach the leads to the patient

1. Prepare the patient.
  - Describe the ECG procedure. Explain the importance of holding still during the test. (Movement can create artifact.)
  - Verify that the patient is comfortable, warm, and relaxed. (Shivering can create artifact.)
  - Put the patient in a supine position.

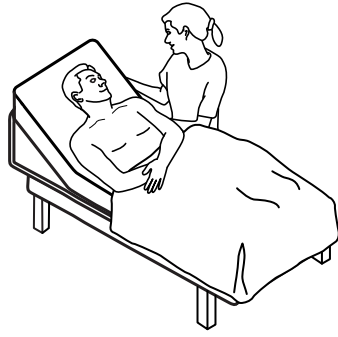

2. Prepare the electrode locations.
  - Shave and gently abrade the areas where you will place the electrodes. Take care not to compromise skin integrity.
  - Thoroughly clean the skin, and lightly rub it dry. You may use soap and water, isopropyl alcohol, or skin preparation pads.
3. Confirm that the patient cable is attached to the module, and then snap the lead wire to each the electrode.
4. Apply the electrodes (disposable or reusable) to the patient according to the "Lead placement overview" presented earlier in this section.
  - **For reusable electrodes:** Use electrode paste, gel, or cream to cover an area the size of each electrode but no larger.



**NOTE** Check for buildup of materials on reusable electrodes which can reduce waveform quality.

- **For all disposable electrodes:** Lightly tug on the connector to ensure that the lead is securely attached. If the electrode comes off, replace it with a new electrode. If the connector comes off, reconnect it.



**WARNING** Patient injury risk. To prevent cross-contamination and the spread of infection:

- Dispose of single-patient use components (for example, electrodes) after use.
- Regularly clean and disinfect all components that come in contact with patients.
- Reprocess the device accessories (for example, patient cable, leads, and reusable electrodes) between patients.



**NOTE** To maintain the quality of signals during long-term monitoring, replace the electrodes at least every 48 hours. Over longer periods, the electrode gel can dry out and the patient's skin can be irritated by the gel or adhesive. When replacing the electrodes, do not position the new electrodes on exactly the same locations, but a little to the side of the original position.

## Monitor the patient

1. Touch **Start** in the ECG frame to begin acquiring an ECG waveform. Allow 3 to 5 seconds to pass before the waveform appears onscreen. The Heart Rate also appears in the ECG frame.
2. Locate the ECG lead label in the frame. Look for a list of available leads with the current lead selection highlighted.
3. To display a different lead, touch the screen anywhere on the waveform. The waveform and lead selection label change with each touch.
4. Continue monitoring ECG as needed.



## Save and review a waveform snapshot

### Non-alarming waveform snapshots

You can save snapshots of non-alarming waveforms to the Review tab. Non-alarming waveform snapshots capture 7 seconds of data before the request.



**NOTE** You can capture one waveform snapshot per minute.

1. When you observe a waveform you want to capture, touch  in the ECG frame.  
A "Snapshot save successful" message appears to confirm a successful waveform capture.
2. Touch the **Review** tab and observe the saved waveform icon  in the ECG row.
3. To open and review the waveform snapshot, touch .
4. Touch **Print** to print the waveform or **Cancel** to close the snapshot.  
Both selections return you to the Review tab.

### Alarm waveform snapshots

Arrhythmia (V-Tach, V-Fib, and asystole) alarm waveform snapshots are saved automatically to the Review tab. No user action is required.

Waveform snapshot characteristics:

- If "Print on alarm" has been enabled in Advanced settings, the waveform prints automatically after saving is complete.
- The saved waveform icon for an alarm condition appears red  in the Review table, indicating a high priority alarm.
- Alarm waveforms capture the 7 seconds before as well as the 7 seconds after an alarm event (V-Tach, V-Fib, and asystole).
- During the 7-second post-alarm save time, you cannot modify any settings (leads, filter, gain, pacemaker detection, etc.).

## Pause continuous monitoring (Pause mode)

You can temporarily pause continuous monitoring and retain patient data on the device when your patient needs to ambulate, use the restroom, or go off the unit for a test. You can also Pause monitoring to replace ECG electrodes on your patient.



**NOTE** If a low-battery alarm occurs on the device, Pause mode is not available.



**NOTE** While in Pause mode, the device retains previously stored patient data, but it does not display this data or store additional patient measurements until you exit Pause mode.

- Touch **Pause** on the Home tab.  
A "Pause" dialog appears, indicating that you have paused continuous monitoring. Controls on this screen provide options to resume or end monitoring. A countdown timer displays the time remaining before continuous monitoring resumes.



**NOTE** You can configure the Pause Mode timeout in Advanced settings.

- To increase the pause interval, repeatedly touch the **+** symbol until the desired length of time appears.  
The pause interval is automatically applied.
- Either unsnap the electrodes from the leads or remove the electrodes from the patient as needed.
- Unsnap the electrodes if the patient needs to ambulate, use the restroom, or go off the unit.
- Remove the electrodes if you are pausing to replace the electrodes with new ones.

## Resume continuous monitoring

You can resume continuous monitoring after a pause when patient sensors are connected to a patient. The status of the pause timer determines your next step.

### Pause time remaining

If the pause time limit has not expired (time remains on the countdown timer), resume monitoring as follows:

1. Reconnect patient sensors to the patient as needed.
2. Touch **Resume monitoring**.

The Home tab appears and continuous monitoring resumes.

### Pause time limit expired (patient sensors connected)

If the pause time limit has expired and you have already reconnected patient sensors to the patient and/or the device, the Home tab appears and continuous monitoring automatically resumes.

### Pause time limit expired (patient sensors disconnected)

If the pause time limit runs out before you resume monitoring, the device exits Pause mode, and alarms might occur.

Reconnect patient sensors to the patient and/or device and acknowledge alarm and information messages as needed.

Continuous monitoring resumes.

## Stop ECG measurement

Follow these steps to stop ECG monitoring.



**NOTE** You may continue to monitor other parameters when you stop ECG monitoring, or you can stop monitoring all parameters along with ECG.

1. To stop only ECG measurement, touch **STOP** in the ECG frame.  
The ECG module stops collecting data.
2. To stop all parameter measurements, including ECG, touch **Pause**, and then touch **End monitoring**.
3. Detach the electrodes from your patient, and then unsnap the electrodes from the lead wires.



4. Dispose of single-use electrodes. Follow manufacturer's instructions for cleaning reusable electrodes.

## Pulse rate frame

The Pulse rate frame displays data, information, and controls used in reading pulse rates.

Pulse rate is derived from one of three sensors based on your configuration: the SpO2 sensor, the NIBP sensor, or the EarlySense sensor. The source of Pulse rate measurements appears in the lower left corner of the frame.



**WARNING** Inaccurate measurement risk. Pulse rate measurements generated through the blood pressure cuff or through SpO2 are subject to artifact and might not be as accurate as heart rate measurements generated through ECG or through manual palpation.



**NOTE** You can specify pulse tone volume in the Pulse rate vertical tab (located in the **Settings** > **Setup** tab).

## Continuous Monitoring profile

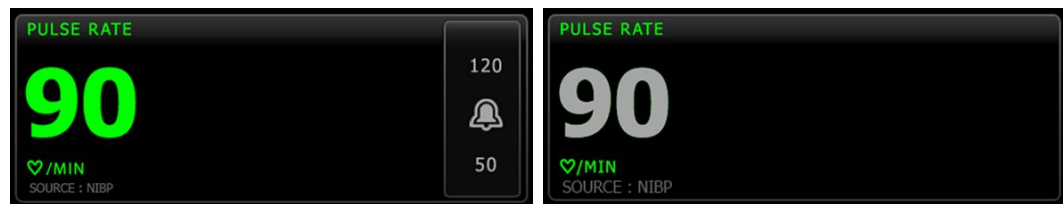

The size of the pulse rate frame and displayed measurements varies based on your configuration.

The Continuous Monitoring profile also provides a visual indication of aging episodic measurements (those more than 16 minutes old). When a pulse rate measurement derived from NIBP is displayed for more than 16 minutes, the numeric on the screen changes from its current color to gray. (See the timestamp in the NIBP frame for actual time of this measurement.) After one hour, this measurement is cleared from the frame.

## Intervals Monitoring profile

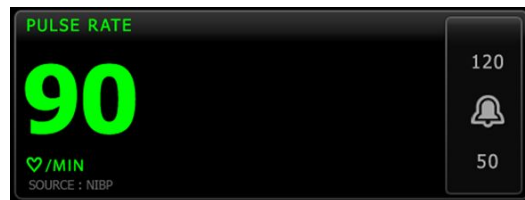

## Spot Check profile



## Set up pulse rate

Follow these steps to configure pulse rate parameter settings.

1. Touch the **Settings** tab.
2. Touch the **Setup** tab.
3. Touch the **Pulse rate** vertical tab.
4. Select the desired Tone volume.
5. Touch the **Home** tab.

The new settings take effect immediately.

## Configure pulse rate alarms

Follow these steps to set alarm limits for pulse rate.

1. Verify that you are using the Intervals Monitoring or Continuous Monitoring profile.
2. Touch the **Alarms** tab.
3. Touch the **Pulse rate** vertical tab.
4. Ensure that the Pulse rate alarm limit control is set to ON.



**NOTE** If any parameter's alarm limit control is set to OFF, you cannot adjust alarm limits on the Alarm tab, and no visual or audio signals will occur for that specific parameter.

5. Enter the desired upper and lower alarm limits for pulse rate using the up/down arrow keys or the keypad.
6. Touch the **Home** tab.

The new alarm settings take effect immediately.

## Manual parameters frame

The Manual parameters frame, located in the lower right of the Home tab, supports manual entry of parameters and displays measurements taken by some accessories.



**NOTE** In the Continuous Monitoring and Interval Monitoring profiles, Body mass index (BMI) is only available with an attached weight scale that calculates BMI and transfers it to the monitor. In the Spot and Office profiles, BMI is calculated based on weight and height values that you enter manually on the device or that an attached weight scale transfers to the monitor.



**NOTE** When a measurement is transferred from an attached weight scale to the device, the measurement displayed on the device is within one decimal place (0.1) of the measurement displayed by the weight scale.



**NOTE** You cannot manually enter temperature in this frame on a device configured with a SureTemp Plus temperature module.



**NOTE** You cannot manually enter respiration rate in this frame on a device configured with CO2, RRa, or EarlySense.

## Enter manual parameters



**NOTE** The Manual parameters frame enables you to enter measurements taken manually and displays measurements taken by some accessories. You can select and configure the parameters in Advanced settings. Only four parameters appear in the Manual parameters frame.



**CAUTION** Weight scales attached to this device must be running on battery power (battery type is specified in the weight scale manufacturer's instructions for use). Do not use the weight scale's external power supply.



**CAUTION** Before weighing a patient on any weight scale connected to the device, disconnect all sensors from the patient. Doing so ensures an accurate weight measurement and significantly reduces electrostatic discharges that might disrupt the device.

1. From the Home tab, touch anywhere within the Manual parameters frame.

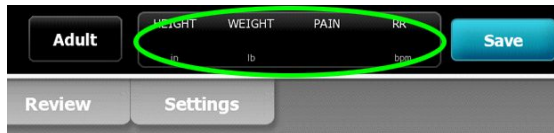

The Manual tab appears.

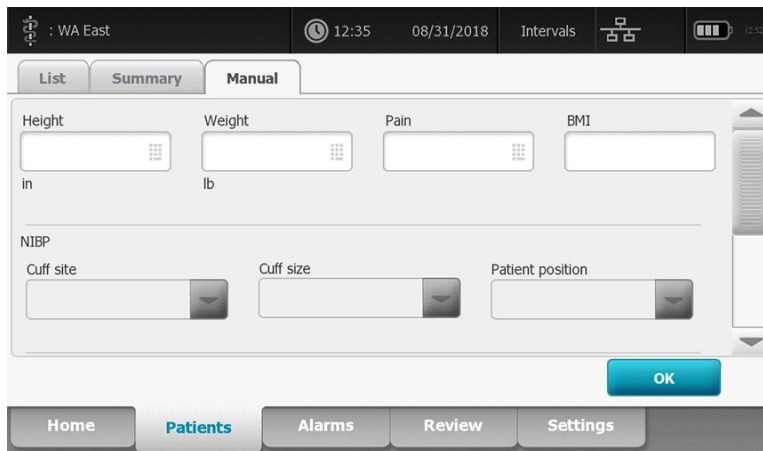

2. Touch the keypad icon in selected fields to open the numeric keypad, and then manually adjust height, weight, pain level, temperature, respiration rate, or other parameters.



**NOTE** If an approved, battery-powered weight scale is attached to the device, the device behaves as follows:

- In the Office profile, the device calculates BMI based on weight and height input transferred from the scale and displays those values in the BMI frame of the Home tab. You can adjust weight and height measurements in this frame, and BMI will recalculate based on those changes.
- In the Spot profile, the device calculates BMI based on weight and height transferred from the scale and displays those values on the Patients > Manual tab and in the Manual parameters frame of the Home tab if BMI is selected for display. If the scale calculates BMI, that value is transferred to the device. You can adjust weight and height measurements on the Manual tab, and BMI will recalculate based on those changes.
- In the Continuous Monitoring and Intervals Monitoring profiles, the device receives height and weight values from the scale and displays those values on the Patients > Manual tab and in the Manual parameters frame of the Home tab if BMI is selected for display. If the scale calculates BMI, the scale transfers that value to the device. You can adjust weight and height measurements on the Manual tab, but if you do, the read-only BMI field will clear.



**NOTE** Ensure that the current patient ID is correct before saving.

3. Touch **OK** to confirm settings and return to the Home tab.



**NOTE** In the Intervals Monitoring and Spot Check (episodic) profiles, manual parameters clear from the Home tab after a successful save.



**NOTE** When the device is connected to a central station and in the Continuous Monitoring profile, all manual parameters except temperature will be sent to the central station when you touch **OK**.

## Physical assessment instrument handles

### Use the physical assessment instrument handles

The handles supply power to Welch Allyn 3.5V instruments. This section focuses on operation of the handles only. Refer to the instructions for use for each instrument head to use it properly.



**NOTE** Handle modules are available only in the 84- and 85-series models.

Ensure the wall system is plugged in.

1. Lift the handle you want to use from the handle cradle.

The instrument will automatically power on when you remove it from the handle cradle. Only one handle is powered at a time.

2. Attach a specula to the end of the instrument head if appropriate.
3. Adjust light output by turning the rheostat on the handle.
  - Turning the rheostat clockwise increases the light output.

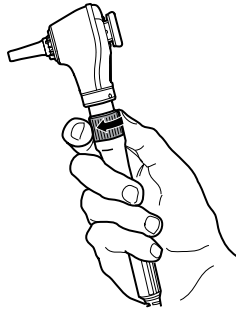

- Turning the rheostat counterclockwise decreases the light output.



**NOTE** The rheostat does not power down the instrument when you turn it counterclockwise as far as it will go.

4. Follow the instructions for use for the instrument head when examining a patient.



**CAUTION** Do not overstretch the cords on these handles to prevent damage. Always examine patients within a comfortable reach of the wall system to protect the cords.



**CAUTION** To minimize the external housing temperature of the diagnostic instrument heads, on-time should not exceed 2 minutes, and off-time should be a minimum of 10 minutes.

5. Return the handle to the handle cradle.

Placing the handle in the cradle disengages the OptiSense™ optical sensor and powers down the instrument.



**NOTE** The handles continue to receive power as long as the wall system is plugged in, has a charged and functioning battery, and is powered on. You can power down the handles by powering down the entire wall system. See the Startup section for details.



## Maintenance and service

---

### Perform periodic checks

Welch Allyn recommends that each facility conduct periodic checks of each monitor.

1. Check the following at least daily:
  - Audio, especially at startup
  - Fan, especially at startup
  - Touchscreen alignment
  - Date
  - Time
2. Visually inspect the following at least weekly:
  - The monitor for any damage or contamination
  - The AC cord for exposed copper
  - All cables, cords, and connector ends for damage or contamination
  - All mechanical parts, including covers, for integrity
  - All safety-related labeling for legibility and adhesion to the monitor
  - All accessories (cuffs, tubing, probes, sensors) for wear or damage
  - Documentation for current revision of the monitor
3. Do the following at least monthly:
  - Test the speaker by selecting each alarm volume level and listening for the different tones
  - Visually inspect the mobile stand wheels for wear and faulty operation
  - Visually inspect the mounting screws on the wall or cart for looseness and wear
4. Perform annual checks of the system and modules using the Welch Allyn Service Tool.

Update settings, replace items, or call for service as necessary based on results of visual inspection. Do not use the monitor if you see any signs of damage. Qualified service personnel must check any monitor that is damaged for proper operation before putting the monitor back into use.



**WARNING** Electric shock hazard. Never perform maintenance or service tasks while the device is connected to a patient.



**CAUTION** Wall system components shall be replaced by Welch Allyn service centers or qualified service personnel.

### Replace the printer paper (Connex VSM)

The printer is located on the top of the monitor. Follow these steps to replace the roll of printer paper:

1. Grasp the two tabs and pull up to open the printer door.

2. Remove the empty core.



**WARNING** Hot surface. Do not touch the printer mechanism.

3. Insert a new roll of paper.



**NOTE** The paper roll must be installed so that it unwinds from the bottom of the roll, as illustrated. If the paper roll is not installed correctly, the printer will not print properly.

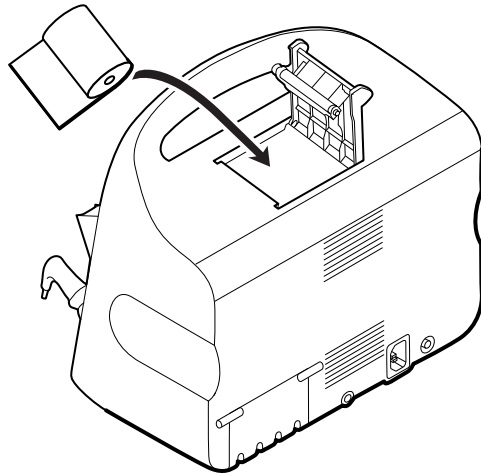

4. Advance the end of the roll past the roller so that it extends past the printer door, as shown.

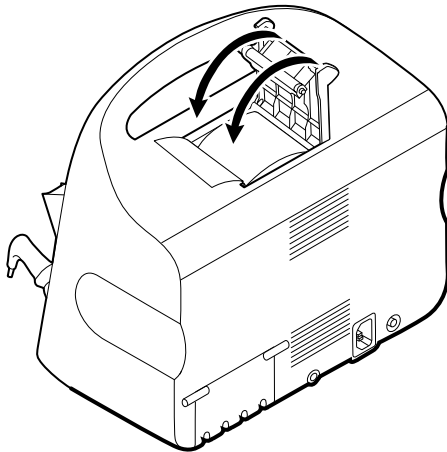

5. With one hand, pull lightly on the paper to take up any slack. With the other hand, close the printer door by pushing it down and into place until it clicks.

Be certain that the paper does not catch in the printer door.

## Change the battery (Connex VSM)

Before removing the battery, shut down the monitor.

1. Turn the monitor upside down to access the battery cover.



2. Locate the battery cover, indicated by .
3. Insert a coin into the slot and push to open. Choose a coin that fits comfortably in the slot.

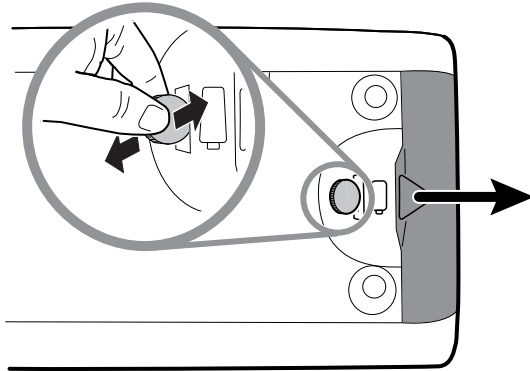

4. Pull the battery out by pulling the battery label, which is visible when you open the battery cover.

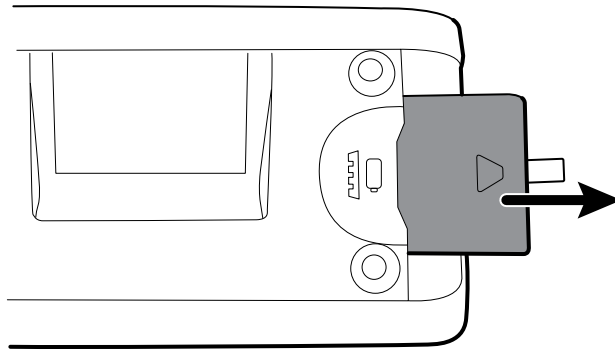

5. Slide in the new battery. Ensure that you insert the new battery in the same orientation as the old battery.

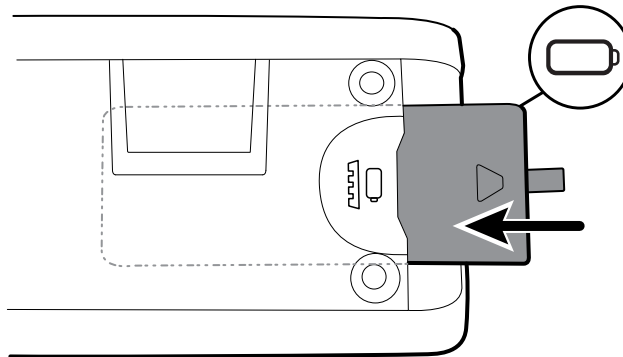

6. Replace the battery cover by positioning the end below  and then pressing firmly on the opposite end.



**WARNING** Risk of fire, explosion, and burns. Do not short-circuit, crush, incinerate, or disassemble the battery pack. Never dispose of batteries in refuse containers. Always recycle batteries according to local regulations.



**NOTE** New batteries are only 30 percent charged. Therefore, connect the monitor to AC power immediately after inserting a new battery.

## Remove the wall system from the wall (Connex IWS)

For maintenance or service activities that require access to the back of the wall system, follow these steps to remove the wall system from the wall.

1. Touch the **Settings** tab.
2. Touch the **Device** tab.
3. Touch **Power down**.
4. Remove all instrument heads, detach all accessible cords and cables, and unplug the power cord from the outlet.
5. Remove the cover by loosening the captive retention screws.

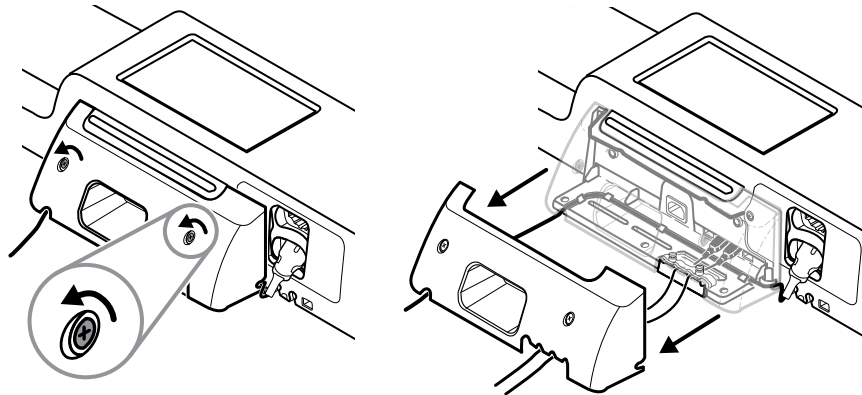

6. If USB accessories are connected, loosen the two screws on the cable retention clamp and remove it, then disconnect all USB cables.

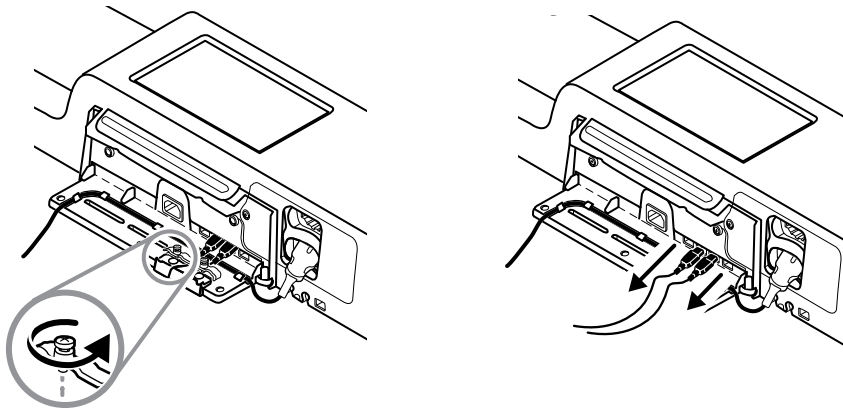

7. If the wall system is configured with SpO2, disconnect the SpO2 cable and remove it from the channel on the bottom of the wall system.

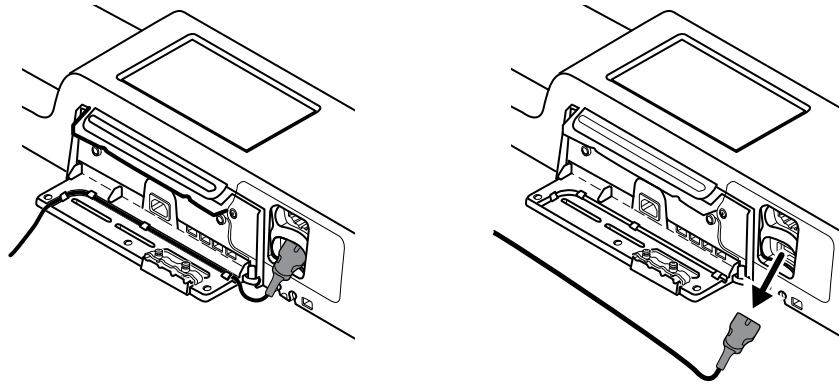

8. Remove the security screw at the bottom of the wall system.

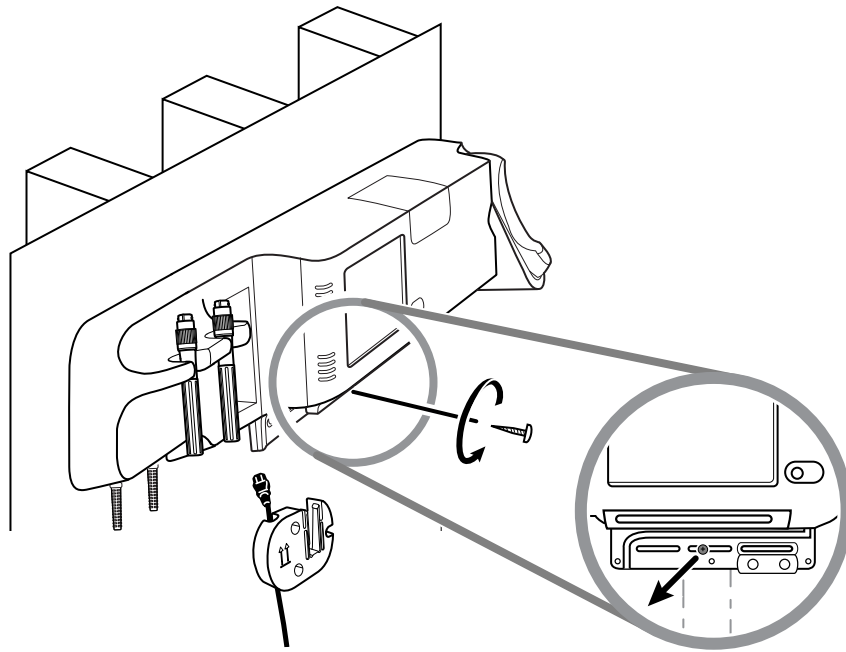

9. Carefully lift the wall system off the mounting rail bracket and place it onto a table or flat work surface.

## Change the battery (Connex IWS)

Before removing the battery, follow the instructions to remove the wall system from the wall.

1. Place the wall system on a table or flat work surface so that the back of the wall system faces up.
2. Locate the battery, indicated by .
3. Remove the battery.
4. Insert the new battery. Ensure that you insert the new battery in the same orientation as the old battery.

- Mount the wall system on the wall using the instructions presented in the Setup section of this instructions for use.



**WARNING** Risk of fire, explosion, and burns. Do not short-circuit, crush, incinerate, or disassemble the battery pack. Never dispose of batteries in refuse containers. Always recycle batteries according to local regulations.



**NOTE** New batteries are approximately 30 percent charged. Therefore, connect the battery to AC power immediately after inserting a new a battery.

## Clean the monitor



**WARNING** Electric shock hazard. Before cleaning the device, disconnect the AC power cord from the power outlet and the device.



**WARNING** Electric shock hazard. DO NOT autoclave the device or accessories. The device and the accessories are not heat-resistant.



**WARNING** Electric shock hazard. Do not open the monitor or attempt repairs. Only perform routine cleaning and maintenance procedures specifically described in this manual. Inspection and servicing of internal parts shall only be performed by qualified service personnel.



**WARNING** Liquids can damage electronics inside the device. Prevent liquids from spilling on the device.

If liquids are spilled on the device:

- Power down the device.
- Disconnect the power plug.
- Remove battery pack from the device.
- Dry off excess liquid from the device.



**NOTE** If liquids possibly entered the device, remove the device from use until it has been properly dried, inspected, and tested by qualified service personnel.

- Reinstall battery pack.
- Power on the device and verify device functions normally before using it.

If liquids enter the printer housing (Connex VSM only):

- Power down the device.
- Disconnect the power plug.
- Remove battery pack from the device.
- Remove and discard the paper roll.
- Clean and dry the inside of the printer housing.



**NOTE** The printer housing has a drain tube that directs liquids down and out the bottom of the device. If liquids possibly entered other openings in the device, remove the device from service until it has been properly dried, inspected, and tested by qualified service personnel.

- Install a new roll of paper.
- Power on the device and verify that the device functions normally before using it.



**CAUTION** Sterilizing the monitor could damage the device.



**NOTE** Disinfect according to your facility's protocols and standards or local regulations.



**NOTE** See separate instructions for cleaning accessories.

## Prepare to clean the equipment



**CAUTION** Some cleaning agents are not compatible with all components of the device. Use only approved cleaning agents. Using unapproved cleaning agents may cause damage to components.



**CAUTION** Do not use bleach solutions of any kind when cleaning metal electrical contacts. They will damage the device.



**CAUTION** When cleaning the device, do not use incompatible cloths or solutions that include quaternary ammonium compounds (ammonium chlorides) or glutaraldehyde-based disinfectants.

Select an approved cleaning agent from the following table.

**Approved for the Connex Vital Signs Monitor and Connex Integrated Wall System main housings *except as noted in Additional information***

Cleaning agent	Additional information
Clorox HP Wipes	
Dispatch Hospital Cleaner Disinfectant Towels with Bleach (Clorox Healthcare®)	Not compatible with Braun dock
CleanCide Wipes (Wexford Labs)	
70 percent isopropyl alcohol solution	Applied to a clean cloth
10 percent bleach solution	(.5% - 1% sodium hypochlorite) applied to a clean cloth



**NOTE** To see the current list of cleaning agents that have been tested and identified as non-compatible and unapproved, see Customer Service Bulletin "CSM/CVSM Cleaning and Disinfection Compatibility," DIR 80023964.

## Clean the accessories

1. Wipe the NIBP hose and any reusable cuffs with a damp cloth moistened in a mild detergent solution.
2. Wipe the temperature probe with a cloth dampened with alcohol, warm water, or an appropriately diluted, nonstaining disinfectant solution.
3. Clean the pulse oximetry sensors with a cloth dampened with 70 percent isopropyl alcohol or 10 percent chlorine bleach solution.

4. Clean the RRa cable and the SpO2/RRa dual cable with a cloth dampened with 70 percent isopropyl alcohol.
5. Clean the EarlySense sensor by gently wiping with a soft, slightly damp cloth or wipes containing antiseptic substances (alcohols, Chlorohexidine, and bleach material up to 5% concentration). Ensure that the sensor is dry before re-use. Avoid excessive liquids.
6. To clean the ECG module, follow the instructions provided in the ECG module instructions for use.
7. (Connex IWS only) To clean Welch Allyn 3.5V instrument heads attached to the physical assessment handles, follow the instructions provided in their instructions for use.



**CAUTION** Never immerse any monitor accessories.

## Advanced settings

The Advanced tab provides password-protected access to the monitor's Advanced settings (or Admin mode), enabling nurse administrators, biomedical engineers, and/or service engineers to configure specific features. The Advanced tab also presents read-only information about the monitor.



**NOTE** You cannot enter Advanced settings if sensors or physiological alarms are active or if vital sign measurements are displayed.



**NOTE** If you lose your Advanced settings password, review the instructions to reset passwords in the service manual for your device.

Setup	Device	Clinician	Advanced
Advanced settings access			
<input type="button" value="Enter password"/>			
<input type="button" value="Lost password"/>			
<b>SN</b> 100001692510 Model VSM 6000 Series Asset tag AssetTag3		Hardware version P5 Software version 2.43.00 E0001 MAC address Ethernet 00:1A:FA:21:05:AF Radio 00:17:23:E3:02:D0 IP address Ethernet 0.0.0.0 Radio 172.18.26.131	
Configuration NIBP Pulse rate SpO2 Temperature SpHbv			
Home	Patients	Review	Settings

## General

### Specify the language

1. Access the Advanced settings.
  - a. Touch the **Settings** tab.
  - b. Touch the **Advanced** tab.
  - c. Touch **Enter password**.
  - d. Enter your password and touch **OK**.

The General tab appears, displaying the Language tab.

2. Select a language.
3. Do one of the following:

- To continue in the Advanced settings, touch another tab.
- To exit the Advanced settings and return to the Home tab, touch **Exit**.

## Specify date and time settings

1. Access the Advanced settings.
  - a. Touch the **Settings** tab.
  - b. Touch the **Advanced** tab.
  - c. Touch **Enter password**.
  - d. Enter your password and touch **OK**.

The General tab appears.
2. On the General tab, touch the **Date / Time** tab.
3. Specify settings.

### Setting

### Action/Description

Date format

Select a date format for display.

Time zone

Select your time zone offset from Coordinated Universal Time (UTC).

Automatically adjust clock for daylight saving time, reported by host

Select to adjust the displayed time by +/- one hour when the connected host reports daylight savings time.

Allow users to change date and time

Select to allow clinicians to set the date and time from the Settings tab.

Display date and time

Select to display the date and time on the Home tab in the Device Status area.

Enable NTP

Select to use the NTP server for time synchronization rather than the episodic host.

Host name or IP address

Enter the host name, IP address, or domain name of the NTP server.

Test

Touch **Test** to test the connection to the NTP server.

Information messages indicate that a test is in progress and then the result of the test (pass or fail).

4. Do one of the following:
  - To continue in the Advanced settings, touch another tab.
  - To exit the Advanced settings and return to the Home tab, touch **Exit**.

## Specify advanced alarm settings

1. Access the Advanced settings.
  - a. Touch the **Settings** tab.
  - b. Touch the **Advanced** tab.
  - c. Touch **Enter password**.
  - d. Enter your password and touch **OK**.

The General tab appears.
2. Touch the **Alarms** tab.
3. Specify settings.



Option	Description
<b>General</b>	(vertical tab)
Allow user to disable alarms	Select to allow clinicians to turn off or turn on all alarm limits for each vital sign. The control is on each parameter-specific tab on the Alarms tab.
Nurse call threshold	Select the minimum priority alarm that activates a nurse call relay. If you select <b>High</b> , only high-priority alarms activate a nurse call relay. If you select <b>Medium</b> , medium- or high- priority alarms activate a nurse call relay. If you select <b>Low</b> , high-, medium-, and low-priority alarms activate a nurse call relay.
<b>Audio</b>	(vertical tab)
Allow user to turn off general audio	Select to allow clinicians to turn off all audio notification for alarms. This control is on the Alarms tab (on the General tab).
Minimum alarm volume	Select the minimum alarm volume available. If you select <b>High</b> , then <b>Medium</b> and <b>Low</b> are not available to the clinician.
Audio pause time	Specify the amount of pause time that is added to the 60-second pause time. When a clinician pauses an audio alarm tone, the tone is paused for the combined amount of time.
Enable audio for low priority alarms	Select to enable the alarm to sound for low priority alarms. If this setting is disabled, the audio for very low priority alarms is automatically disabled.
Enable audio for very low priority alarms	Select to enable the alarm to sound for very low priority alarms. This setting is available only when "Enable audio for low priority alarms" is selected.
Allow user to turn on patient rest mode	Select to allow the user to turn off or turn on this option on the Alarms tab. This option is only available in the Continuous Monitoring profile and when the user has enabled night mode.
Allow host to turn on patient rest mode	Select to allow the host to turn off or turn on this option on the Alarms tab. This option is only available in the Continuous Monitoring profile and when the device is connected to the Central Station.
Enable cardiac high priority tone	Select to enable an alternate alarm tone for ECG LTA alarms.
<b>Delays</b>	(vertical tab)
SpO2 alarm condition delay	Specify the minimum amount of time that an SpO2 alarm condition must be active before audio and visual signals occur.
SpO2 pulse rate alarm condition delay	Specify the minimum amount of time that a Pulse rate alarm condition measured by the SpO2 sensor



**NOTE** Alarm delays are available only for the parameters supported by your configuration.

SatSeconds is available with Nellcor SpO2 sensors. If you select Off, 10-, 15-, or 30-second delay, SatSeconds is disabled, and it is removed from the SpO2 tab in the Alarms tab.

	must be active before audio and visual signals occur.
Motion pulse rate alarm condition delay	Specify the minimum amount of time that a Pulse rate alarm condition measured by the patient movement sensor must be active before audio and visual signals occur.
SpHb alarm condition delay	Specify the minimum amount of time that an SpHb alarm condition must be active before audio and visual signals occur.
Motion respiration alarm condition delay	Specify the minimum amount of time that a respiration alarm condition must be active before audio and visual signals occur (EarlySense configuration).
Motion pulse rate low confidence alarm delay	Specify the minimum amount of time that a pulse rate low confidence alarm condition must be active before audio and visual signals occur (EarlySense configuration).
Motion respiration low confidence alarm delay	Specify the minimum amount of time that a respiration low confidence alarm condition must be active before audio and visual signals occur (EarlySense configuration).
etCO2 alarm condition delay	Specify the minimum amount of time that an etCO2 alarm condition must be active before audio and visual signals occur.
Respiration alarm condition delay	Specify the minimum amount of time that an RR alarm condition must be active before audio and visual signals occur.
No breath detected alarm delay	<p>If configured with a CO2 module, specify the amount of time for the device to wait after receiving a "valid breath" message before activating the "No breath detected" physiological alarm.</p> <p>If configured for RRa, specify the time that the Masimo module will wait before sending a respiration pause event, which will result in a "No breath detected" physiological alarm.</p>
Adult no breath detected alarm delay	Specify the time that an adult no breath detected condition must be active in an Oridion CO2 configuration before audio and visual signals occur.
Pediatric no breath detected alarm delay	Specify the time that a pediatric no breath detected condition must be active in an Oridion CO2 configuration before audio and visual signals occur.
Neonate no breath detected alarm delay	Specify the time that a neonate no breath detected condition must be active in an Oridion CO2 configuration before audio and visual signals occur.
ECG HR alarm delay	Specifies the time that an ECG heart rate alarm condition must be active before audio and visual signals occur.

4. Do one of the following:
  - To continue in the Advanced settings, touch another tab.
  - To exit the Advanced settings and return to the Home tab, touch **Exit**.

## Specify advanced display settings

1. Access the Advanced settings.
  - a. Touch the **Settings** tab.

- b. Touch the **Advanced** tab.
- c. Touch **Enter password**.
- d. Enter your password and touch **OK**.

The General tab appears.

- 2. Touch the **Display** tab.
- 3. Specify settings.

**Setting**

Display power saver

Device power down

Display lock

Require device access code

Device access code

Require clinician authentication

Enable continue without login

**Action/Description**

Specify the required period of monitor inactivity before the display turns off.

Clinician interactions, new vital sign measurements, or alarm conditions automatically turn on the display.

Specify the required period of monitor inactivity before the monitor turns off.

Specify the required period of monitor inactivity before the touchscreen locks.



**NOTE** If the single sign-on (SSO) feature has been enabled on this device, the display lock idle period defaults to 2 minutes but remains configurable. In addition, all of the remaining controls described in this section (except for Enable continue without login) disappear from the display, but the Require clinician authentication control remains active as part of the SSO feature.

Enable to require entering a code to unlock the display.

Enter the 4-digit code to unlock the display.



**NOTE** You must enable Require device access code to enable this option.

Enable to require clinician authentication (scanning badge or entering ID) to unlock the display.



**NOTE** You must enable Search by clinician ID to enable this option.

Select to enable "Continue without login" button on the authentication dialog to unlock the display.



**NOTE** You must enable either Enable single sign-on or Search by clinician ID, and enable Require clinician ID match to view patient data to enable Patient Protection mode which is required with this option.



**NOTE** Additionally, If the Search by clinician ID feature has been enabled on this device, you must enable Require clinician authentication to enable the configuration of Enable continue without login.

4. Do one of the following:
  - To continue in the Advanced settings, touch another tab.
  - To exit the Advanced settings and return to the Home tab, touch **Exit**.

## Specify advanced device settings

1. Access the Advanced settings.
  - a. Touch the **Settings** tab.
  - b. Touch the **Advanced** tab.
  - c. Touch **Enter password**.
  - d. Enter your password and touch **OK**.

The General tab appears.

2. Touch the **Device** tab.
3. Specify settings.

### Option

Location ID

Enable Save as default

Pause Mode timeout

Power line frequency

Available profiles

Allow profile change

### Description

Touch  and enter up to 20 alphanumeric characters.

Select to enable display of the Save as default control.

Specify the default timeout used when entering Pause mode in the Continuous Monitoring profile.

Specify power line frequency for AC power supplied to the device.

Specify the profiles to be available for selection.

Select to enable manual selection of different profiles and the automatic shift to the Continuous Monitoring profile when a continuous sensor is connected to a patient.

When disabled, the current profile selection in the Settings tab is locked in. No other profile selection buttons are available, and the device does not automatically shift to the Continuous Monitoring profile when a continuous sensor is connected to a patient.

Default profile

Specify the default profile to be used at startup.

4. Do one of the following:
  - To continue in the Advanced settings, touch another tab.
  - To exit the Advanced settings and return to the Home tab, touch **Exit**.

## Set and start the demo mode

1. Access the Advanced settings.
  - a. Touch the **Settings** tab.
  - b. Touch the **Advanced** tab.
  - c. Touch **Enter password**.
  - d. Enter your password and touch **OK**.

The General tab appears.

2. Touch the **General** tab.
3. Touch the **Demo** tab.
4. Specify settings.

### Setting

Type

Start

### Action/Description

Select a type of demonstration mode.

Touch **Start** to put the monitor in demonstration mode. Navigate to the Home tab to begin Demo mode.

5. Do one of the following:
  - To continue in the Advanced settings, touch another tab.
  - To exit the Advanced settings and return to the Home tab, touch **Exit**.

## Parameters

### Specify advanced IPI settings

1. Access the Advanced settings.
  - a. Touch the **Settings** tab.
  - b. Touch the **Advanced** tab.
  - c. Touch **Enter password**.
  - d. Enter your password and touch **OK**.

The General tab appears.

2. Touch the **Parameters** tab.
3. Touch the **IPI** tab.
4. Specify settings.

### Setting

Display IPI

Default view

Trend period default

### Action/Description

Select to display the IPI frame on the Home tab.

Select a numeric view or trend graph view as the primary IPI display on the Home tab.

Select a default time period for the trend graph display of IPI.

5. Do one of the following:
  - To continue in the Advanced settings, touch another tab.
  - To exit the Advanced settings and return to the Home tab, touch **Exit**.

## Specify advanced RRa settings

1. Access the Advanced settings.
  - a. Touch the **Settings** tab.
  - b. Touch the **Advanced** tab.
  - c. Touch **Enter password**.
  - d. Enter your password and touch **OK**.

The General tab appears.

2. Touch the **Parameters** tab.
3. Touch the **RRa** tab.
4. Specify settings.

### Setting

RRa averaging

Freshness timeout

### Action/Description

Select the default averaging option that provides the desired visibility of subtle variations in RRa measurements.

Select the period of time the device should wait before alarming while it attempts to obtain a valid RRa reading.

5. Do one of the following:
  - To continue in the Advanced settings, touch another tab.
  - To exit the Advanced settings and return to the Home tab, touch **Exit**.

## Specify advanced SpO2 settings

1. Access the Advanced settings.
  - a. Touch the **Settings** tab.
  - b. Touch the **Advanced** tab.
  - c. Touch **Enter password**.
  - d. Enter your password and touch **OK**.

The General tab appears.

2. Touch the **Parameters** tab.
3. Touch the **SpO2** tab.
4. Specify settings.

### Setting

Default view

Default response

Sweep speed default

Allow low perfusion alarm

### Action/Description

Select a numeric view or a waveform view as the default primary SpO2 display on the Home tab.

Select the default speed of response to changes in SpO2 measurements.

Select the default waveform sweep speed for the SpO2 display in the Home tab.

Select to enable Masimo low perfusion alarm.

5. Do one of the following:

- To continue in the Advanced settings, touch another tab.
- To exit the Advanced settings and return to the Home tab, touch **Exit**.

## Specify advanced HR/PR (pulse rate) settings

1. Access the Advanced settings.
  - a. Touch the **Settings** tab.
  - b. Touch the **Advanced** tab.
  - c. Touch **Enter password**.
  - d. Enter your password and touch **OK**.

The General tab appears.

2. Touch the **Parameters** tab.
3. Touch the **HR/PR** (Pulse rate) tab.
4. Specify settings.

### Setting

Display source

### Action/Description

Select this to show the source of pulse rate measurements (NIBP or SpO2) on the Home tab.

5. Do one of the following:
  - To continue in the Advanced settings, touch another tab.
  - To exit the Advanced settings and return to the Home tab, touch **Exit**.

## Specify advanced etCO2 settings

1. Access the Advanced settings.
  - a. Touch the **Settings** tab.
  - b. Touch the **Advanced** tab.
  - c. Touch **Enter password**.
  - d. Enter your password and touch **OK**.

The General tab appears.

2. Touch the **Parameters** tab.
3. Touch the **etCO2** tab.
4. Specify settings.

### Setting

Default view

Display FiCO2

Waveform scale default

Unit of measure

Check calibration

Calibrate

Sweep speed default

### Action/Description

Select a numeric view or a waveform view as the primary etCO2 display on the Home tab.

Select to display FiCO2 on the Home tab.

Select the default waveform scale in etCO2 measurements.

Select primary units of measure for the etCO2 display on the Home tab.

Select to start CO2 calibration check.

Select to start CO2 calibration.

Select the default waveform sweep speed for the CO2 waveform view on the Home tab.

Enable sampling line dialog	Select to enable the sampling line dialog to be displayed when connecting a sampling line to the device.
BTPS compensation	Select to enable automatic adjustments for BTPS (body temperature pressure saturated) to improve the accuracy of CO2 measurements.
Calibration due hours	Displays time remaining until CO2 sensor calibration is required.
Maintenance due hours	Displays time remaining until CO2 periodic sensor maintenance is required.
Last calibration	Displays date (XX/XX/XXXX) and time (00:00:00) of last calibration.
Annual calibration	Displays anniversary date (XX/XX) of annual calibration.
<ul style="list-style-type: none"> <li>• For more calibration information, see the Service manual.</li> </ul>	
5. Do one of the following:	
<ul style="list-style-type: none"> <li>• To continue in the Advanced settings, touch another tab.</li> <li>• To exit the Advanced settings and return to the Home tab, touch <b>Exit</b>.</li> </ul>	

## Specify advanced SpHb settings

1. Access the Advanced settings.
  - a. Touch the **Settings** tab.
  - b. Touch the **Advanced** tab.
  - c. Touch **Enter password**.
  - d. Enter your password and touch **OK**.

The General tab appears.

2. Touch the **Parameters** tab.
3. Touch the **SpHb** tab.
4. Specify settings.

### Setting

Default view

Unit of measure

Default averaging

Reference

### Action/Description

Select a numeric view or a trend graph view as the primary SpHb display on the Home tab.

Select the primary unit of measure for the SpHb display on the Home tab.

Select the default moving window of time used by the parameter to calculate the SpHb value and update the display: short (approximately 1 minute), medium (approximately 3 minutes), or long (approximately 6 minutes).

Select arterial or venous as the calibrated reference source.

5. Do one of the following:
  - To continue in the Advanced settings, touch another tab.
  - To exit the Advanced settings and return to the Home tab, touch **Exit**.

## Specify advanced NIBP settings

1. Access the Advanced settings.



- a. Touch the **Settings** tab.
- b. Touch the **Advanced** tab.
- c. Touch **Enter password**.
- d. Enter your password and touch **OK**.

The General tab appears.

2. Touch the **Parameters** tab.
3. Touch the **NIBP** tab.
4. Specify settings.

#### Setting

Default view

#### Action/Description

Select primary and secondary views.

Select **Display MAP** to display mean arterial pressure (MAP) in the NIBP frame on the Home tab.

If **Display MAP** is selected, specify which numerics are primary in the NIBP frame. On the Home tab, clinicians can touch the NIBP frame to toggle between views.

Unit of measure

Select the NIBP unit of measure for display.

Tube type

Select the number of tubes that are connected to the NIBP cuff used with this monitor. If you select **1 tube**, the only algorithm available for selection is **Step**.

Algorithm default

Select the default algorithm used to determine NIBP measurements.

Cuff inflation target

If you select the **Step** algorithm, touch  and enter a default cuff inflation target for each type of patient. Clinicians can change the CITs from the default CITs that you set here on the **Settings > Setup > NIBP** tab.

Allow interval program changes

Select to enable user to modify interval program selections in the **Settings > Setup > Intervals** tab.

5. Do one of the following:
  - To continue in the Advanced settings, touch another tab.
  - To exit the Advanced settings and return to the Home tab, touch **Exit**.

## Set up an NIBP averaging program

In Advanced settings, set up NIBP averaging programs to make them available for use.

To set up a program:

1. Access the Advanced settings.
  - a. Touch the **Settings** tab.
  - b. Touch the **Advanced** tab.
  - c. Touch **Enter password**.
  - d. Enter your password and touch **OK**.

The General tab appears.

2. Touch the **Parameters** tab.

3. Touch the **Programs** tab.
4. Touch the button of the program you want to set up.

The keyboard icon appears in the button.

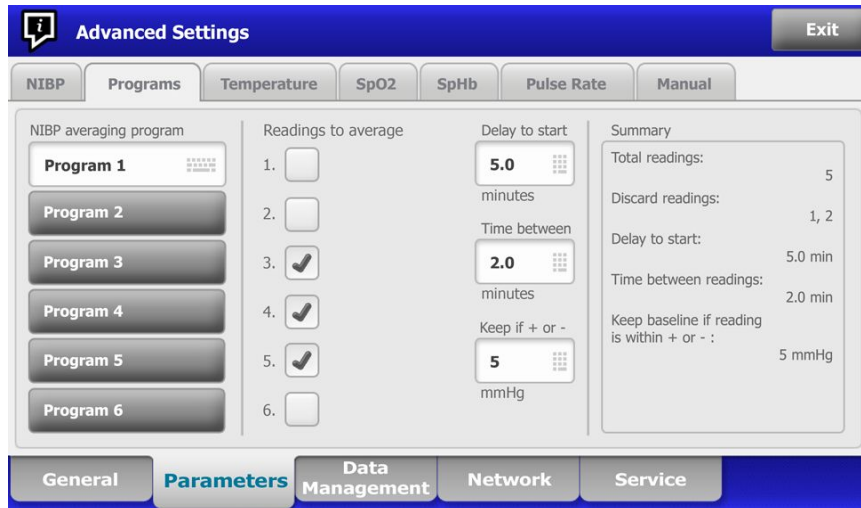

5. (Optional) Change the name of the program:
  - a. Touch the keyboard icon.
  - b. Enter the name of the program and touch **OK**.
6. Specify the settings for this program.

#### Setting

Readings to average

Delay to start

Time between

Keep if + or -

#### Action/Description

Select readings to include in the average. You must select at least two readings.

The last reading you select is the final reading of the program. For example, if you select Readings 3, 4, and 5, the program takes five readings.

Unselected readings—in this example, Readings 1 and 2—are excluded ("discarded") from the average.

Enter the period between the start of the program (the moment that the "Start intervals" button is selected) and the start of the first reading.

Enter the period between the end of one reading and the start of the next reading.

Enter the range that the program uses to establish the baseline reading. For more information about how this setting affects the program, refer to "Excluded readings" in the "NIBP averaging programs" section of this manual.

The settings you selected appear in the Summary area.

7. Do one of the following:
  - To continue in the Advanced settings, touch another tab.
  - To exit the Advanced settings and return to the Home tab, touch **Exit**.

The program is now available for use.

## Specify advanced temperature settings

1. Access the Advanced settings.
  - a. Touch the **Settings** tab.
  - b. Touch the **Advanced** tab.
  - c. Touch **Enter password**.
  - d. Enter your password and touch **OK**.

The General tab appears.

2. Touch the **Parameters** tab.
3. Touch the **Temperature** tab.
4. Specify settings.

### Setting

Unit of measure

Display temperature conversion

Default SureTemp Plus site

Anti-theft return timeout

Mode

Enable pulse timer

Enable Celsius only selection

### Action/Description

Select primary units of measure for the temperature display on the Home tab

Select to display primary units of measure and secondary units of measure for the temperature display on the Home tab.

Select the default site for SureTemp measurements. The default site applies when clinicians power up the monitor and each time clinicians remove the temperature probe from the well.

Select **Last site** to set the default to the site selected for the last measurement.

Select "Disabled" or a timeout value in hours for the Braun 6000 to lock after being removed from the dock.

Select **None**, **Technique Compensation**, or **Unadjusted** as the Braun 6000 compensation mode. Technique Compensation improves reading accuracy by detecting placement of the probe in the ear canal. Unadjusted places thermometer in mode to detect raw ear temperature only.

Select to enable pulse timer on the Braun 6000 handle.

Select to enable Celsius only mode, thus disabling the C/F button on the Braun 6000 handle as well as the hardware switch.

5. Do one of the following:
  - To continue in the Advanced settings, touch another tab.
  - To exit the Advanced settings and return to the Home tab, touch **Exit**.

## Specify advanced ECG settings

1. Access the Advanced settings.
  - a. Touch the **Settings** tab.
  - b. Touch the **Advanced** tab.
  - c. Touch **Enter password**.
  - d. Enter your password and touch **OK**.

- The General tab appears.
2. Touch the **Parameters** tab.
  3. Touch the **ECG** tab.
  4. Specify settings.

#### Setting

Cable selection

Electrode configuration

Allow impedance respiration

Enable V-Tach, V-Fib, Asystole detection

Automatic print on ECG alarm

Default lead

V-Tach threshold

5. Do one of the following:
  - To continue in the Advanced settings, touch another tab.
  - To exit the Advanced settings and return to the Home tab, touch **Exit**.

#### Action/Description

Select either a 3-lead or 5-lead cable option. The current selection appears as a secondary label on the ECG vertical tab.

Select either **AHA** or **IEC**.

Select to enable the selection of impedance respiration as a source for respiration on the ECG settings tab. If not selected, this option is disabled, and impedance respiration is not displayed as an option on the ECG settings tab.

Select to enable detection of these LTA alarms.

Select to enable automatic printing of an ECG waveform when an LTA alarm occurs.

Select the lead to be displayed when the device is powered up.

Use the keypad to enter the V-Tach threshold used by the ECG module (Range: 100-150 bpm).

## Specify the manual parameters

The Manual Parameters frame is in the lower right corner of the Home tab. You can manually enter values for parameters in the frame. In Advanced settings, you can specify which parameters appear in the frame and enable manual overrides of other parameter measurements displayed on the device.

1. Access the Advanced settings.
  - a. Touch the **Settings** tab.
  - b. Touch the **Advanced** tab.
  - c. Touch **Enter password**.
  - d. Enter your password and touch **OK**.

The General tab appears.

2. Touch the **Parameters** tab.
3. Touch the **Manual** tab.

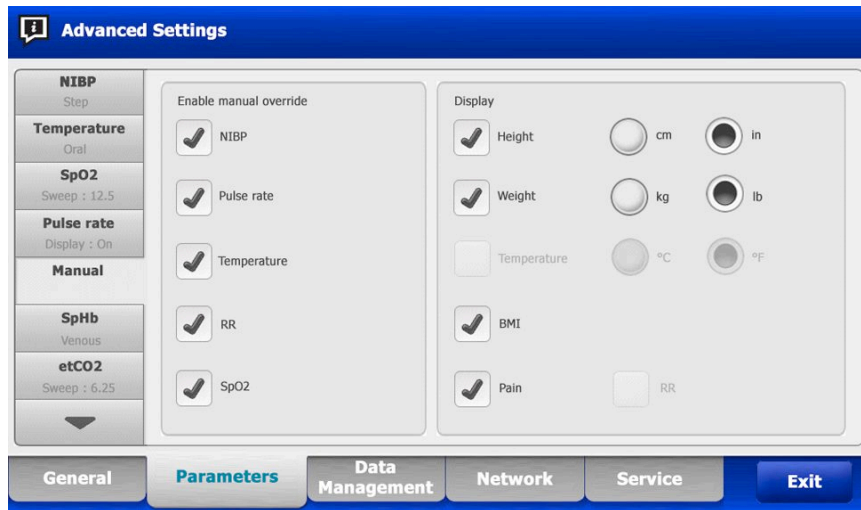

4. Select up to four parameters and associated units of measure for display in the Manual Parameters frame.



**NOTE** If the monitor has the SureTemp Plus temperature module, the Temperature parameter is not available in the Display frame or in the Manual Parameters frame on the Home tab.



**NOTE** If the monitor is configured with CO<sub>2</sub> or RRA, and you select the Continuous Monitoring profile before you enter Advanced settings, the respiration rate (RR) parameter is not available here or in the Manual Parameters frame. If any other profile is selected when you enter Advanced settings, the respiration rate (RR) parameter remains available for selection on this screen and is displayable in the Manual parameters frame.

5. Enable manual overrides of selected parameter measurements displayed on the device as desired.
6. Do one of the following:
  - To continue in the Advanced settings, touch another tab.
  - To exit the Advanced settings and return to the Home tab, touch **Exit**.

## Specify advanced custom scores settings

1. Access the Advanced settings.
  - a. Touch the **Settings** tab.
  - b. Touch the **Advanced** tab.
  - c. Touch **Enter password**.
  - d. Enter your password and touch **OK**.

The General tab appears.
2. Touch the **Parameters** tab.
3. Touch the **Custom scores** tab.
4. Specify settings.

**Setting**

Default score summary view

Incomplete score save options

**Action/Description**

Select either a **Condensed** or **Expanded** view of custom scores information to display after saving a patient record.

Select the desired response when a user presses Save before an aggregate score is complete:

**Allow:** The device saves the record with incomplete scores.

**Warn user:** The device displays a message that the score is incomplete and a prompt to save the incomplete record or cancel.

**Block:** The device displays a message that the score is incomplete and that values for all required parameters must be entered before saving.

5. Do one of the following:
  - To continue in the Advanced settings, touch another tab.
  - To exit the Advanced settings and return to the Home tab, touch **Exit**.

## Data management

### Specify patient settings

Patient identification appears on the Home tab in the Patient frame, and it is listed in various tabs, such as the Patient tab and the Review tab.

1. Access the Advanced settings.
  - a. Touch the **Settings** tab.
  - b. Touch the **Advanced** tab.
  - c. Touch **Enter password**.
  - d. Enter your password and touch **OK**.

The General tab appears.

2. Touch the **Data Management** tab.
3. Touch the **Patient** tab.
4. Specify settings.

**Setting**

Default patient type

Enable local patient creation

**Action/Description**

Select a default patient type for this monitor. The patient type shows in the Patient frame on the Home tab.

In the Summary tab on the Patients tab, clinicians can change the displayed patient type from the default patient type that you set here.

Select to enable adding new patients on the device. If enabled, you can add patients to the Patient List tab or to the Patient Summary tab.

If disabled, the Add button does not appear on the List screen, and you can only edit the Patient ID field on the Summary tab. Disabling local patient creation also clears the active patient and the local patient list from the device.

Name format	Select a format for all displayed patient names: <b>Full name</b> or <b>Abbreviation</b> .
Primary label	Select the primary identification label for all displayed patients.
Secondary label	Select a secondary identification label for patients. A secondary label displays only on the Home tab, after the primary label.
Printout label	Select which patient identifier(s) appear on printouts: <b>Name and patient ID, Name, Patient ID, None</b> .
Require patient ID to save readings	Make entering a patient ID a prerequisite for saving measurements. If the clinician fails to enter an identifier, the monitor prompts the clinician when they try to save.
Search by patient ID	<p>Enable clinicians to enter a patient ID to query for the patient's information. If clinicians scan the ID onto the Home tab or the Summary tab, the monitor queries the patient list and the network. Returned patient information populates the Patient frame on the Home tab and fields on the Summary tab.</p> <p>Select <b>Require patient ID match to save measurements</b> to require that the selected patient ID matches a patient ID in the Patient list of the device or an external host system before you can save measurements.</p>
Clear patient information on manual save	Specify that the monitor clears the selected patient after a clinician manually saves measurements from the Home tab. Patient information clears from the Patient frame and the Summary tab.
	<p> <b>NOTE</b> This setting does not take effect when intervals are in progress.</p>
Retrieve list	<p>Enable the monitor to retrieve the patient list from the network. When this option is selected, a <b>Retrieve list</b> button replaces the <b>Add</b> button on the List tab. Information from the network populates the List tab when clinicians touch the <b>Retrieve list</b> button. Since the <b>Add</b> button is not available, clinicians cannot add a patient to the patient list.</p> <p>Direct EMR connection is not compatible with the Retrieve list setting. Retrieve list is disabled and not selectable when you enable Direct EMR connection.</p> <p>Configuring the server back to Welch Allyn host restores the Retrieve list setting to its previous state and makes it selectable.</p>

5. Do one of the following:
  - To continue in the Advanced settings, touch another tab.
  - To exit the Advanced settings and return to the Home tab, touch **Exit**.

## Specify clinician settings

Clinician identification appears next to the medicine symbol in the Device Status area on the Home tab.

1. Access the Advanced settings.
  - a. Touch the **Settings** tab.
  - b. Touch the **Advanced** tab.
  - c. Touch **Enter password**.
  - d. Enter your password and touch **OK**.

The General tab appears.

2. Touch the **Data Management** tab.
3. Touch the **Clinician** tab.
4. Specify settings.

### Setting

Label

Enable single sign-on

Require clinician ID to save readings

Clear clinician information on manual save

Require clinician ID match to view patient data

### Action/Description

Select a type of clinician identification label for display on the Home tab: **Full name**, **Abbreviation**, **Clinician ID**, **Masked Clinician ID**, or **Symbol only**.

Select to enable the single sign-on (SSO) feature on the device.



**NOTE** When SSO is enabled, many of the remaining controls described in this section are removed from the display. However, Clear clinician information on manual save and Require clinician ID match to view patient data remain configurable when Enable single sign-on is enabled. In addition, Display lock defaults to 2 minutes, three Display tab controls disappear from the display (see "Specify advanced display settings" for details), and the Office profile is disabled.

Make entering a clinician ID a prerequisite for saving measurements. If they fail to enter identification, the monitor prompts them when they try to save measurements. Clinicians can enter clinician identification on the Clinician tab.

Specify that the monitor clears the selected clinician after a clinician manually saves measurements from the Home tab. Clinician information clears from the Clinician tab and the Device Status area.

Select to enable Patient Protection mode, which prevents viewing the Patients List and Review tabs or changing profiles without an authenticated clinician being logged in.



Search by clinician ID

Enable the monitor to query the network for clinician information based on ID. The monitor initiates the search when the clinician enters or scans the ID from the Clinician tab. Returned clinician information populates the Device Status area and fields on the Clinician tab.

Select **Require password** to require clinicians to enter their password, in addition to ID, on the Clinician tab. The monitor uses the ID and password combination to query the network for clinician information.

Select **Require clinician ID match to save measurements** to require that the selected clinician ID matches a clinician ID in an external host system before you can save measurements.

Store clinician information for \_\_\_\_ hours

Select to enable a local cache of clinician login information to speed up and simplify future clinician logins. Use the keypad to enter the number of hours to store this clinician cache.

5. Do one of the following:
  - To continue in the Advanced settings, touch another tab.
  - To exit the Advanced settings and return to the Home tab, touch **Exit**.

## Specify clinical data settings

1. Access the Advanced settings.
  - a. Touch the **Settings** tab.
  - b. Touch the **Advanced** tab.
  - c. Touch **Enter password**.
  - d. Enter your password and touch **OK**.

The General tab appears.

2. Touch the **Data Management** tab.
3. Touch the **Clinical Data** tab.
4. Specify settings.

### Setting

Automatically send on manual save

### Action/Description

Select this option to specify that measurements are sent to the network when a clinician saves measurements on the Home tab.



**NOTE** When the device is in the Continuous Monitoring profile, this setting is grayed out.



**NOTE** When the monitor is not connected to the network, measurements saved on the monitor are sent to the network with the first successful send after reconnecting to the network.

Delete readings after successful send

Select this option to specify that measurements are deleted from the monitor after they are successfully

Emulate Spot Vital Signs LXi	sent to the network. Sent measurements do not appear in the Review tab.
Connect to CS	<p>Select this option to specify that clinical data sent to the network appears as Spot Vital Signs LXi data at the network.</p> <p>Select to enable connection to the Connex central station.</p> <p>Direct EMR connection is not compatible with the Connect to CS setting. Connect to CS is disabled and not selectable when you enable Direct EMR connection.</p> <p>Configuring the server back to Welch Allyn host restores the Connect to CS setting to its previous state and makes it selectable.</p>
Enable clear button on Home tab	Select to enable the Clear button on the Home tab in Intervals Monitoring, Office, and Spot Check profiles. When not selected (disabled), the Clear button does not appear on the Home tab.

5. Do one of the following:

- To continue in the Advanced settings, touch another tab.
- To exit the Advanced settings and return to the Home tab, touch **Exit**.

## Network

### View advanced monitor information

The Status tab shows the monitor's software version, MAC and IP addresses, network, server and access point information, session information, and more.

1. Access the Advanced settings.
  - a. Touch the **Settings** tab.
  - b. Touch the **Advanced** tab.
  - c. Touch **Enter password**.
  - d. Enter your password and touch **OK**.

The General tab appears.
2. Touch the **Network** tab.
3. Touch the **Status** tab.
4. View the information.
5. Do one of the following:
  - To continue in the Advanced settings, touch another tab.
  - To exit the Advanced settings and return to the Home tab, touch **Exit**.

### Specify radio settings (Newmar)

This task applies only to devices with a Newmar radio card installed. Distinguishing features of devices with this radio card are the following:

- In Advanced settings, the Session frame on the **Network > Status** tab includes **Tx packets dropped**, **Rx packets dropped**, and **Rx multicast packets**.

- In Advanced settings, the left pane on the **Network > Radio** tab includes an *Enable dynamic frequency* option.
1. Access the Advanced settings.
    - a. Touch the **Settings** tab.
    - b. Touch the **Advanced** tab.
    - c. Touch **Enter password**.
    - d. Enter your password and touch **OK**.

The General tab appears.

2. Touch the **Network** tab.
3. Touch the **Radio** tab.
4. Specify settings.

**Setting**

Enable radio

Enable radio network alarms

Enable dynamic frequency

SSID

Radio band

Authentication type

Method

Security protocol

EAP type

Identity

Password

Key number

Key

Roam Type

**Action/Description**

Enable the radio for device communications. When disabled, the radio is not available.

Activate radio network alarms when an alarm condition occurs. When disabled, radio network alarms are not available.

Enable dynamic frequency selection when the radio is enabled. This might be required to prevent disrupting other technologies and services that share the same frequency.

Touch  and enter the service set identifier (SSID). SSIDs that are longer than 16 characters may be truncated in the user view. Enter a maximum of 32 characters.

Select the radio band.

Select an authentication scheme. Then specify any additional settings that appear.

Select a method. Then touch  and enter characters: Network key (64 characters), or Passphrase (8 to 63 characters).



**NOTE** The characters you enter for Network key and Passphrase appear as asterisks on the keyboard and then on the Radio pane.

Select the security protocol.

Select the EAP type.

Enter the EAP identity (maximum of 32 characters).

Enter the EAP password (maximum of 32 characters).

Select the WEP key number.

Enter the WEP key (10 characters for WEP 64, or 26 characters for WEP 128).

Select roam type.

Server validation	Select to enable server validation.
Inner EAP setting	Select inner EAP setting.
Allow anonymous identity	Select to enable the use of an anonymous identity.
PAC Provisioning	Select PAC provisioning option.
Configure radio	Touch <b>Configure radio</b> to activate all new radio settings not selected previously.



**NOTE** None of the changed radio settings take effect until you touch **Configure radio**.

- Do one of the following:
  - To continue in the Advanced settings, touch another tab.
  - To exit the Advanced settings and return to the Home tab, touch **Exit**.

## Specify radio settings (Lamarr)

This task applies only to devices with a Lamarr radio card installed. Distinguishing features of devices with this radio card are the following:

- In Advanced settings, the Session frame on the **Network > Status** tab includes **Dir. Rx packets**, **Dir. Tx packets**, and **Signal-to-noise ratio**.
- In Advanced settings, the left pane on the **Network > Radio** tab includes only *Enable radio* and *Enable radio network alarms* options (no *Enable dynamic frequency* option).

- Access the Advanced settings.
  - Touch the **Settings** tab.
  - Touch the **Advanced** tab.
  - Touch **Enter password**.
  - Enter your password and touch **OK**.

The General tab appears.

- Touch the **Network** tab.
- Touch the **Radio** tab.
- Specify settings.

### Setting

Enable radio

Enable radio network alarms

SSID

Radio band

Authentication type

### Action/Description

Enable the radio for device communications. When disabled, the radio is not available.



Activate radio network alarms when an alarm condition occurs. When disabled, radio network alarms are not available.



Touch  and enter the service set identifier (SSID). SSIDs that are longer than 16 characters may be truncated in the user view. Enter a maximum of 32 characters.

Select the radio band.

Select an authentication scheme. Then specify any additional settings that appear.

Method	Select a method. Then touch  and enter characters: Network key (64 characters), or Passphrase (8 to 63 characters).
	 <p><b>NOTE</b> The characters you enter for Network key and Passphrase appear as asterisks on the keyboard and then on the Radio pane.</p>
Security protocol	Select the security protocol.
EAP type	Select the EAP type.
Identity	Enter the EAP identity (maximum of 32 characters).
Password	Enter the EAP password (maximum of 32 characters).
Key number	Select the WEP key number.
Key	Enter the WEP key (10 characters for WEP 64, or 26 characters for WEP 128).
Configure radio	<p>Touch <b>Configure radio</b> to activate all new radio settings not selected previously.</p> <p>Touch <b>OK</b> in the confirmation popup telling you to power down the monitor.</p> <p>Touch the <b>Settings</b> tab. Touch the <b>Device</b> tab. Touch <b>Power down</b>.</p> <p>The radio will reboot.</p>
	 <p><b>NOTE</b> None of the changed radio settings take effect until you touch <b>Configure radio</b>.</p>

5. Do one of the following:
  - To continue in the Advanced settings, touch another tab.
  - To exit the Advanced settings and return to the Home tab, touch **Exit**.

## Specify server settings

1. Access the Advanced settings.
  - a. Touch the **Settings** tab.
  - b. Touch the **Advanced** tab.
  - c. Touch **Enter password**.
  - d. Enter your password and touch **OK**.

The General tab appears.
2. Touch the **Network** tab.
3. Touch the **Server** tab.
4. Select the method used to identify the IP address of the server with which the device will communicate.
5. Specify settings.

## Connectivity Setting

Manual entry

## Action/Description

Enable the device to connect to a Episodic, Continuous, or Service server at a fixed IP address or with a specified DNS name. Touch the desired server field and enter the IP address host name. Touch the Port entry field and enter the port number. The range of entry is 0 to 65535.

This option supports server Authentication to either the Welch Allyn host (NCE and Connex CS) or a Direct EMR connection using HL-7. Touch the Server dropdown menu to select the server type. The Authentication option is disabled by default and only applies to the Episodic server. Authentication is not available when Data encryption is disabled.

Direct EMR connection is not compatible with Connect to CS or Retrieve list settings. Both settings are disabled and not selectable when you enable Direct EMR connection.

Configuring the server back to Welch Allyn host restores the Connect to CS and Retrieve list settings to their previous states and makes them selectable.

NRS IP

Enable the device to connect to a Network Rendezvous Service (NRS) at a fixed IP address. Touch the keypad in the Network rendezvous service IP address fields and enter the IP address. Touch the keypad in the Port entry field and enter the port number. The range of entry is 0 to 65535. The device will always use this IP address to contact the NRS server.

DNS Name

Enable the device to connect to a Network Rendezvous Service (NRS) by entering a host name to be sent to a Domain Name Server (DNS) to retrieve the NRS IP address. Touch the keypad in the Network rendezvous service DNS name field and enter the DNS name. Touch the keypad in the Port entry field and enter the port number. The range of entry is 0 to 65535.

The device displays the NRS IP address as well as the Connex server address and port returned by the DNS.

Enable data encryption for Episodic, Continuous, or Service server

The DNS Name option is only available in the following conditions:

- The radio is disabled
- No radio is installed

DHCP

Enable the device to connect to a Network Rendezvous Service (NRS) by entering a port number and then connecting at an address provided by the DHCP43 response. Touch the keypad in the Port entry field and enter the port number. The range of entry is 0 to 65535.

After you touch **Test** and successfully connect to the server, the device displays the NRS IP addresses.

Data encryption	Enable data encryption for Episodic, Continuous, or Service server and for the following Connectivity types: Manual entry, NRS IP, DNS Name, and DHCP
Authentication	Enable authentication with Episodic or Continuous server. This option is disabled by default and is only available when Data encryption is enabled and for manual entry Connectivity.
Restore defaults	Touch <b>Restore defaults</b> to restore settings for the selected option to the default values.
Test	Touch <b>Test</b> to test the connection to the configured server.

- Do one of the following:
  - To continue in the Advanced settings, touch another tab.
  - To exit the Advanced settings and return to the Home tab, touch **Exit**.

## Specify Active Directory settings

- Access the Advanced settings.
  - Touch the **Settings** tab.
  - Touch the **Advanced** tab.
  - Touch **Enter password**.
  - Enter your password and touch **OK**.

The General tab appears.

- Touch the **Network** tab.
- Touch the **Active Directory** tab.
- Specify settings.

### Setting

Enable Active Directory

### Action/Description

Select this option as the first step to connect to an Active Directory server (an alternative way to perform clinician queries).

When you enable this control, you enable all other controls on this tab.

Host or IP address

Touch the keypad in the Host or IP address field and enter the Host name (Fully Qualified Domain Name) or IP address of the Active Directory server. This is an alpha-numeric string with a maximum length of 121 characters.

Group

Touch the keypad in the Group field and enter the Domain Group address. This is an alpha-numeric string with a maximum length of 121 characters.

Clinician ID type

Touch the Clinician ID type dropdown menu to select the Clinician identifier.

This selection has no effect on the appearance of Clinician information on the display. It only affects communication of the request to the Active Directory server.

Authentication user name

Touch the keypad in the Authentication user name field and enter the User name. This is an alpha-numeric string with a maximum length of 100 characters.

Authentication password	Touch the keypad in the Authentication password field and enter the User password. This is an alpha-numeric string with a maximum length of 20 characters.
Search subtree	Touch the keypad in the Search subtree field and enter what you want to search in the Active Directory. This is an alpha-numeric string with a maximum length of 121 characters.
Test	Touch <b>Test</b> to test the connection to the Active Directory server.  Information messages indicate that a test is in progress and then the result of the test (pass or fail).

5. Do one of the following:
  - To continue in the Advanced settings, touch another tab.
  - To exit the Advanced settings and return to the Home tab, touch **Exit**.

## Service

The Service tab presents numerous settings and controls typically accessed by authorized service or biomedical engineering personnel to configure, maintain, test, and update the device. For example, the Service tab enables authorized users to save device configurations to a USB flash drive and then load saved configurations to other devices. Systems and devices configured with the PartnerConnect™ service feature also have access to remote diagnostics, troubleshooting, and software upgrades.

For a description of service-related advanced settings, see the service manual for this product.



## Troubleshooting

This section presents tables of technical alarm and information messages, as well as problem descriptions that do not generate messages, to help you troubleshoot issues on the monitor.



**NOTE** Problem descriptions without messages appear at the end of this section.

When the monitor detects certain events, a message appears in the Device Status area at the top of the screen. Message types include the following:

- Information messages, which appear on a blue background.
- Very low-priority alarms, which appear on a cyan background.
- Low- and medium-priority alarms, which appear on an amber background.
- High-priority alarms, which appear on a red background.

Technical alarm messages are low or very low priority unless noted in the Message column.

You can dismiss a message by touching the message on the screen, or, for some messages, you can wait for the message to time out.

To use these tables, locate the message that displays on the monitor in the left column of the table. The remainder of the row explains possible causes and suggests actions that can resolve the issue.



**NOTE** Instructions to "Call for service" in the following tables mean that you should contact qualified service personnel in your facility to investigate the issue.

## Patient movement messages

Message	Possible cause	Suggested action
Replace the bed sensor.	The sensor is faulty or expired	Replace the bed sensor.
	The cable is faulty or expired	Replace the cable.
The bed sensor is disconnected.	The bed sensor is disconnected from the monitor	Check the bed sensor cable to ensure that connections to the monitor and the extension cable are tight.
	The bed sensor is disconnected from the extension cable	
The bed sensor is upside down.	The bed sensor was not placed properly under the mattress, mattress cover, or mattress pad	Turn the sensor right-side up.

<b>Message</b>	<b>Possible cause</b>	<b>Suggested action</b>
Cannot measure patient. Lost or unstable signal.	The sensor is not under the patient's chest (Low confidence condition)	Reposition the sensor under the patient's chest.
	The sensor is turned 90 degrees, placed vertically (Low confidence condition)	Place the sensor horizontally under the patient's mattress, with the cable extending toward the head of the bed.
	There is excessive patient movement (Low confidence condition)	Check the patient. Replace the bed sensor.
	An unqualified mattress type is in use	Switch to a qualified mattress type.
Cannot measure respiration.	The sensor is not under the patient's chest (Low confidence condition)	Adjust the position of the sensor under the patient's chest.
	The sensor is turned 90 degrees, placed vertically (Low confidence condition)	Place the sensor horizontally under the patient's mattress, with the cable extending toward the head of the bed.
	There is excessive patient movement (Low confidence condition)	Check the patient. Replace the bed sensor. Use an alternative sensor to monitor respiration.
	An unqualified mattress type is in use	Switch to a qualified mattress type.
Cannot measure pulse rate.	The sensor is not under the patient's chest (Low confidence condition)	Adjust the position of the sensor under the patient's chest.
	The sensor is turned 90 degrees, placed vertically (Low confidence condition)	Place the sensor horizontally under the patient's mattress, with the cable extending toward the head of the bed.
	There is excessive patient movement (Low confidence condition)	Check the patient. Replace the bed sensor. Use an alternative sensor to monitor pulse rate.
	An unqualified mattress type is in use	Switch to a qualified mattress type.
EarlySense not functional.	A module error occurred	Call for service.
Bed sensor expires in ...	The bed sensor expires soon	Replace the bed sensor before it expires.
The sensor has expired.	The bed sensor has expired	Replace the sensor.

Message	Possible cause	Suggested action
The sensor is defective.	A sensor error occurred	Replace the sensor.
Trend change detected. Review patient history.	Patient measurements have changed enough to require attention	Check the patient and patient history.

## CO2 messages

Message	Possible cause	Suggested action
CO2 not functional. Call for service.	A nonrecoverable communications error has occurred	Call for service.
Filter line disconnected.	The sampling line is not connected to the monitor	Connect a sampling line to the monitor.  Check to ensure that the sampling line plug is tightly connected to the monitor.
Check for occlusion in gas line.	The purge cycle failed to clear a blockage in the sampling line	Replace the sampling line.
CO2 temperature out of range. CO2 might not be accurate.	CO2 module temperature is out of range	Wait for the module temperature to return to normal and the module to reset before calibrating CO2.  Move to a location where the ambient temperature enables the module temperature to return to normal and the module to reset before calibrating CO2.
Connect or clear filter line.	Calibration failed because sampling line is blocked or kinked	Check sampling line for obstruction or kinks. Replace the filter line if necessary.
	Module is not ready for calibration because the sampling line is not connected to the monitor	Check to ensure that the sampling line plug is tightly connected to the monitor.
Purging filter line.	An occlusion was detected in the sampling line, which automatically initiated a purge cycle	Wait for the purge cycle to clear the blockage and the module to be reset.
Check calibration gas concentration.	The calibration gas is not flowing	Check that the calibration gas is turned on.
	The calibration gas has the wrong CO2 concentration	Check that the calibration gas has the correct concentration.
Check calibration gas flow.	The calibration gas flow is unstable	Check the sampling line for kinks or obstructions.

Message	Possible cause	Suggested action
		Check all tubing connections for leaks.
		Check that the gas source is not running out.
Check exhaust port for obstruction.	The exhaust port is blocked Internal flow problem	Call for service.
Calibration overdue. CO2 might not be accurate.	The due date for calibration has passed	Perform CO2 calibration or call for service.
Factory service overdue. CO2 might not be accurate.	The due date for factory service has passed	Call for service.
Calibration failed. <i>Error message here.</i>	The calibration failed for the reason named in the error message	Check the error message and take corrective action presented.
Calibration completed successfully.	An uninterrupted, error-free calibration took place	Resume using the monitor.
Calibration aborted.	You or some other user interrupted the calibration	Resume or retry calibration.

## RRa messages

Message	Possible cause	Suggested action
Respiratory freshness timeout expired.	Excessive ambient or environmental noise	Reduce the level of noise in the room.
	Poor sensor placement on the patient	Remove the sensor from the patient and reapply.
	The patient cable or sensor is defective	Replace the patient cable or sensor.
Replace RRa probe.	The sensor is faulty	Replace the sensor.
	No sensor is connected	Connect the sensor.
	The cable is faulty	Replace the cable.
RRa patient interference detected.	Poor sensor placement on the patient	Remove the sensor from the patient and reapply.
	The patient is talking	Ask the patient to limit talking.
	The patient is snoring	Gently adjust the patient's position to reduce snoring.

Message	Possible cause	Suggested action
		Awaken and ask the patient to adjust their position to reduce snoring.
RRa background interference detected.	Excessive ambient or environmental noise	Reduce the level of noise in the room.

## NIBP messages

Message	Possible cause	Suggested action
NIBP air leak; check cuff and tubing connections.	The NIBP module has an air leak	Check the cuff, tubing, and connections for leaks. If no leaks are found, clear the alarm and retry NIBP.  If the message reappears, call for service to replace the NIBP module.
NIBP not functional. Call for service.	A module error occurred	Call for service.
	The ambient temperature is out of range	Use the monitor in the specified temperature range.
Unable to determine NIBP; check connections; limit patient movement.	The NIBP module detected a motion artifact	Check connections; limit patient movement.  Clear the alarm and retry NIBP.
Unable to determine NIBP; check connections and tubing for kinks.	The NIBP tubing on the outside of the device has a kink	Check the connections and tubing for kinks.  Clear the alarm and retry NIBP.
	The NIBP module needs to be calibrated	Call for service to calibrate the NIBP module.
	Tubing inside the NIBP module is kinked	Call for service to replace the NIBP module.
Incorrect NIBP cuff size; check patient type.	The cuff size is not correct for the selected patient type	Check the patient type and cuff size.  Clear the alarm and retry NIBP.
Inflation too quick; check NIBP cuff and tubing connections.	NIBP inflation was too quick	Check the connections and tubing for kinks.  Clear the alarm and retry NIBP.
Unable to determine NIBP; check inflation settings.	Target pressure is too low	Check inflation settings and change as necessary.

Message	Possible cause	Suggested action
		Clear the alarm and retry NIBP.
		Change the cuff inflation target (CIT).
Excessive patient movement.	The NIBP module detected a motion artifact	Touch <b>OK</b> to dismiss.  Limit patient movement and retry NIBP.
Tube type does not match device configuration.  (NIBP measurement is available)	The tube connected to the NIBP sensor does not match the monitor's configuration	Touch <b>OK</b> to dismiss.  Use the tube type specified for the monitor.
Tube type does not match device configuration.  (NIBP measurement is not available)	User is using a single-lumen tube with the following Advanced settings: 1. Patient type is Pediatric or Adult 2. Tube type is 2 3. Algorithm is SureBP	Clear message. Modify settings or tube use to match patient type.
Time limit exceeded. Unable to complete program.	The averaging program could not be completed within the system time limit	Check connections; limit patient movement.  Clear the alarm and retry the program.
NIBP reading skipped.	NIBP Interval timer reached zero while data was still being entered on the Patients > Manual tab	Touch <b>OK</b> to dismiss. The interval timer will reset and begin counting again.  Touch <b>Save</b> to complete the manual save of vital sign measurements or cancel.

## SpO2 and SpHb messages

Message	Possible cause	Suggested action
SpO2 not functional. Call for service.	A module error has occurred	Try a new cable/sensor pair.  Call for service.
Searching for pulse signal. (High-priority alarm)	The SpO2 sensor is not attached to the patient's finger	Touch the alarm icon or the SpO2 frame to dismiss the alarm.  Set SpO2 alarm limits to OFF.  Reattach the SpO2 sensor to the patient's finger.
Attach SpO2 sensor to monitor.	The sensor was not detected	Check the sensor connection.

Message	Possible cause	Suggested action
		Replace the SpO2 sensor.
Replace the SpO2 sensor.	The SpO2 sensor is faulty or expired	Replace the SpO2 sensor.
	No SpO2 sensor is connected	Connect an SpO2 sensor.
	The cable is faulty or expired	Replace the cable.
Replace the SpO2 cable.	The cable is faulty or expired	Replace the cable.
Low SpO2 signal quality. Check sensor.	Poor sensor placement on the patient	Remove the sensor from the patient and reapply.
Low SpHb signal quality. Check sensor.	The patient cable or sensor is defective	Call service to test or replace the module.
Low perfusion. Check sensor.	The SpO2 module is faulty	Remove the sensor from the patient and reapply.
SpO2 mode only. Check sensor or cable.	The sensor is operating as an SpO2-only sensor because it failed to calibrate properly	Reattach the cable to the monitor.
		Remove the sensor from the patient and reapply.
SpO2 sensor expires in....	The SpO2 sensor will expire soon	Replace the SpO2 sensor.



**NOTE** This message only appears on devices configured with SpHb.

## Temperature messages

Message	Possible cause	Suggested action
Connect temperature probe.	No probe is connected	Connect a temperature probe and retry.
	The probe is faulty	Replace the temperature probe.
	The temperature module returned a connect probe message	Connect a temperature probe and retry. If a probe is already connected, replace the probe.
Insert correct color-coded probe well.	The probe well is missing	Insert a temperature probe well.
Replace temperature probe.	The probe is faulty	Replace the temperature probe.

Message	Possible cause	Suggested action
Temperature not functional. Call for service.	A module error occurred	Call for service.
Temperature time limit exceeded. Retry temperature measurement.	The direct mode timed out	Remove the probe from the measurement site.
Tissue contact lost.	The probe has lost contact with the patient's tissue	Touch <b>OK</b> to dismiss the message. Return the probe to the probe well and retry patient temperature measurement. Ensure that the probe makes proper contact with the patient's tissue.
Retry temperature measurement.	A probe heater or data error occurred	Retry the temperature measurement. If the problem persists, replace the probe.
	User settings require adjustment	Adjust the user settings and retry.
	The ambient temperature is out of range	Operate the monitor within the specified temperature range. Retry patient temperature measurement.
	The SureTemp temperature module is faulty	Call for service.



**NOTE** This message often accompanies other temperature messages.

Unable to detect new temperature. Retry measurement.	The Braun thermometer is removed from the dock or not seated properly in the dock	Return the thermometer to the dock or adjust the thermometer in the dock.
	The Braun dock is disconnected from the device	Connect the USB cable for the Braun dock to the device.
Thermometer might be docked improperly. Check contacts and connections.	The Braun thermometer is removed from the dock or not seated properly in the dock	Return the thermometer to the dock or adjust the thermometer in the dock.
	The Braun dock is disconnected from the device	Connect the USB cable for the Braun dock to the device.

## ECG messages

Message	Possible cause	Suggested action
<b>Alarm</b>		



Message	Possible cause	Suggested action
Electrodes off:	Device configured for 5 leads, but only 3 leads are used	Use 5-lead cable.
IEC electrodes (N, F, R, L, C)	(RA, LA, LL, V) disconnected	Connect (RA, LA, LL, V) lead.
AHA electrodes (RA, LA, LL, V)	(N, F, R, L, C) disconnected	Connect (N, F, R, L, C) lead.
Electrode x off displayed with list of applicable electrodes	Trunk cable disconnected	Connect trunk cable.
ECG not functional.	ECG module error, WACP error, Data failure	Replace the ECG module.
	ECG module has not transmitted ECG data for the past 30 seconds	
	ECG module disconnected	Check ECG connection to Connex device.
	Unexpected alarm compatibility bits	Restart Connex device and ECG module; if error persists, replace ECG module.
Cannot analyze ECG.	Module unable to analyze the ECG signal for V-Tach, V-Fib, and/or asystole	Check electrodes and leads, and replace as needed.
		Replace the ECG module.
Cannot measure ECG.	ECG module has been unable to detect and ECG waveform for the past 30 seconds	Check electrodes and leads, and replace as needed.
		Replace the ECG module.
Searching for respiration.	Good ECG readings no longer available	Check electrodes and leads, and replace as needed.
		Replace the ECG module.
	Attempting to acquire ECG/ Impedance respiration	Check electrodes and leads, and replace as needed.
		Replace the ECG module.
Respiration alarm limits changed.	Respiration physiological alarm limits were modified because the respiration source changed	Reset alarm limits.

## Weight scale messages

Message	Possible cause	Suggested action
Weight scale not functional. Call for service.	The weight scale is not operating properly.	Call for service.

## Physical assessment instrument handles

Symptom	Possible cause	Suggested action
The lamp does not illuminate	There is no lamp in the handle head	Install a lamp in the handle head.
	The lamp is burned out	Install a new lamp.
	The other handle is off the cradle	Place the other handle in the cradle.
	The system is not powered up	Power up the system.
	The platform handle controller PCBA is defective	Call service.
The lamp is too dim	The rheostat setting is too low	Increase the rheostat setting.
	The platform handle controller PCBA is defective	Call service.
	The handle assembly is defective	Call service.
The lamp is too bright	The rheostat setting is too high	Decrease the rheostat setting.
	The platform handle controller PCBA is defective	Call service.
	The handle assembly is defective	Call service.
The lamp brightness does not adjust	The platform handle controller PCBA is defective	Call service.
	The handle assembly is defective	Call service.
The handle becomes very hot to the touch	The lamp has been on for an extended period of time	Return the handle to the cradle.

## Patient data management messages

Message	Possible cause	Suggested action
Maximum number of patient records saved. Oldest record overwritten.	The maximum number of patient records in the monitor's memory has been exceeded	On the Review tab, delete old records to prevent the alarm from appearing when new records are saved.
No data saved.	No patient data is available	Take or enter vital signs before saving.
Patient ID required to save data.	The configuration requires a patient ID to save data	Call for service to modify advanced settings.
Clinician ID required to save data.	The configuration requires a clinician ID to save data	Call for service to modify advanced settings.
Patient ID required to send data.	The configuration requires a patient ID to send data	Add a patient ID.
Patient list is full. Delete some patients to add more.	The maximum number of patients was exceeded	Delete a patient from the list to add a new patient.
Stop intervals to select new patient.	The monitor is set to take interval readings	Stop intervals before changing the patient.
No connection for send.	No connectivity is available to support sending data manually or automatically sending data on manual save	Call for service to check the network connection or wireless settings.
Unable to retrieve list.	The monitor is unable to retrieve a patient list from the network	Call for service to check the network connection or wireless settings, or to verify that the server is available.
Unable to identify clinician.	The clinician ID or password is incorrect	Confirm the clinician ID and password (if applicable), and retry.
Unable to identify patient. Touch Clear to delete all data.	The patient ID does not match an ID in the patient list or network	Re-enter the patient ID.  To delete all unsaved data, touch <b>Clear</b> .
Unable to identify clinician. Touch Clear to delete all data.	The clinician ID does not match an ID in the network	Re-enter the clinician ID.  To delete all unsaved data, touch <b>Clear</b> .
Unable to identify clinician. Host error. Clinician query failed due to host error. Use clinician ID anyway?	The clinician ID or password does not match an ID or password at the host	Re-enter the clinician ID and password.  Accept clinician ID.

Message	Possible cause	Suggested action
Unable to identify clinician. Clinician query failed due to network issue. Use clinician anyway?	Wireless access point out of range Network is down	Call for service to check the network connection or wireless settings, or to verify that the server is available.  Accept clinician ID.
Unable to identify clinician. Invalid ID or system password	The clinician ID does not match an ID in the network	Confirm the clinician ID and password (if applicable), and retry.  Re-enter the clinician ID.

## Communications module messages

Message	Possible cause	Suggested action
Communications module did not power on properly. Power down the device. (High-priority alarm)	Communication failure	Call for service.

## Radio messages

Message	Possible cause	Suggested action
Radio not functional. Call for service.	A hardware failure occurred  The radio has the wrong software	Call for service to update the radio software or replace the radio.
Radio error. Power down and restart.	The device and the radio failed to establish communication with each other	Power down and restart. If problem persists, call for service.
Unable to establish network communications. Radio out of network range.	The radio is no longer communicating with the access point	Call for service to verify that the device is within the radio coverage area and is configured to the network.
Unable to establish network communications. Call for service.	The radio is unable to get an IP address from the DHCP server	Call for service to verify that the server is available.
Configuration is invalid without certificates. Reconfigure and try again.	The configuration is invalid for installed radio certificates and/or PAC file  You attempted to load corrupted radio certificates	Restore factory defaults for radio settings to clear out the certificate. Then configure the radio appropriately.  Reload a valid certificate package into the radio.

## Ethernet messages

Message	Possible cause	Suggested action
Network not found; check network cable connection.	A network cable is unplugged	Check the network cable connection. If problem persists, call for service.
	A network connection is broken elsewhere	

## USB and USB flash drive messages

Message	Possible cause	Suggested action
USB Communication failure. Call for service.	An internal or external device is connected but failed enumeration	Power down and restart.
		Check USB connections.
		If problem persists, call for service.
External device not licensed for use.	A license for an external device (e.g., barcode scanner) has not been activated	Disconnect the unlicensed device.
		Call for service to obtain the authorization code from Welch Allyn to activate the license.
External device not recognized.	An unrecognized external device is connected	Disconnect the unrecognized device.
Incompatible Welch Allyn device.	A communication protocol failure has occurred	Call for service.
USB accessory disconnected.	The USB cable between an external device and the monitor is disconnected	Confirm that the USB cable is connected to the device and the monitor.
Save not successful.	Missing, improperly inserted, or incompatible USB flash drive	Dismiss message and insert a compatible USB flash drive.
Unable to save configuration to USB.	Missing, improperly inserted, or incompatible USB flash drive	Dismiss message and insert a compatible USB flash drive.

## System messages

Message	Possible cause	Suggested action
Set date and time.	The date or time is not set	Set the date and time.
	The date or time is not set properly	Reset the date or time.

Message	Possible cause	Suggested action
Device shutdown is not available at this time.	Device cannot perform an immediate shutdown	Touch <b>OK</b> , wait, and retry.
Advanced settings unavailable.	Sensors are taking measurements	Stop continuous measurements.
	A physiological alarm condition is active	Respond to or reset the alarm.
	Spot Check measurements have not been saved	Save the measurements.
Unexpected restart occurred. Call for service.	A system error caused the monitor to restart.	Call for service.

## Battery power manager messages

Message	Possible cause	Suggested action
Low battery 5 minutes or less remaining. (High-priority alarm)	Battery power is extremely low	Connect the monitor to AC power. (If not connected to AC power, the monitor powers down when battery power is depleted.)
Low battery 30 minutes or less remaining.	Battery power is low	Touch the alarm icon to dismiss or connect the monitor to AC power.
Battery is absent or faulty.	There is no battery in the monitor	Insert a battery.
Battery is absent or faulty. Call for service.	The battery is faulty	Replace the battery.
Device is operating in battery mode.	The AC power cord has been disconnected	Touch <b>OK</b> to dismiss or connect the monitor to AC power.

## Configuration Manager messages

Message	Possible cause	Suggested action
Unable to load configuration; using factory defaults.	A configuration load error occurred	Call for service.
Functional error. Call for service.	A critical configuration load error occurred	Call for service.
No connection for send.	The monitor is not configured to the network	Call for service.

## Printer messages

Message	Possible cause	Suggested action
Low battery, unable to print; plug into outlet.	The monitor's battery voltage is too low to support printing	Connect the monitor to AC power.
Printer door is open; close to continue.	The printer door is open	Close the printer door.
Out of paper.	The paper is not properly loaded	Align the paper with the print head. If the problem persists, call for service.
	The paper sensor does not detect paper	Replace the paper. If the problem persists, call for service.
Printer too hot; wait to retry.	The print head overheated	Wait for the print head to cool down and retry. If the problem persists, call for service.
External device not recognized.	An external printer is plugged into a USB port	Unplug the external printer.
Printer not functional. Call for service.	The printer motor is broken	Call for service.
	The detection switch malfunctioned	
	A hardware failure occurred in the power supply	
	The printer does not identify itself correctly	
	The printer does not enumerate	
Printing records:	The monitor is printing the records selected on the Review tab	Acknowledge the number of records printing or touch <b>Cancel</b> to interrupt printing.
 <b>NOTE</b> The number of records requested appears in the message and counts down during printing.		
	Printing report; please wait.	The printer needs more time to complete a print job when the <b>Automatic print on interval</b> control has been enabled

## Network messages

Message	Possible cause	Suggested action
Lost connectivity with host.	The central station or other host application has stopped running or is not operating properly	Confirm that the host application is running properly.
Failed to authenticate to server.	Device is configured for server authentication, but server authentication failed for one of the following reasons: <ul style="list-style-type: none"> <li>the domain name of the server does not match the one reported in the server certificate</li> <li>the certificate is expired (no longer within the validity period)</li> <li>the certificate has not been verified</li> <li>the certificate has been revoked</li> </ul>	Make sure server certificates are valid. Make sure the correct CA certificate file exists on the device to authenticate the server certificate.
	The server is not configured for authentication	Check the server configuration. Make sure authentication is configured correctly. Disable the server authentication option on the device.
Single sign on only available to confirm manual episodic save in Continuous Monitoring profile.	The information message indicates that Single sign on is only available as part of the confirmation process for a manual episodic save.	
Host software does not support manual episodic save in Continuous Monitoring profile.	The central station software is an older version that does not support episodic save	Confirm that the host application is running properly. Check the server configuration software version.

## Problems and solutions

The problems addressed in this table do not generate alarm or information messages on the monitor.

Problem	Possible cause	Suggested action
No SpHb value is displayed	An SpO2-only cable is connected to the monitor	Replace the SpO2-only cable with an SpO2/SpHb (Masimo rainbow) cable.
	The SpO2/SpHb reusable sensor has expired	Replace the sensor.



Problem	Possible cause	Suggested action
	 <b>NOTE</b> A technical alarm appears.	
	Poor sensor placement on the patient	Remove the sensor from the patient and reapply.
	The monitor may have the SpHb license, but the SpO2 module does not	Contact Welch Allyn to verify that the SpO2 module contains the SpHb license.
No weight measurement is transferred from the scale to the monitor	The scale is not connected	Inspect the USB cables from the device to the adapter to the scale to ensure that they are connected properly.
	The scale setting is incorrect	Ensure that the scale settings are enabled for transfer.
No BMI value is displayed in the Office profile	The weight measurement is out of range The height measurement is out of range	Manually adjust the measurement.  Use the attached weight scale to retake the measurement.
The Office profile does not appear in the Profiles tab	The Office profile license is not installed	Purchases a license and install the license using the service tool.

## Lead-quality problems

### Artifact or noisy waveform

Artifact is signal distortion that makes it difficult to accurately discern the waveform morphology.

#### Causes

- The patient was moving.
- The patient was shivering.
- There is electrical interference.

#### Actions

See actions for wandering baseline, muscle tremor, and AC interference.

### Wandering baseline

Wandering baseline is an upward and downward fluctuation of the waveforms.

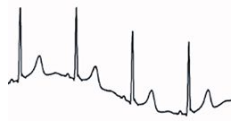

#### Causes

- Electrodes are dirty, corroded, loose, or positioned on bony areas.
- The electrode gel is insufficient or dried.
- The patient has oily skin or used body lotions.
- Rising and falling of chest during rapid or apprehensive breathing.

#### Actions

- Clean the patient's skin with alcohol or acetone. Take care not to irritate the skin.
- Reposition or replace the electrodes.
- Verify that the patient is comfortable, warm, and relaxed.

## Muscle tremor



#### Causes

- The patient is uncomfortable, tense, nervous.
- The patient is cold and shivering.
- The exam bed is too narrow or short to comfortably support arms and legs.
- The arm or leg electrode straps are too tight.

#### Actions

- Verify that the patient is comfortable, warm, and relaxed.
- Check all electrode contacts.
- If interference persists, turn on the filter. If interference still persists, the problem is probably electrical in nature. See the suggestions for reducing AC interference.

## AC interference

AC interference superimposes voltage on the waveforms.

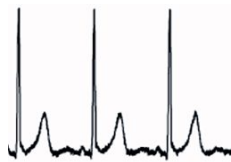

#### Causes

- The patient or technician was touching an electrode during recording.
- The patient was touching a metal part of an exam table or bed.
- A lead wire, patient cable, or power cord are broken.

- Electrical devices in the immediate area, or lighting, or wiring concealed in walls or floors are interfering.
- An electrical outlet is improperly grounded.

**Actions**

- Verify that the patient is not touching any metal.
- Verify that the USB cable is not touching the patient cable.
- Verify that the AC filter is selected.
- Verify that the AC filter is set to proper frequency.
- If interference persists, the noise may be caused by other equipment in the room or by poorly grounded power lines.

## Lead alert or square wave



One or more leads might appear as a square wave.

**Causes**

- The signal from an electrode has not yet stabilized after placing it.
- Electrodes are dirty, corroded, loose, or positioned on bony areas.
- The electrode gel is insufficient or dried.
- The patient has oily skin or used body lotions.

**Actions**

- Verify that the patient’s skin has been properly prepared.
- Verify that electrodes have been properly stored and handled.
- Replace the electrode.
- Replace the patient cable.

## Analysis errors

Condition	Possible cause	Suggested action
Incorrect heart rate	Low amplitude signal causes misdetection and creates long coupling interval.	Reposition electrode to increase signal amplitude.
	Artifact prevents QRS detections, creating long coupling interval.	
	Excessively noisy trace causes false interpolated beats.	Improve preparation for patient hookup.
	Excessively noisy trace causes distortion of original QRS signal.	
	Prematurity threshold in clinical settings is set too low.	

Condition	Possible cause	Suggested action
	Excessively noisy trace causes false interpolated beats, artificially elevating heart rate. Low amplitude signal causes no detection.	
Low heart rate	Low amplitude signal causes no detection. Low heart rate threshold is set too high.	Improve preparation for patient hookup. Check that low heart rate threshold is set to desired threshold.
High heart rate	Excessively noisy trace causes false interpolated beats. High heart rate threshold is set too low.	Improve preparation for patient hookup. Check that high heart rate threshold is set to desired threshold.
Low respiration rate	Low amplitude signal causes no detection. Low respiration rate threshold is set too high.	Improve preparation for patient hookup. Check that low respiration rate threshold is set to desired threshold.
High respiration rate	Excessively noisy trace causes false interpolated beats. High respiration rate threshold is set too low.	Improve preparation for patient hookup. Check that high respiration rate threshold is set to desired threshold.
False pacer detection	Excessively noisy trace causes false pacer detections.	Disable pacer detection if patient does not have a pacemaker.

# Specifications

## Physical specifications

### Protection classifications, all monitor configurations

Characteristic	Specification
Electrical rating	100 – 240 V AC, 50 – 60 Hz, 0.8 – 1.5 A
Duty cycle	Continuous operation
Duty cycle – physical assessment handles	2 minutes on, 10 minutes off
Type of protection against electric shock	Class I equipment (protectively earthed) with double insulation
Degree of protection against electric shock, for parts applied to patients	Type BF defibrillator proof IEC EN 60601-1
Recovery time following defibrillator discharge	Less than or equal to 10 seconds
Flammable anesthetics	 <b>WARNING</b> Not suitable for use with flammable anesthetics.
Degree of protection provided by the enclosure with respect to harmful ingress of liquids	IPX2 Protection against vertically falling water drops when enclosure tilted up to 15° (Vital Signs Monitor) IPX0 (Integrated Wall System)

### Vital Signs Monitor 6000 Series

Height	Standard chassis: 10 in. (25.4 cm) Extended chassis: 10 in. (25.4 cm)
Width	Standard chassis: 11.4 in. (28.96 cm) Extended chassis: 11.4 in. (28.96 cm)

---

**Protection classifications, all monitor configurations**

---

Depth	Standard chassis: 6 in. (15.3 cm) Extended chassis: 7.5 in. (19.1 cm)
-------	--

Weight (including battery)	Standard chassis: 9.5 lb (4.3 kg) Extended chassis: 10.4 lb (4.7 kg)
----------------------------	---

---

**Integrated Wall System**

---

Height	10.5 in. (26.8 cm)
--------	--------------------

Width	39.9 in. (101.4 cm)
-------	---------------------

Depth	7.5 in. (19.1 cm)
-------	-------------------

Weight (including battery)	14.1 lb. (6 kg)
----------------------------	-----------------

---

**Graphical display resolution**

---

Display area	8 in. (H) x 4 in. (V) (19.5 [H] cm x 11.3 [V] cm)
--------------	---

Pixels	1024 (H) x 600 (V)
--------	--------------------

Pixel arrangement	RGB (red, green, blue)
-------------------	------------------------

Color depth	16 bits per pixel
-------------	-------------------

---

**Speaker volume**

---

**Vital Signs Monitor 6000 Series**

---

High priority alarm sound pressure level	47-92 dBA at 1.0 meter
--	------------------------

Medium priority alarm sound pressure level	45-82 dBA at 1.0 meter
--	------------------------

---

**Integrated Wall System**

---

High priority alarm sound pressure level	42-78 dBA at 1.0 meter
--	------------------------

Medium priority alarm sound pressure level	42-75 dBA at 1.0 meter
--	------------------------

---

<b>Alarm and pulse tones</b>	per IEC 60601-1-8
------------------------------	-------------------

Pulse frequency ( $f_0$ )	150 – 1000 Hz
---------------------------	---------------

Number of harmonic components in the range 300 Hz to 4000 Hz	minimum of 4
--	--------------

---

---

**Protection classifications, all monitor configurations**

---

Effective pulse duration ( $t_d$ )	high priority: 75 – 200 ms medium and low priority: 125 – 250 ms
------------------------------------	---

Rise time ( $t_r$ )	10 – 40% of $t_d$
---------------------	-------------------

Fall time <sup>a</sup> ( $t_f$ )	$t_f \leq t_s - t_r$
----------------------------------	----------------------

Maximum delay for lost connection with host notification	4 seconds
--	-----------

---



**NOTE** The relative sound pressure level of the harmonic components should be within 15 dB above or below the amplitude at the pulse frequency.



**NOTE** See the "Alarm delays" table later in this section.

---

<sup>a</sup> Prevents overlap of pulses.

---

Battery specifications	3 cell (Integrated Wall System)	9 cell (Vital Signs Monitor)
Composition	Lithium-ion	Lithium-ion
Charge time to 100% capacity	Always plugged in	6 hr
Age to 70% capacity <sup>1</sup>	300	300

<sup>1</sup>After this many full charge and discharge cycles, the battery has aged to where its total capacity has been reduced to 70% of its rating.

---

**Ethernet connection specifications**

---

Ethernet	Communicates using 10base-T and 100-base T
----------	--

---

**Nurse Call connection specifications**

---

Nurse Call	50V DC maximum at 500mA (DC or ACRMS)
------------	---------------------------------------

---

**Handle specifications**

---

Handle output	3.00 - 3.90 V, .700 - 1.5 A
---------------	-----------------------------

---

Leakage current is less than 10 microamps from any exposed metal part.

---

---

**NIBP specifications**

---

Units of measure	Systolic, diastolic, MAP: mmHg, kPa; user-selectable Pulse rate: beats per minute
Cuff pressure range	Meets or exceeds ANSI/AAMI SP10:2002 standards for cuff pressure range
Systolic range	Adult: 30 to 260 mmHg (4.0 to 34.7 kPa) (StepBP, SureBP) Pediatric: 30 to 260 mmHg (4.0 to 34.7 kPa) (StepBP, SureBP) Neonate: 20 to 120 mmHg (2.7 to 16.0 kPa) (StepBP)
Diastolic range	Adult: 20 to 220 mmHg (2.7 to 29.3 kPa) (StepBP, SureBP) Pediatric: 20 to 220 mmHg (2.7 to 29.3 kPa) (StepBP, SureBP) Neonate: 10 to 110 mmHg (1.3 to 14.7 kPa) (StepBP)
Cuff Inflation Target	Adult: 160 mmHg (21.3 kPa) (StepBP) Pediatric: 140 mmHg (18.7 kPa) (StepBP) Neonate: 90 mmHg (12.0 kPa) (StepBP)
Maximum Target Pressure	Adult: 280 mmHg (37.3 kPa) (StepBP, SureBP) Pediatric: 280 mmHg (37.3 kPa) (StepBP, SureBP) Neonate: 130 mmHg (17.3 kPa) (StepBP)
Blood pressure determination time	Typical: 15 seconds Maximum: 150 seconds
Blood pressure accuracy	Meets or exceeds ANSI/AAMI SP10:2002 standards for noninvasive blood pressure accuracy, $\pm 5$ mmHg (0.7 kPa) mean error, 8 mmHg (1.1 kPa) standard deviation
Mean Arterial Pressure (MAP) range The formula used to calculate MAP yields an approximate value.	Adult: 23 to 230 mmHg (3.1 to 30.7 kPa) (StepBP, SureBP) Pediatric: 23 to 230 mmHg (3.1 to 30.7 kPa) (StepBP, SureBP) Neonate: 13 to 110 mmHg (1.7 to 14.7 kPa) (StepBP)
Pulse rate range (using blood pressure determination)	Adult: 30 to 200 beats per minute (StepBP, SureBP) Pediatric: 30 to 200 beats per minute (StepBP, SureBP) Neonate: 35 to 220 beats per minute (StepBP)
Pulse rate accuracy (using blood pressure determination)	$\pm 5.0\%$ ( $\pm 3$ beats per minute)
Overpressure cutoff	Adult: 300 mmHg $\pm 15$ mmHg (40.0 kPa $\pm 2.0$ kPa) Pediatric: 300 mmHg $\pm 15$ mmHg (40.0 kPa $\pm 2.0$ kPa)

---



---

**NIBP specifications**

---

Neonate: 150 mmHg (20.0 kPa) maximum

---



**NOTE** NIBP performance can be affected by extremes of humidity, temperature, and altitude.

---



---

**SureTemp Plus temperature module specifications**

---

Units of measure °F, °C; user-selectable

---

Temperature range 80 °F to 110 °F (26.7 °C to 43.3 °C)

---

**Temperature measurement range Accuracy**

---

Less than 37.0 °C ±0.2 °C

---

37.0 °C to 39.0 °C ±0.1 °C

---

Greater than 39.0 °C ±0.2 °C

---

Less than 96.4 °F ±0.4 °F

---

96.4 °F to less than 98.0 °F ±0.3 °F

---

98.0 °F to 102.0 °F ±0.2 °F

---

102.0 °F to 106.0 °F ±0.3 °F

---

Greater than 106.0 °F ±0.4 °F

---



---

**Braun ThermoScan PRO thermometer specifications (refer to manufacturer's instructions for use for additional information)**

---

Units of measure °F, °C; user-selectable

---

Temperature range 68 °F to 108 °F (20 °C to 42.2 °C)

---

Calibration accuracy

- ±0.4 °F (±0.2 °C) for temperatures ranging from 95.9 °F to 107.6 °F (35.5 °C to 42 °C)
- ±0.5 °F (±0.3 °C) for temperatures outside of this range

---

Display resolution 0.1 °F or 0.1 °C

---



---

**SpO2**

---



**WARNING** Functional testers cannot be used to assess the accuracy of a pulse oximeter monitor.

Some models of commercially available bench-top functional testers and patient simulators can be used to verify the proper functionality of Nellcor and Masimo pulse oximeter sensors, cables and monitors. See the individual testing device's operator's manual for the procedures specific to the model of tester being used.

While such devices may be useful for verifying that the pulse oximeter sensor, cabling, and monitor are functional, they are incapable of providing the data required to properly evaluate the accuracy of a system's SpO2 measurements. Fully evaluating the accuracy of the SpO2 measurements requires, at a minimum, accommodating the wavelength characteristics of the sensor and reproducing the complex optical interaction of the sensor and the patient's tissue. These capabilities are beyond the scope of known bench-top testers. SpO2 measurement accuracy can only be evaluated in vivo by comparing pulse oximeter readings with SaO2 measurements obtained from simultaneously sampled arterial blood made using a laboratory CO-oximeter.

Many functional testers and patient simulators have been designed to interface with the pulse oximeter's expected calibration curves and may be suitable for use with Nellcor and Masimo monitors and/or sensors. Not all such devices, however, are adapted for use with the Nellcor OXIMAX or Masimorainbow SET digital calibration system. While this will not affect use of the simulator for verifying system functionality, displayed SpO2 measurement values may differ from the setting of the test device. For a properly functioning monitor, this difference will be reproducible over time and from monitor to monitor within the performance specifications of the test device.

**Nellcor specifications (for additional information, refer to the instructions for use that accompanies each accessory)**

**SpO2**



**NOTE** Contact the sensor manufacturer for further SpO2 clinical testing information.



**NOTE** Refer to sensor manufacturers' instructions for use for further accuracy information.

Unit of measure	%
Measurement range	1% to 100%
Nellcor sensor accuracy guide	SpO2 measurement accuracy can only be evaluated in vivo by comparing pulse oximeter readings with SaO2 measurements obtained from simultaneously sampled arterial blood made using a laboratory CO-oximeter. SpO2 accuracy was validated through breathe-down-equivalent testing by Covidien using electronic measurements to prove equivalence to the Nellcor N600x predicate device. The Nellcor N600x predicate device was validated by performing human-subject, "breathe-down" clinical trials.

Accuracy



**NOTE** Saturation accuracy varies by sensor type. The worst case accuracy range of the module or the attached sensor will apply.

**Nellcor specifications (for additional information, refer to the instructions for use that accompanies each accessory)**

Saturation accuracy (module)	<p>±3 digits</p> <p>70% to 100%</p> <p>Adult, Pediatrics: ± 2 digits</p> <p>Neonate: ± 3 digits</p> <p>Low Perfusion: 0.02% to 20% ± 2 digits</p>																		
Saturation accuracy (sensors)	<table border="1"> <thead> <tr> <th>Sensor</th> <th>Accuracy</th> </tr> </thead> <tbody> <tr> <td>MAX-AI, MAX-PI, MAX-II</td> <td>±3 digits</td> </tr> <tr> <td>DS-100A</td> <td>±3 digits</td> </tr> <tr> <td>D-YS</td> <td>Infants, Pediatrics, Adults: ±3 digits Neonates: ±4 digits</td> </tr> <tr> <td>D-YSE</td> <td>±4 digits</td> </tr> <tr> <td>D-YSPD</td> <td>±4 digits</td> </tr> <tr> <td>MAX-AI, MAX-PI, MAX-II</td> <td>±2 digits</td> </tr> <tr> <td>OXI-A/N</td> <td>Adults: ±3 digits Neonates: ±4 digits</td> </tr> <tr> <td>OXI-P/I</td> <td>±3 digits</td> </tr> </tbody> </table>	Sensor	Accuracy	MAX-AI, MAX-PI, MAX-II	±3 digits	DS-100A	±3 digits	D-YS	Infants, Pediatrics, Adults: ±3 digits Neonates: ±4 digits	D-YSE	±4 digits	D-YSPD	±4 digits	MAX-AI, MAX-PI, MAX-II	±2 digits	OXI-A/N	Adults: ±3 digits Neonates: ±4 digits	OXI-P/I	±3 digits
Sensor	Accuracy																		
MAX-AI, MAX-PI, MAX-II	±3 digits																		
DS-100A	±3 digits																		
D-YS	Infants, Pediatrics, Adults: ±3 digits Neonates: ±4 digits																		
D-YSE	±4 digits																		
D-YSPD	±4 digits																		
MAX-AI, MAX-PI, MAX-II	±2 digits																		
OXI-A/N	Adults: ±3 digits Neonates: ±4 digits																		
OXI-P/I	±3 digits																		
Electrical/Optical Specifications	<p>Nellcor pulse oximetry sensors contain light-emitting diodes (LEDs) that emit red light at a wavelength of approximately 660 nm, and infrared light at a wavelength of approximately 900 nm. The total optical output power of the sensor LEDs is less than 15 mW. This information might be useful to clinicians, such as those performing photodynamic therapy.</p>																		
<b>Pulse rate</b>																			
Unit of measure	beats per minute																		
Measurement range	20 to 250 beats per minute																		
Accuracy	±3 digits																		

---

**Masimo specifications (for additional information, refer to the instructions for use that accompanies each accessory)**

---

**SpO<sub>2</sub>**

**NOTE** Contact the sensor manufacturer for further SpO<sub>2</sub> clinical testing information.



**NOTE** Refer to sensor manufacturers' instructions for use for further accuracy information.

---

Unit of measure	%
Measurement range	0% to 100%

---

Masimo SpO<sub>2</sub> sensor accuracy guide

Accuracy specified when used with Masimo SET pulse oximetry monitors or with licensed Masimo SET pulse oximetry modules using PC series patient cables, during no motion. Numbers present  $\pm 1$  standard deviation. Plus or minus one standard deviation represents 68% of the population.

Accuracy<sup>1</sup>

**NOTE** Saturation accuracy varies by sensor type. For additional sensor accuracy information, refer to the DFU that accompanies the sensor.

70% to 100%

Adults, Infants, Pediatrics (no motion<sup>2</sup>):  $\pm 2\%$

Neonates (no motion<sup>2</sup>):  $\pm 3\%$

Adults, Infants, Pediatrics, Neonates (motion<sup>3</sup>):  $\pm 3\%$

Adults, Infants, Pediatrics, Neonates (low perfusion<sup>4</sup>):  $\pm 2\%$

---

Resolution	1%
------------	----

---

## Electrical/Optical Specifications

Masimo pulse oximetry uses multi-wavelength sensors that contain light-emitting diodes (LEDs) that emit visible light and infrared light at wavelengths from approximately 500 nm to approximately 1000 nm. The maximum radiant power of the strongest light is less than or equal to 25 mW. This information might be useful to clinicians, such as those performing photodynamic therapy.

**Perfusion Index**

---

Measurement range	0.1% to 20.0%
-------------------	---------------

---

**Pulse rate**

---

Unit of measure	beats per minute
-----------------	------------------

---

Measurement range	25 to 240 beats per minute
-------------------	----------------------------

---

---

**Masimo specifications (for additional information, refer to the instructions for use that accompanies each accessory)**

---

Accuracy <sup>5</sup>	Adults, Infants, Pediatrics, Neonates (no motion): $\pm 3$ beats per minute
	Adults, Infants, Pediatrics, Neonates (motion): $\pm 5$ beats per minute
	Adults, Infants, Pediatrics, Neonates (low perfusion <sup>4</sup> ): $\pm 3$ beats per minute

---

Resolution	1 beat per minute
------------	-------------------

---

**SpHb**

---

Units of measure	g/dL, mmol/L; user-selectable
Measurement range	0.0 to 25.0 g/dL (0.0 to 15.5 mmol/L)
Accuracy <sup>6</sup>	Adults, Pediatrics (no motion): 8 to 17 g/dL $\pm 1$ g/dL
Resolution	0.1 g/dL or mmol/L

---

**RRa**

---

Unit of measure	breaths per minute
Body weight	Adult >66 pounds (30 kilograms)
Measurement range	0 to 70 breaths per minute
Accuracy <sup>7</sup>	Adults: 4 to 70 $\pm 1$ breath per minute
Resolution	1 breath per minute

---

<sup>1</sup> SpO<sub>2</sub> accuracy was determined by testing on healthy adult volunteers in the range of 60% to 100% SpO<sub>2</sub> against a laboratory CO-Oximeter. SpO<sub>2</sub> accuracy was determined on 16 neonatal NICU patients ranging in age from 7 to 135 days old and weighing between 0.5 and 4.25 kg. Seventy-nine (79) data samples were collected over a range of 70% to 100% SaO<sub>2</sub> with a resultant accuracy of 2.9% SpO<sub>2</sub>. Contact Masimo for testing specifications.

<sup>2</sup> The Masimo sensors have been validated for no-motion accuracy in human blood studies on healthy adult male and female volunteers with light to dark skin pigmentation in induced hypoxia studies in the range of 70% to 100% SpO<sub>2</sub> against a laboratory CO-Oximeter and ECG monitor. This variation equals  $\pm 1$  standard deviation which encompasses 68% of the population.

<sup>3</sup> The Masimo sensors have been validated for motion accuracy in human blood studies on healthy adult male and female volunteers with light to dark skin pigmentation in induced hypoxia studies while performing rubbing and tapping motions, at 2 to 4 Hz at an amplitude of 1 to 2 cm and a non-repetitive motion between 1 to 5 Hz at an amplitude of 2 to 3 cm in induced hypoxia studies in the range of 70% to 100% SpO<sub>2</sub> against a laboratory CO-Oximeter and ECG monitor. This variation equals  $\pm 1$  standard deviation which encompasses 68% of the population.

<sup>4</sup> The Masimo rainbow SET CO-Oximeter module has been validated for low-perfusion accuracy in bench-top testing against a Fluke Biotek Index 2 simulator and Masimo's simulator with signal strengths of greater than 0.02% and transmission of greater than 5% for saturations and pulse rates within the stated accuracy specifications. This variation equals  $\pm 1$  standard deviation which encompasses 68% of the population.

---

---

**Masimo specifications (for additional information, refer to the instructions for use that accompanies each accessory)**

---

<sup>5</sup> The Masimo sensors have been validated for pulse rate accuracy for the range of 25 to 240 beats per minute in bench-top testing against a Biotek Index 2 simulator. This variation equals  $\pm 1$  standard deviation which encompasses 68% of the population.

<sup>6</sup> SpHb accuracy has been validated on healthy adult male and female volunteers and on surgical patients with light to dark skin pigmentation in the range of 8 g/dL to 17 g/dL SpHb against a laboratory CO-Oximeter. The variation equals  $\pm 1$  standard deviation which encompasses 68% of the population. The SpHb accuracy has not been validated with motion or low perfusion.

<sup>7</sup> Respiration rate accuracy for the RRa sensor and instrument has been validated for the range of 4 to 70 breaths per minute in bench-top testing. Clinical validation for up to 30 breaths per minute was also performed with the RRa sensor and instrument.

---



---

**CO2 specifications (for additional information, refer to the instructions for use that accompanies each accessory)**

---

Capnography is a non-invasive method for monitoring the level of carbon dioxide in exhaled breath (etCO<sub>2</sub>) to assess a patient's ventilatory status.

Capnostream uses Microstream non-dispersive infrared (NDIR) spectroscopy to continuously measure the amount of CO<sub>2</sub> during every breath, the amount of CO<sub>2</sub> present at the end of exhalation (etCO<sub>2</sub>), the amount of CO<sub>2</sub> present during inhalation (FiCO<sub>2</sub>), and the Respiratory Rate. Infrared spectroscopy is used to measure the concentration of molecules that absorb infrared light. Because the absorption is proportional to the concentration of the absorbing molecule, the concentration can be determined by comparing its absorption to that of a known standard.

The Microstream etCO<sub>2</sub> consumables deliver a sample of the inhaled and exhaled gases from the ventilator consumable or directly from the patient (via an oral/nasal cannula) into the monitor for CO<sub>2</sub> measurement. Moisture and patient secretions are extracted from the sample, while maintaining the shape of the CO<sub>2</sub> waveform. The 50 ml/min. sampling flow rate reduces liquid and secretion accumulation, decreasing the risk of obstruction in the sample pathway in humid ICU environments. Once inside the Microstream CO<sub>2</sub> sensor, the gas sample goes through a micro-sample cell (15 microliters). This extremely small volume is quickly flushed, allowing for fast rise time and accurate CO<sub>2</sub> readings, even at high respiration rates. The Micro Beam IR source illuminates the micro-sample cell and the reference cell. This proprietary IR light source generates only the specific wavelengths characteristic of the CO<sub>2</sub> absorption spectrum. Therefore, no compensations are required when different concentrations of N<sub>2</sub>O, O<sub>2</sub>, anesthetic agents and water vapor are present in the inhaled and exhaled breath. The IR that passes through the micro-sample cell and the IR that passes through the reference cell are measured by the IR detectors. The microprocessor in the monitor calculates the CO<sub>2</sub> concentration by comparing the signals from both detectors.

---

Accuracy <sup>1</sup>	0 to 38 mmHg: $\pm 2$ mmHg 39 to 150 mmHg: $\pm(5\%$ of reading + 0.08% for every 1 mmHg above 38 mmHg)
Flow rate	50 (42.5 $\leq$ flow $\leq$ 65) ml/min, flow measured by volume
Initialization time	40 seconds (typical, includes power-up and initialization time)
System response time	7 seconds (typical, includes module response time and host monitor system response time)

---

---

**CO<sub>2</sub> specifications (for additional information, refer to the instructions for use that accompanies each accessory)**

---

## Compensation

**Pressure**

The CO<sub>2</sub> module is equipped with a barometric pressure transducer and compensation is triggered at startup or during other events (significant changes in temperature, ambient pressure, etc.).

BTPS (standard correction used by Microstream capnography during all measurement procedures for body temperature, pressure, and saturation).

**Gases**

The Microstream emitter radiates a focused beam of infrared energy characterized by the narrow region (0.15 μm wide) of the spectrum where CO<sub>2</sub> molecules absorb infrared radiation. Because MCS™ is highly accurate with all gas samples, there is no need to create special algorithms within the monitor to correct for high concentrations of oxygen or anesthetic gases.

## Cyclical pressure

≤ 10 kPa (100 cmH<sub>2</sub>O); module operates within specification with overpressure up to 100 cmH<sub>2</sub>O

## Sampled gas return/disposal

Sampled gases are not returned to the breathing circuit. Exhaled gas is exhausted from the monitor's exhaust port. Dispose of sampled gases according to facility requirements or local regulations.

## Sampling rate

20 samples per second

## Calibration interval

Initial: After 1200 operating hours  
Subsequent: After 4000 operating hours or annually (whichever comes first)

## Periodic service

After 30,000 operating hours

**etCO<sub>2</sub>**

## Units of measure

mmHg, kPa; user-selectable

## Display range

0 to 150 mmHg (0.0 to 20.0 kPa)

## Resolution

1 mmHg, 0.1 kPa

## Frequency response

The device maintains etCO<sub>2</sub> accuracy up to 80 breaths/min. From 81 to 150 bpm, accuracy is ±12%.

**FICO<sub>2</sub>**

## Units of measure

mmHg, kPa; user-selectable

## Display range

0 to 150 mmHg (0.0 to 20.0 kPa)

## Resolution

1 mmHg, 0.1 kPa

---

---

**CO<sub>2</sub> specifications (for additional information, refer to the instructions for use that accompanies each accessory)**

---

**IPI**

Display range	1 to 10
---------------	---------

---

**RR**

Unit of measure	breaths per minute
-----------------	--------------------

---

Display range	0 to 150 breaths per minute
---------------	-----------------------------

---

Accuracy	0 to 70 breaths per minute: ±1 breath per minute
	71 to 120 breaths per minute: ±2 breaths per minute
	121 to 150 breaths per minute: ±3 breaths per minute

---

Resolution	1 breath per minute
------------	---------------------

---

<sup>1</sup> For breath rates above 80 bpm, accuracy is 4 mmHg or ±12% of reading (whichever is greater) for etCO<sub>2</sub> values exceeding 18 mmHg when measured in accordance with ISO 80601-2-55.

---



---

**EarlySense specifications**

---

**Sensor**

Dimensions	300 mm x 210 mm x 2.5 mm
------------	--------------------------

---

Weight	160 g
--------	-------

---

Material	Polycarbonate + ABS
----------	---------------------

---

Connector	RS232 (S11M03-P04M500-5260(ODU))
-----------	----------------------------------

---

**Sensor power supply**

Electrical absolute maximum current, DC in	Minimum: -0.3 V
	Maximum: 5.5 V

---

Operating current	Minimum: 4.9 V
	Typical: 5.0 V
	Maximum: 5.2 V

---

Power consumption at 5V operating current	Minimum: 1 mA
	Maximum: 4 mA

---

**Module**

Dimensions	135 mm x 75 mm x 1.0 mm
------------	-------------------------

---



---

**EarlySense specifications**

---

Weight	800 g
--------	-------

---

Host connection	USB Mini-B
-----------------	------------

---

**Module power supply**

---

Electrical absolute maximum current, DC in	Minimum: -0.3 V Maximum: 5.5 V
--	-----------------------------------

---

Operating current	Main power supply: Minimum: 4.9 V Typical: 5.0 V RTC backup battery voltage: Minimum: 2.5 V Typical: 3.0 V Maximum: 3.2 V
-------------------	---

---

Power consumption at 5V operating current	Minimum: 4 mA Maximum: 400 mA
---	----------------------------------

---

**Patient movement**

---

Movement during defined period (1.5 minutes)	0 = 0% L = Up to 40% M = 40% to 60% H = 60% to 80% EH = 80% to 100%
--	---

---

Accuracy	Adult: 0 = 100%, L = 100%, M = 81%, H = 100%, EH = 96% Pediatric: 0 = 100%, L = 100%, M = 81%, H = 86%, EH = 94%
----------	---

---

Averaging period	15 seconds
------------------	------------

---

**Respiration rate**

---

Unit of measure	breaths per minute
-----------------	--------------------

---

Measurement range	6 to 45 breaths per minute <sup>1</sup>
-------------------	---

---

Accuracy <sup>2</sup>	±4% or ±1.5 breaths per minute, whichever is greater
-----------------------	--

---

Averaging period	1 minute
------------------	----------

---

**Pulse rate**

---

---

**EarlySense specifications**

---

Unit of measure	beats per minute
Measurement range	30 to 170 beats per minute <sup>1</sup>
Accuracy <sup>2</sup>	±4% or ±5 beats per minute, whichever is greater
Averaging period	1 minute

<sup>1</sup> The system detects pulse rate that is > 1.8 times the respiration rate.

<sup>2</sup> Total system accuracy including undetected signals equals 90%.

---

**ECG specifications**



---

**Module**

Length	101.6 mm (4.00 in.)
Width	57.15 mm (2.25 in.)
Height	27.94 mm (1.10 in.)
Weight	73.71 g (2.60 oz.)
Protection against the ingress of water	IPX0 = No protection against water ingress.
Device classification	
EMC Class	Class IIB
IEC Type	Type CF
Heart rate detection range	20 to 300 beats per minute
Heart rate accuracy	±3 beats per minute or ±3%, whichever is greater
QRS detection amplitude	≥ 0.3 mV and ≤ 5.0 mV with QRS width of between 40 ms and 120 ms
Tall T wave rejection	Rejects Tall T waves less than 1.4 mV
Heart rate meter accuracy and response to irregular rhythm	The Heart Rate shall stabilize within 20 seconds and report the following Heart Rates for data sets A.1 to A.4 with accuracy of ± 5 BPM: A.1 Ventricular bigeminy 80 BPM A.2 Slow alternating ventricular bigeminy 60 BPM A.3 Rapid alternating ventricular bigeminy 120 BPM A.4 Bidirectional systoles 90 BPM

---

**ECG specifications**

Response time of heart rate meter to change in heart rate	Increasing from 80 to 120 beats/minute: 10 sec Decreasing from 80 to 40 beats/minute: 10 sec
Time to alarm for tachycardia	Waveform B1 Amplitude – Average time to alarm: <ul style="list-style-type: none"> <li>• 0.5 mV – 10 seconds</li> <li>• 1.0 mV – 10 seconds</li> <li>• 2.0 mV – 10 seconds</li> </ul> Waveform B2 Amplitude – Average time to alarm: <ul style="list-style-type: none"> <li>• 1.0 mV – 10 seconds</li> <li>• 2.0 mV – 10 seconds</li> <li>• 4.0 mV – 10 seconds</li> </ul>
Data storage capacity	24 hours
Pacemaker detection	±2 mV to ±700 mV amplitude; 0.5 ms to 2.0 ms pulse width per EN 60601-2-27: 2011. Rejects pacemaker signals, including double-paced signals, with over/undershoot with the exception of pacemaker signals having an overshoot with a time constant from 4 ms to 100 ms.
	 <b>NOTE</b> For leads I, II, III only. The module does not detect or display pacemaker pulses on lead V.
A/D bit resolution	0.5 µV
Dynamic range	±300 mV (95% gain accuracy)
Sampling rate	250 ±2% samples per second
Sweep speed	25 mm/sec, 50 mm/sec
Mains filter	50 Hz, 60 Hz, off (default = 60 Hz)
Frequency range	0.5 to 70 Hz
Power source	USB (4.5 V to 5.5 V)
Digital data interface	Serial (USB – Full Speed)
Monitoring period	Continuous
ECG channels	Supports 3-lead or 5-lead
Resolution	14 bit ECG data, 30 mV peak-to-peak dynamic range minimum

**ECG specifications**

Lead-off detection	3-lead or 5-lead
Applied currents	Lead connection failures are detected by a bias current with respect to the reference electrode.
User-adjustable parameters	See Alarms

**ECG cable specifications**

Connector at ECG module	80 in. ± 1 shielded cable to a 24 in. ± 1 lead fan-out to electrode connection
ECG cables	3-lead or 5-lead to snap connection
Patient cables	Conforms to ANSI/AAMI EC53

**Impedance respiration specifications**

Impedance Respiration accuracy	±2 breaths per minute or ±2%, whichever is greater
Range	5 to 100 breaths per minute
Breath detection range	0.4 ohms to 3.0 ohms
Respiration lead source	Lead II (right arm and left leg)
Respiration, leads-off sensing and active noise suppression (applied currents)	Respiration – Excitation signal characteristics Less than 25 uA RMS at 31 kHz pseudo sine wave Lead off – DC current of 50nA max for RA ,LA, LL, V; 200nA max for RL Noise suppression – DC current of 200nA max for RL

<b>Alarm limits</b>	<b>Upper limit range of entry</b>	<b>Lower limit range of entry</b>
Systolic	Adult: 30 to 258 mmHg (4.0 to 34.4 kPa). Factory default: 220 mmHg (29.3 kPa).  Pediatric: 32 to 160 mmHg (4.3 to 21.3 kPa). Factory default: 145 mmHg (19.3 kPa).  Neonate: 27 to 120 mmHg (3.6 to 16.0 kPa). Factory default: 100 mmHg (13.3 kPa).	Adult: 28 to 256 mmHg (3.7 to 34.1 kPa). Factory default: 75 mmHg (10.0 kPa).  Pediatric: 30 to 158 mmHg (4.0 to 21.1 kPa). Factory default: 75 mmHg (10.0 kPa).  Neonate: 25 to 118 mmHg (3.3 to 15.7 kPa). Factory default: 50 mmHg (6.7 kPa).
Diastolic	Adult: 22 to 235 mmHg (2.9 to 31.3 kPa). Factory default: 110 mmHg (14.7 kPa).  Pediatric: 17 to 130 mmHg (2.3 to 17.3 kPa). Factory default: 100 mmHg (13.3 kPa).  Neonate: 12 to 105 mmHg (1.6 to 14.0 kPa). Factory default: 70 mmHg (9.3 kPa).	Adult: 20 to 233 mmHg (2.7 to 31.1 kPa). Factory default: 35 mmHg (4.7 kPa).  Pediatric: 15 to 128 mmHg (2.0 to 17.1 kPa). Factory default: 35 mmHg (4.7 kPa).  Neonate: 10 to 103 mmHg (1.3 to 13.7 kPa). Factory default: 30 mmHg (4.0 kPa).

<b>Alarm limits</b>	<b>Upper limit range of entry</b>	<b>Lower limit range of entry</b>
MAP	<p>Adult: 22 to 255 mmHg (2.9 to 34.0 kPa). Factory default: 120 mmHg (16.0 kPa).</p> <p>Pediatric: 17 to 140 mmHg (2.3 to 18.7 kPa). Factory default: 110 mmHg (14.7 kPa).</p> <p>Neonate: 12 to 110 mmHg (1.6 to 14.7 kPa). Factory default: 80 mmHg (10.7 kPa).</p>	<p>Adult: 20 to 253 mmHg (2.7 to 33.7 kPa). Factory default: 50 mmHg (6.7 kPa).</p> <p>Pediatric: 15 to 138 mmHg (2.0 to 18.4 kPa). Factory default: 50 mmHg (6.7 kPa).</p> <p>Neonate: 10 to 108 mmHg (1.3 to 14.4 kPa). Factory default: 35 mmHg (4.7 kPa).</p>
SpO <sub>2</sub>	<p>Adult, Pediatric, Neonate: 52% to 100%. Factory default: 100%.</p>	<p>Adult, Pediatric, Neonate: 50% to 98%. Factory default: 90%.</p>
SpHb	<p>Adult, Pediatric, Neonate: 1.5 to 24.5 g/dL (1.5 to 15.0 mmol/L). Factory default: 17.0 g/ dL (11.0 mmol/L).</p>	<p>Adult, Pediatric, Neonate: 1.0 to 24.0 g/dL (1.0 to 14.5 mmol/L). Factory default: 7.0 g/ dL (4.0 mmol/L).</p>
Pulse rate (NIBP, SpO <sub>2</sub> )	<p>Adult: 27 to 300 beats per minute. Factory default: 120 beats per minute.</p> <p>Pediatric: 27 to 300 beats per minute. Factory default: 150 beats per minute.</p> <p>Neonate: 27 to 300 beats per minute. Factory default: 200 beats per minute.</p>	<p>Adult: 25 to 298 beats per minute. Factory default: 50 beats per minute.</p> <p>Pediatric: 25 to 298 beats per minute. Factory default: 50 beats per minute.</p> <p>Neonate: 25 to 298 beats per minute. Factory default: 100 beats per minute.</p>
Pulse rate (EarlySense)	<p>Adult, Pediatric: 37 to 150 beats per minute. Factory default: 130 beats per minute.</p>	<p>Adult: 35 to 148 beats per minute. Factory default: 40 beats per minute.</p>
Temperature	<p>Adult, Pediatric, Neonate: 87.1 to 110.0°F (30.6 to 43.3°C). Factory default: 101.0°F (38.3°C).</p>	<p>Adult, Pediatric, Neonate: 85.1 to 108.0°F (29.5 to 42.2°C). Factory default: 94.0°F (34.4°C).</p>
etCO <sub>2</sub>	<p>Adult: 2 to 150 mmHg (0.3 to 20.0 kPa). Factory default: 60 mmHg (8.0 kPa).</p> <p>Pediatric: 2 to 150 mmHg (0.3 to 20.0 kPa). Factory default: 60 mmHg (8.0 kPa).</p> <p>Neonate: 2 to 150 mmHg (0.3 to 20.0 kPa). Factory default: 50 mmHg (6.7 kPa).</p>	<p>Adult: 0 to 148 mmHg (0.0 to 19.7 kPa). Factory default: 15 mmHg (2.0 kPa).</p> <p>Pediatric: 0 to 148 mmHg (0.0 to 19.7 kPa). Factory default: 15 mmHg (2.0 kPa).</p> <p>Neonate: 0 to 148 mmHg (0.0 to 19.7 kPa). Factory default: 20 mmHg (2.7 kPa).</p>
FiCO <sub>2</sub>	<p>Adult: 0 to 150 mmHg (0.0 to 20.0 kPa). Factory default: 8 mmHg (1.1 kPa).</p> <p>Pediatric: 0 to 150 mmHg (0.0 to 20.0 kPa). Factory default: 8 mmHg (1.1 kPa).</p> <p>Neonate: 0 to 150 mmHg (0.0 to 20.0 kPa). Factory default: 5 mmHg (0.7 kPa).</p>	<p>None</p>
IPI	<p>None</p>	<p>Adult, Pediatric: 1 to 10. Factory default: 4.</p>
RR (CO <sub>2</sub> )	<p>Adult: 5 to 150 breaths per minute. Factory default: 50 breaths per minute.</p> <p>Pediatric: 5 to 150 breaths per minute. Factory default: 50 breaths per minute.</p>	<p>Adult: 0 to 145 breaths per minute. Factory default: 3 breaths per minute.</p> <p>Pediatric: 0 to 145 breaths per minute. Factory default: 3 breaths per minute.</p>

Alarm limits	Upper limit range of entry	Lower limit range of entry
	Neonate: 5 to 150 breaths per minute. Factory default: 80 breaths per minute.	Neonate: 0 to 145 breaths per minute. Factory default: 12 breaths per minute.
RR (EarlySense)	Adult, Pediatric: 9 to 44 breaths per minute. Factory default: 32 breaths per minute.	Adult, Pediatric: 8 to 43 breaths per minute. Factory default: 8 breaths per minute.
RRa	Adult: 5 to 150 breaths per minute. Factory default: 50 breaths per minute.	Adult: 0 to 145 breaths per minute. Factory default: 3 breaths per minute.
Patient movement	Exit sensitivity: 1 to 6. Factory default: 3 EH > 1 minute	Off

## Alarm delays

Physiological parameter	Default delay (seconds)	Configurable range (seconds) <sup>1</sup>	Sum of default delays (seconds) <sup>2</sup>	Sum of configurable delays (seconds)
<b>Pulse rate</b>				
SpO2	3	3–120	4	4–121
Motion (EarlySense)	3	3–120	4	4–121
ECG	Off	0–120	1	1–121
<b>SpO2</b>	10	0–30	11	1–31
<b>SpHb</b>	10	0–10	11	1–11
<b>etCO2</b>	15	0–30	16	1–31
<b>etCO2 no breath detected</b>	Adult: 30	10–60	31	11–61
	Pediatric: 20	10–60	21	11–61
	Neonate: 15	10–60	16	11–61
<b>Motion low confidence RR/PR alarm delay</b>	180	180–1800	181	181–1801
<b>Respiration rate</b>				
RRa (Masimo)	10	0–60	11	1–61
CO2	10	0–60	11	1–61
ECG	10	0–60	11	1–61

Physiological parameter	Default delay (seconds)	Configurable range (seconds) <sup>1</sup>	Sum of default delays (seconds) <sup>2</sup>	Sum of configurable delays (seconds)
Motion (EarlySense)	180	10–180	181	11–181

<sup>1</sup>These delays are configurable in Advanced settings.

<sup>2</sup>When the device determines the alarm condition, it generates alarm signals (visual and auditory) and notifies any system to which it is connected within one second.



**NOTE** The maximum alarm signal generation delay of a technical alarm when connected to a central station is 4 seconds.



**NOTE** There are no inherent alarm condition delays in the system for temperature or blood pressure alarms.

Consider ALL of these alarm delays when setting up your monitor and remote alarm system.

## ECG software and alarm specifications

Characteristic	Specification
Ventricular tachycardia threshold default	120 beats per minute ±3 beats per minute for 6 consecutive beats
Variable ventricular tachycardia settings	100 beats per minute to 150 beats per minute ±3 beats per minute for 6 consecutive beats
Asystole threshold default	No detectable beat for greater than 4 seconds
Ventricular fibrillation threshold default	A fibrillatory waveform persisting for greater than 4 seconds
Configurable mains filter	ON or OFF; 50 Hz or 60 Hz
Data stream bytes output	Maximum latency < 100 ms
Tall T wave rejection per IEC 60601-2-27:2011 clause 201.12.1.101.17	Rejects Tall T waves through 1.4 mV
Heart rate averaging method per IEC 60601-2-27:2011 Clause 201.7.9.2.9.101	Number of consecutively detected beats: >10: Heart rate = 60/(average of last 10 detected consecutive R-R intervals) > 2 and <10 : Heart rate = 60/(average of the detected consecutive R-R intervals)
Response to change in Heart rate per IEC 60601-2- 27:2011 Clause 201.7.9.2.9.101	Increasing from 80 to 120 beats per minute: 6.0 sec Decreasing from 80 to 40 beats per minute: 16.0 sec

## Protection against defibrillation

Defibrillation protection per EN60601-2-27:2011. ECG device will resume according to the table below.

Parameter	Initial report after defibrillation	Maximum time to recover	Note
HR value	Acquiring	3 sec +5 beats	Depends on patient heart rate
ECG waveform	Waveform	≤ 5 sec	
Respiration value	Acquiring	3 sec +5 breaths	Depends on patient respiration rate
Pacer detect	Pacer marker in waveform	≤ 5 sec	
Arrhythmia	Acquiring or Cannot analyze	5 sec +5 beats	Depends on patient heart rate

## Protection against electrosurgical

Electrosurgical protection per EN60601-2-27:2011. ECG device will resume as per the table below.

Parameter	Initial report after defibrillation	Maximum time to recover	Note
HR value	Acquiring	10 sec +5 beats	Depends on patient heart rate
ECG waveform	Waveform	≤ 10 sec	
Respiration value	Acquiring	10 sec +5 breaths	Depends on patient respiration rate
Pacer detect	Pacer marker in waveform	≤ 10 sec	
Arrhythmia	Acquiring or Cannot analyze	10 sec +5 beats	Depends on patient heart rate

## Device classification

ECG device will operate per table below after startup and after changes to parameter configurations (e.g., filter on/off) or lead off recovery.

Parameter	Initial report after defibrillation	Maximum time to recover	Note
-----------	-------------------------------------	-------------------------	------



Parameter	Initial report after defibrillation	Maximum time to recover	Note
HR value	Acquiring	10 sec +5 beats	Depends on patient heart rate
ECG waveform	Waveform	≤ 3 sec	
Respiration value	Acquiring	10 sec +5 breaths	Depends on patient respiration rate
Pacer detect	Pacer marker in waveform	≤ 3 sec	
Arrhythmia	Acquiring or Cannot analyze	10 sec +5 beats	Depends on patient heart rate

## Environmental specifications

Operating temperature	50 °F to 104 °F (10 °C to 40 °C)
Transport/storage temperature	-4 °F to 122 °F (-20 °C to 50 °C)
Operating altitude	-557 to 10,000 ft. (-170 m to 3,048 m)
Operating humidity	15 to 95% noncondensing
Transport/storage humidity	15% to 95% noncondensing

## Device radio

The device's radio operates on 802.11 networks. For information regarding the configuration of network connections and recommended settings, see the "*Wireless Best Practices Overview*" at <https://www.hillrom.com/content/dam/hillrom-aem/us/en/sap-documents/LIT/80023/80023689LITPDF.pdf>.

<b>Wireless network interface</b>	IEEE 802.11 a/b/g/n	
<b>Frequency</b>	<b>2.4 GHz frequency bands</b>	<b>5 GHz frequency bands</b>
	2.4 GHz to 2.483 GHz	5.15 GHz to 5.35 GHz, 5.725 GHz to 5.825GHz
<b>Channels</b>	<b>2.4 GHz channels</b>	<b>5 GHz</b>
	Up to 14 (3 non-overlapping); country-dependent	Up to 23 non overlapping; country-dependent
<b>Authentication/Encryption</b>	Wireless Equivalent Privacy (WEP, RC4 Algorithm); Wi-Fi Protected Access (WPA); IEEE 802.11i (WPA2); TKIP, RC4 Algorithm; AES, Rijndael Algorithm; Encryption Key	

Provisioning; Static (40-bit and 128-bit lengths); PSK; Dynamic; EAP-FAST; EAP-TLS; EAP-TTLS; PEAP-GTC <sup>1</sup> PEAP-MSCHAPv2; PEAP-TLS;

<b>Antenna</b>	Ethertronics WLAN_1000146
<b>Wireless data rates</b>	802.11a (OFDM): 6, 9, 12, 18, 24, 36, 48, 54 Mbps
	802.11b (DSSS, CCK): 1, 2, 5.5, 11 Mbps
	802.11g (OFDM): 6, 9, 12, 18, 24, 36, 48, 54 Mbps
	802.11n (OFDM, HT20, MCS 0-7): 6.5, 13, 19.5, 26, 39, 52, 58.5, 72.2 Mbps
<b>Protocols</b>	UDP, DHCP, TCP/IP
<b>Data transfer protocols</b>	UDP/TCP/IP
<b>Output power</b>	39.81 mW typical, country-dependent
<b>Ancillary IEEE standards</b>	802.11d, 802.11e, 802.11h, 802.11i, 802.11X
<sup>1</sup> One-time passwords are not supported.	
<b>Wireless network interface</b>	IEEE 802.11 b/g, 802.11a
<b>Frequency</b>	802.11 b/g: 2.402 GHz to 2.4835 GHz 802.11a: 5.125 GHz to 5.875 GHz
<b>Channels</b>	Up to 14 in 802.11b/g, up to 24 in 802.11a; country-dependent
<b>Security/encryption/authentication</b>	WPA2/AES (either EAP or PSK authentication)
<b>Antenna</b>	Internal multiband PIFA
<b>Wireless data rates</b>	802.11b: 1 Mbps or higher during vitals transmission only 802.11a/g: 6 Mbps or higher during vitals transmission only (approximately 2 seconds per reading)
<b>Protocols</b>	UDP, DHCP, TCP/IP
<b>Data transfer protocols</b>	UDP, TCP/IP
<b>Modulation</b>	OFDM (802.11a/g), DSSS/CCK (802.11b)
<b>Output power</b>	40 mW typical, country-dependent
<b>Ancillary IEEE standards</b>	802.11e, 802.11h, 802.11i, 802.11X

## Configuration options

### Vital Signs Monitor 6000 Series

The monitor is available in multiple configurations.

**Monitors capable of supporting a combination of CO<sub>2</sub>/RR or RRa or EarlySense (patient movement), NIBP, SpO<sub>2</sub>, SpHb, pulse rate, ECG, and temperature**

Model	Description
6700	Standard. Includes nurse call, Ethernet, and USB connectivity. The radio is optional.
6800	Wireless. Includes all Standard features plus an internal 802.11 a/b/g radio.

### Integrated Wall System

The wall system is available in the following configurations.

Model Prefix	Description
84 series	Standard. Includes nurse call, Ethernet, and USB connectivity.
85 series	Wireless. Includes all Standard features plus an internal 802.11 a/b/g radio.



# Standards and compliance

---

## General compliance and standards

The monitor complies with the following standards<sup>1</sup>:

IEC 60601-1

IEC 60601-1-2

IEC 60601-1-6

IEC 60601-1-8

IEC 60601-2-27<sup>2</sup>

IEC 80601-2-30

IEC 80601-2-49

ISO 80601-2-55

ISO 80601-2-56

ISO 80601-2-61

ISO 10993

IEC 62304

IEC 62366-1

---

<sup>1</sup> Standards are essentially the IEC 60601-1 series of standards plus the listed country's National Deviations (e.g., AS/NZ, CAN/CSA, EN Harmonized version, etc.).

<sup>2</sup> Alarms might display and sound during an Electrosurgery Interference event.

---



**Directive 2012/19/EU-WEEE:  
Disposal of noncontaminated electrical and electronic equipment**

This product and its accessories must be disposed of according to local laws and regulations. Do not dispose of this product as unsorted municipal waste. Prepare this product for reuse or separate collection as specified by Directive 2012/19/EU of the European Parliament and the Council of the European Union on Waste Electronic and Electrical Equipment (WEEE). If this product is contaminated, this directive does not apply.

For more specific disposal or compliance information, see [www.welchallyn.com/weee](http://www.welchallyn.com/weee), or contact Hillrom Technical Support: [hillrom.com/en-us/about-us/locations](http://hillrom.com/en-us/about-us/locations).

## General radio compliance

The wireless features of this monitor must be used in strict accordance with the manufacturer's instructions as described in the user documentation that comes with the product.

This device complies with Part 15 of the FCC rules and with the rules of the Canadian ICES-003 as described below.

## Federal Communications Commission (FCC)

This device complies with part 15 of the FCC Rules. Operation is subject to the following two conditions:

- This device may not cause harmful interference.
- This device must accept any interference received, including interference that may cause undesired operation.

This equipment has been tested and found to comply with the limits for a Class B digital device, pursuant to Part 15 of FCC Rules. These limits are designed to provide reasonable protection against harmful interference in a residential installation. This equipment generates, uses, and can radiate radio frequency energy. If not installed and used in accordance with the instructions, it may cause harmful interference to radio communications. However, there is no guarantee that interference will not occur in a particular installation. If this equipment does cause harmful interference to radio or television reception, which can be determined by turning the equipment off and on, the user is encouraged to try and correct the interference by one or more of the following measures:

- Reorient or relocate the receiving antenna
- Increase the distance between the equipment and the receiver
- Connect the equipment to an outlet on a circuit different from that to which the receiver is connected
- Consult the dealer or an experienced radio/TV technician for help

The user may find the following booklet prepared by the Federal Communications Commission helpful:

*The Interference Handbook*

This booklet is available from the U.S. Government Printing Office, Washington, D.C. 20402. Stock No. 004-000-0034504.

Welch Allyn is not responsible for any radio or television interference caused by unauthorized modification of the devices included with this Welch Allyn product, or the substitution or attachment of connecting cables and equipment other than specified by Welch Allyn.



The correction of interference caused by such unauthorized modification, substitution, or attachment will be the responsibility of the user.

## Radio compliance/approvals

### Newmar radio

This table applies only to devices with a Newmar radio card installed. Distinguishing features of devices with this radio card are the following:

- In Advanced settings, the Session frame on the **Network > Status** tab includes **Tx packets dropped, Rx packets dropped, and Rx multicast packets.**
- In Advanced settings, the left pane on the **Network > Radio** tab includes an *Enable dynamic frequency* option.

<b>US</b>	SQG-WB45NBT FCC Part 15.247 Subpart C, FCC Part 15.407 Subpart E	
<b>Europe</b>	2014/53/EU Radio Equipment Directive	
<b>Canada</b>	(IC) RSS-210 standard. IC 3147A-WB45NBT based on FCC testing	
<b>Australia and New Zealand</b>	Australian Communications and Media Authority (ACMA) Radio Compliance Mark  (RCM) New Zealand maintains a Mutual Recognition Agreement (MRA) with Australia.	
<b>Brazil</b>	Este equipamento opera em caráter secundário, isto é, não tem direito a proteção contra interferência prejudicial, mesmo de estações do mesmo tipo, e não pode causar interferência a sistemas operando em caráter primário.	 ANATEL Model No. 05725-17-10188
<b>Mexico</b>	Instituto Federal de Telecomunicaciones (Federal Telecommunications Institute—IFETEL)	This product contains an Approved module, Model No. WB45NBT IFETEL No. RCPLAWB14-2006
<b>Singapore</b>	Infocomm Development Authority of Singapore (IDA) (新加坡资讯通信发展管理局)	This product contains an IDA approved device.
<b>South Africa</b>	Independent Communications Authority of South Africa	This product contains an ICASA-approved device.  TA-2016/2122

<b>South Korea</b>	Korea Communications Commission (대한민국 방송통신위원회) - KCC		This device complies with Article 58-2 Radio Waves Act of Korea Communications Commission. This equipment is Industrial (Class A) electromagnetic wave suitability equipment and seller or user should take notice of it, and this equipment is to be used in the places except for home.
	Certification number: MSIP-CRM-LAI-WB45NBT		
	Class A Equipment (Industrial Broadcasting & Communication Equipment) A 급 기기 (업무용 방송통신기자재)	이 기기는 업무용 (A 급) 전자파적합 기기로서 판매자 또는 사용자는 이 점을 주의하시기 바라며, 가정외의 지역에서 사용하는 것을 목적으로 합니다.	

To ensure compliance with local regulations, be sure the correct country in which the access point is installed is selected. This product can be used with the following restriction(s):

Norway - Does not apply for the geographical area within a radius of 20 km from the center of Ny-Ålesund.

France - Outdoor use is limited to 10 mW EIRP within the band 2454 to 2483.5 MHz.



**NOTE** Effective Isotropic Radiated Power (EIRP).



**NOTE** Some countries restrict the use of 5-GHz bands. The 802.11a radio in the device uses only the channels indicated by the access point with which the radio associates. The hospital IT department must configure access points to operate with approved domains.



## Lamarr radio

This table applies only to devices with a Lamarr radio card installed. Distinguishing features of devices with this radio card are the following:

- In Advanced settings, the Session frame on the **Network > Status** tab includes **Dir. Rx packets**, **Dir. Tx packets**, and **Signal-to-noise ratio**.
- In Advanced settings, the left pane on the **Network > Radio** tab includes only *Enable radio* and *Enable radio network alarms* options (no *Enable dynamic frequency* option).

<b>US</b>	PGUWA11ABG09 FCC Part 15.247 Subpart C, FCC Part 15.407 Subpart E
<b>Europe</b>	2014/53/EU Radio Equipment Directive
<b>Canada</b>	(IC) RSS-210 standard. IC 4168A-WA11ABG09 based on FCC testing
<b>Australia and New Zealand</b>	 <p>Australian Communications and Media Authority (ACMA) Radio Compliance Mark (RCM)</p> <p>New Zealand maintains a Mutual Recognition Agreement (MRA) with Australia.</p>
<b>Argentina</b>	Autoridad Federal de las Tecnologías Contiene Modulo CNC I.D. C-10142



	de la Informacion y las Comunicaciones (AFTIC)		
Brazil	Agência Nacional de Telecomunicações (ANATEL)  ANATEL Model No. 05725-17-10188	“Este equipamento opera em caráter secundário, isto é, não tem direito a proteção contra interferência prejudicial, mesmo de estações do mesmo tipo, e não pode causar interferência a sistemas operando em caráter primário.”	
Mexico	Instituto Federal de Telecomunicaciones (Federal Telecommunications Institute—IFETEL)	This product contains an Approved module, Model No. Welch Allyn 802. 11a/b/g, IFETEL No. RCPWEWE10-0521	
Singapore	Infocomm Development Authority of Singapore (IDA) 新加坡资讯通信发展管理局	Singapore: Complies with IDS standard	
South Africa	Independent Communications Authority of South Africa  TA-2010/782	This product contains an ICASA-approved device.	
South Korea	Korea Communications Commission (대한민국 방송통신위원회) - KCC Certification number: KCC-CRM-BVT-WA80211ABG	 Class A Equipment (Industrial Broadcasting & Communication Equipment) A급 기기 (업무용 방송통신기자재)	This equipment is Industrial (Class A) electromagnetic wave suitability equipment and seller or user should take notice of it, and this equipment is to be used in the places except for home. 이 기기는 업무용(A급) 전자파적합기기로서 판매자 또는 사용자는 이 점을 주의하시기 바라 며, 가정외의 지역에서 사용하는 것을 목적으로 합니다.

To ensure compliance with local regulations, be sure the correct country in which the access point is installed is selected. This product can be used with the following restriction(s):

France - Outdoor use is limited to 10 mW EIRP within the band 2454 to 2483.5 MHz.

Norway - Does not apply for the geographical area within a radius of 20 km from the center of Ny-Ålesund.



**NOTE** Effective Isotropic Radiated Power (EIRP).



**NOTE** Some countries restrict the use of 5-GHz bands. The 802.11a radio in the monitor uses only the channels indicated by the access point with which the radio associates. The hospital IT department must configure access points to operate with approved domains.

## Industry Canada (IC) emissions

This device complies with RSS 210 of Industry Canada.

Operation is subject to the following two conditions: (1) this device may not cause interference, and (2) this device must accept any interference, including interference that may cause undesired operation of this device.

L'utilisation de ce dispositif est autorisée seulement aux conditions suivantes: (1) il ne doit pas produire de brouillage et (2) l'utilisateur du dispositif doit être prêt à accepter tout brouillage radioélectrique reçu, même si ce brouillage est susceptible de compromettre le fonctionnement du dispositif.

This Class B digital apparatus complies with Canadian ICES-003.

Cet appareil numérique de la classe B est conforme à la norme NMB-003 du Canada.

## European Union

Czech	Welch Allyn tímto prohlašuje, že tento RLAN device je ve shodě se základními požadavky a dalšími příslušnými ustanoveními směrnice 2014/53/ES.
Danish	Undertegnede Welch Allyn erklærer herved, at følgende udstyr RLAN device overholder de væsentlige krav og øvrige relevante krav i direktiv 2014/53/EF
Dutch	Bij deze verklaart Welch Allyn dat deze RLAN device voldoet aan de essentiële eisen en aan de overige relevante bepalingen van Richtlijn 2014/53/EC.
English	Hereby, Welch Allyn, declares that this RLAN device is in compliance with the essential requirements and other relevant provisions of Directive 2014/53/EC.
Estonian	Käesolevaga kinnitab Welch Allyn seadme RLAN device vastavust direktiivi 2014/53/EÜ põhinõuetele ja nimetatud direktivist tulenevatele teistele asjakohastele sätetele.
Finnish	Welch Allyn vakuuttaa täten että RLAN device tyyppinen laite on direktiivin 2014/53/EY oleellisten vaatimusten ja sitä koskevien direktiivin muiden ehtojen mukainen.
French	Par la présente, Welch Allyn déclare que ce RLAN device est conforme aux exigences essentielles et aux autres dispositions de la directive 2014/53/CE qui lui sont applicables
German	Hiermit erklärt Welch Allyn die Übereinstimmung des Gerätes RLAN device mit den grundlegenden Anforderungen und den anderen relevanten Festlegungen der Richtlinie 2014/53/EG. (Wien)
Greek	ΜΕ ΤΗΝ ΠΑΡΟΥΣΑ Welch Allyn ΔΗΛΩΝΕΙ ΟΤΙ RLAN device ΣΥΜΜΟΡΦΩΝΕΤΑΙ ΠΡΟΣ ΤΙΣ ΟΥΣΙΩΔΕΙΣ ΑΠΑΙΤΗΣΕΙΣ ΚΑΙ ΤΙΣ ΛΟΙΠΕΣ ΣΧΕΤΙΚΕΣ ΔΙΑΤΑΞΕΙΣ ΤΗΣ ΟΔΗΓΙΑΣ 2014/53/ΕΚ
Hungarian	Alulírott, Welch Allyn nyilatkozom, hogy a RLAN device megfelel a vonatkozó alapvető követelményeknek és az 2014/53/EC irányelv egyéb előírásainak.

---

Italian	Con la presente Welch Allyn dichiara che questo RLAN device è conforme ai requisiti essenziali ed alle altre disposizioni pertinenti stabilite dalla direttiva 2014/53/CE.
Latvian	Ar šo Welch Allyn deklarē, ka RLAN device atbilst Direktīvas 2014/53/EK būtiskajām prasībām un citiem ar to saistītajiem noteikumiem.
Lithuanian	Šiuo Welch Allyn deklaruoja, kad šis RLAN device atitinka esminius reikalavimus ir kitas 2014/53/EB Direktyvos nuostatas.
Malti	Hawnhekk, Welch Allyn, jiddikjara li dan RLAN device jikkonforma mal-htigijiet essenzjali u ma provvedimenti ohrajn relevanti li hemm fid-Direttiva 2014/53/EC
Portuguese	Welch Allyn declara que este RLAN device está conforme com os requisitos essenciais e outras disposições da Directiva 2014/53/CE.
Slovak	Welch Allyn týmto vyhlasuje, ze RLAN device spĺňa základné požiadavky a všetky príslušné ustanovenia Smernice 2014/53/ES.
Slovene	Šiuo Welch Allyn deklaruoja, kad šis RLAN device atitinka esminius reikalavimus ir kitas 2014/53/EB Direktyvos nuostatas.
Spanish	Por medio de la presente Welch Allyn declara que el RLAN device cumple con los requisitos esenciales y cualesquiera otras disposiciones aplicables o exigibles de la Directiva 2014/53/CE
Swedish	Härmed intygar Welch Allyn att denna RLAN device står i överensstämmelse med de väsentliga egenskapskrav och övriga relevanta bestämmelser som framgår av direktiv 2014/53/EG.

---



# Guidance and manufacturer's declaration

## EMC compliance

Special precautions concerning electromagnetic compatibility (EMC) must be taken for all medical electrical equipment. This device complies with IEC 60601-1-2:2014/EN 60601-2-1:2015.

- All medical electrical equipment must be installed and put into service in accordance with the EMC information provided in this *Instructions for use*.
- Portable and mobile RF communications equipment can affect the behavior of medical electrical equipment.

The monitor complies with all applicable and required standards for electromagnetic interference.

- It does not normally affect nearby equipment and devices.
- It is not normally affected by nearby equipment and devices.
- It is not safe to operate the monitor in the presence of high-frequency surgical equipment.
- However, it is good practice to avoid using the monitor in extremely close proximity to other equipment.



**NOTE** The monitor has essential performance requirements associated with blood pressure measurement, oxygen saturation, and temperature measurement. In the presence of EM disturbances, the device will display an error code. Once the EM disturbances stop the monitor will self-recover and perform as intended.



**NOTE** The emissions characteristics of this equipment make it suitable for use in industrial areas and hospitals (CISPR 11 class A). If it is used in a residential environment (for which CISPR 11 class B is normally required) this equipment might not offer adequate protection to radio-frequency communication services. The user might need to take mitigation measures, such as relocating or re-orienting the equipment.



**WARNING** The use of the monitor adjacent to or stacked with other equipment or medical electrical systems should be avoided because it could result in improper operation. If such use is necessary, the monitor and other equipment should be observed to verify that they are operating normally.



**WARNING** Use only Accessories recommended by Welch Allyn for use with the monitor. Accessories not recommend by Welch Allyn may affect the EMC emissions or immunity.



**WARNING** Maintain minimum separation distance of 12 inches (30 cm) between any part of the monitor and portable RF communication equipment (including peripherals such as antenna cables and external antennas). Performance of the monitor may be degraded if proper distance is not maintained.

## Emissions and immunity information

For information about electromagnetic compatibility (EMC), see the Hillrom website:

<https://www.hillrom.com/en/knowledge/resources/emc-compliance/#CVSMCIWS>

You can order a printed copy of the Emissions and immunity information from Welch Allyn for delivery within 7 calendar days.

## Appendix

---

### Approved accessories

The following tables list approved monitor and wall system accessories and documentation. For information about options, upgrades, and licenses, refer to the service manual.

#### FlexiPort cuffs (not made with natural rubber latex)

Part Number	Model	Description
Reuse-08-2MQ	Reusable	Cuff, reuse, SM CHILD, 2-tube, MQ
Reuse-09-2MQ	Reusable	Cuff, reuse, CHILD, 2-tube, MQ
Reuse-10-2MQ	Reusable	Cuff, reuse, SM AD, 2-tube, MQ
Reuse-11-2MQ	Reusable	Cuff, reuse, ADULT, 2-tube, MQ
Reuse-11L-2MQ	Reusable	Cuff, reuse, AD LONG, 2-tube, MQ
Reuse-12-2MQ	Reusable	Cuff, reuse, LG AD, 2-tube, MQ
Reuse-12L-2MQ	Reusable	Cuff, reuse, LG AD LONG, 2-tube, MQ
Reuse-13-2MQ	Reusable	Cuff, reuse, THIGH, 2-tube, MQ
Neo-1-1	Disposable	Cuff, soft, NEO 1, 1-TUBE, NQ (box of 10)
Neo-2-1	Disposable	Cuff, soft, NEO 2, 1-TUBE, NQ (box of 10)
Neo-3-1	Disposable	Cuff, soft, NEO 3, 1-TUBE, NQ (box of 10)
Neo-4-1	Disposable	Cuff, soft, NEO 4, 1-TUBE, NQ (box of 10)
Neo-5-1	Disposable	Cuff, soft, NEO 5, 1-TUBE, NQ (box of 10)

## Blood pressure accessories (not made with natural rubber latex)

Part Number	Model	Description
4500-30	SureBP	Double tube blood pressure hose (5 ft)
4500-31	SureBP	Double tube blood pressure hose (10 ft)
4500-32	SureBP	Double tube blood pressure hose (8 ft)
6000-30	BP	Single tube blood pressure hose (5 ft)
6000-31	BP	Single tube blood pressure hose (10 ft)
7000-33	BP	Neonatal blood pressure hose (10 ft) with NeoQuik connector

## Masimo pulse oximetry (for use with devices with SpO2)

Masimo RD Set sensors and cables have been tested for biocompatibility in accordance with ISO 10993 and are approved accessories. They are available only from Masimo. To find a Masimo distributor, please refer to [www.masimo.com](http://www.masimo.com).

Part Number	Model	Description
LNCS-DCI	LNCS	Reusable finger sensor - Adult
LNCS-DCIP	LNCS	Reusable finger sensor - Pediatric
LNCS-ADTX	LNCS	Disposable adhesive finger sensor - Adult (20 per case)
LNCS-PDTX	LNCS	Disposable adhesive finger sensor - Pediatric (20 per case)
RED-LNC-10	LNCS	10-foot cable with sensor connector
LNCS-YI	LNCS	Multisite reusable sensor (1 sensor, 6 adhesive wraps)
LNCS-TC-I	LNCS	Reusable ear sensor
LNCS-Neo-L-3	LNCS	Disposable adhesive finger sensor - Neonate/Adult (20 per case)
Neo-Wrap-RP	LNCS	Replacement wrap for neonatal adhesives (100 per case)
LNCS-Inf-3	LNCS	Disposable adhesive finger sensor - Infant (20 per case)
Inf-Wrap-RP	LNCS	Replacement wrap for infant adhesives (100 per case)
YI-AD	LNCS	Multisite adhesive wrap adult/pediatric/neonatal for YI sensor (100 per case)
YI-FM	LNCS	Multisite foam wrap adult/pediatric/neonatal for YI sensor (12 per case)



## Masimo rainbow set (for use with devices with SpO2 and SpHb)

Part Number	Model	Description
724322	rainbow	DCI SC-400 Adult SpHb sensor and 3-foot cable
104149	rainbow	RC-12, 12-foot extension cable, 20 pin, for M-LNCS sensors

## Masimo RRa

Part Number	Model	Description
104771	rainbow	RAS-125 sensor (box of 10)
104772	rainbow	Patient cable

## Nellcor pulse oximetry

Part Number	Model	Description
DS-100A	OxiMax	Durasensor adult oxygen transducer
DOC-10	OxiMax	Extension cable (10 feet)
D-YS	OxiMax	Dura-Y oxygen transducer (1 sensor, 40 wraps)
D-YSE	OxiMax	Ear clip (use with Dura-Y sensor)
D-YSPD	OxiMax	PediCheck pediatric spot check (use with Dura-Y sensor)
MAX-AI	OxiMax	OxiMax adult sensor (single use, case of 24)
MAX-PI	OxiMax	OxiMax pediatric sensor (single use, case of 24)
MAX-II	OxiMax	OxiMax infant sensor (single use, case of 24)
OXI-A/N	OxiMax	Oxiband adult/neonatal transducer (1 sensor, 50 wraps)
OXI-P/I	OxiMax	Oxiband pediatric/infant transducer (1 sensor, 50 wraps)

## SureTemp Plus thermometry

Part Number	Description
02895-000	Oral probe and well kit (9ft., 2.7M)

Part Number	Description
02895-100	Rectal probe and well kit (9ft., 2.7M)
02894-0000	Oral probe well (blue)
02894-1000	Rectal probe well (red)
05031-101	Disposable probe covers (1,000 covers, packaged 25/box)
05031-110	Disposable probe covers (10,000 covers, packaged 25/box)
01802-110	9600 Plus calibration tester
06138-000	Temperature calibration key

## Braun ThermoScan PRO 6000 thermometer and accessory dock

Part Number	Description
06000-900	Dock with thermometer
106743	Dock without thermometer
106744	Wall mount kit
106745	Mobile stand kit

## EarlySense RR, pulse rate, and patient movement

Part Number	Description
105481	Contact-free sensor
MSH-00033	Metallic plate for beds
MSH-00033A	Metallic plate for beds with .78" length hooks for spring pan bed frames
MSH-00033B	Metallic plate for beds with 1.18" length hooks for spring pan bed frames
AME-00970	Bed sensor wall mount hanger
105637	Pigtail cable

## Oridion CO<sub>2</sub>

Oridion Microstream etCO<sub>2</sub> filter lines (sampling lines) have been tested for biocompatibility in accordance with ISO 10993 and are the only accessories approved by Welch Allyn for CO<sub>2</sub> monitoring. They are available only from [www.medtronic.com](http://www.medtronic.com).

## Physical assessment instruments

Part Number	Description
<b>Otoscopies</b>	
23810	MacroView™ otoscope
23820	MacroView™ otoscope with throat illuminator
23814	MacroView™ otoscope with insufflation bulb
23824	MacroView™ otoscope with throat illuminator and insufflation bulb
238-2	Welch Allyn MacroView™ basic otoscope
238-3	Welch Allyn MacroView™ Plus oto for iEx
25020	Diagnostic otoscope with specula
25021	Diagnostic otoscope with insufflation bulb
250-2	Welch Allyn LED otoscope
20201	Pneumatic otoscope without specula
20200	3.5V pneumatic otoscope with specula
20250	3.5V pneumatic otoscope with 12-diopter lens and specula
20251	Pneumatic otoscope with 12-diopter lens
21700	3.5V operating otoscope with specula
21701	3.5V operating otoscope without specula
<b>Specula and specula dispensers</b>	
52432-CLR-1	2.75 mm LumiView clear ear specula (case)
52432-CLR-2	2.75 mm LumiView clear ear specula (bag)
52432-U	2.75 mm Universal KleenSpec® disposable ear specula (case of 10 bags, 850/bag)
52434-CLR-1	4.25 mm LumiView clear ear specula (case)
52434-CLR-2	4.25 mm LumiView clear ear specula (bag)

<b>Part Number</b>	<b>Description</b>
52434-U	4.25 mm Universal KleenSpec® disposable ear specula (case of 10 bags, 850/bag)
52100-PF	Dispenser (full), large ear specula
52400-PF	Dispenser (full), small ear specula
<b>Ophthalmoscopes</b>	
11810	Panoptic™ ophthalmoscope
11820	Panoptic™ ophthalmoscope with cobalt blue filter and add-on corneal viewing lens
118-2	Welch Allyn Panoptic™ basic ophthalmoscope US
118-2-US	Welch Allyn Panoptic™ basic ophthalmoscope
118-3	Welch Allyn Panoptic™ Plus ophthalmoscope for iEx
118-3-US	Welch Allyn Panoptic™ Plus ophthalmoscope US
11710	Standard ophthalmoscope
11720	Coaxial ophthalmoscope
11720-L	3.5V Coaxial ophthalmoscope with LED
11730	AutoStep® coaxial ophthalmoscope
11735	Prestige coaxial-plus ophthalmoscope
<b>Illuminators</b>	
41100	Finnoff ocular transilluminator
41101	Finnoff ocular transilluminator with cobalt blue filter
43300	Curved all-purpose transilluminator
26535	Nasal illuminator (section only)
26538	Complete nasal illuminator
26035	Bivalve nasal speculum
26038	Bivalve nasal speculum with illuminator
27000	Larynx illuminator
27050	Nasopharynx illuminator
28100	Tongue blade holder

Part Number	Description
<b>Lamps</b>	
03100-LED	LED replacement lamp
06500-LED	LED replacement lamp
04900-LED	LED replacement lamp
03800-LED	LED replacement lamp
03100-U	Halogen replacement lamp
06500-U	Halogen replacement lamp
04900-U	Halogen replacement lamp
03800-U	Halogen replacement lamp

## Mounting options

Part Number	Description
4800-60	Accessory Cable Management (ACM) stand — organized mobile stand with bin, standard housing
4900-60	Accessory Cable Management (ACM) stand — organized mobile stand with bin, extended housing
104645	Mounting plate (bracket), ACM mobile stand, extended housing
	 <b>NOTE</b> Use only with the ACM stand, not the MS2 stand.
4700-60	Economy mobile stand with basket, standard housing
4701-62	Wall mount with basket, standard housing
008-0834-01	GCX wall mount with channel, standard housing
4900-62	GCX wall mount with channel, extended housing
104644	Mounting plate (bracket), GCX wall mount, extended housing

## ECG

Part Number	Description
6000-CBL3I	Patient cable 3L IEC
6000-CBL3A	Patient cable 3L AHA
6000-CBL5I	Patient cable 5L IEC
6000-CBL5A	Patient cable 5L AHA
6000-ECG3I	Module + USB + Patient cable 3L IEC
6000-ECG3A	Module + USB + Patient cable 3L AHA
6000-ECG5I	Module + USB + Patient cable 5L IEC
6000-ECG5A	Module + USB + Patient cable 5L AHA
106512	USB cable for ECG module
6200-11	Electrode pads (30 pads/pack, 20 packs/box)

## Miscellaneous items

Part Number	Description
BATT33	Replacement battery (Connex IWS)
BATT99	9 cell Lithium-ion battery
6000-40	Printer paper (10 per pack)
PWCD-B	Line cord B, North America
PWCD-C	Line cord C, China, 8'
PWCD-D	Line cord D, Canada, 8'
PWCD-K	Line cord K, South Korea, 8'
PWCD-M	Line cord M, Mexico, 8'
PWCD-T	Line cord T, Thailand, 8'
PWCD-W	Line cord W, Taiwan, 8'
PWCD-Z	Line cord Z, Brazil, 8'
PWCD-2	Line cord 2, Europe, 8'

Part Number	Description
PWCD-4	Line cord 4, United Kingdom, 8'
PWCD-6	Line cord 6, Australia/New Zealand, 8'
PWCD-7	Line cord 7, South Africa, 8'
6000-NC	Nurse Call cable
6000-916HS	HS1-M 2D barcode scanner
6000-916HSR	2D barcode scanner/RFID reader
4500-925	Cable for wired connectivity
660-0320-00	Patch cable, 100', RJ45 M/M CAT5E
660-0321-00	Patch cable, 50', RJ45 M/M CAT5E
104384	Patch cable, 25', green
660-0138-00	Patch cable, 5', RJ45 T568B
715270	Box set — packaging — empty
104279	Connex IWS shipping box

## SmartCare services for maintenance and repair, Vital Signs Monitor 6000 Series

### SmartCare protection plans

Part Number	Description
S1-CVSM-PRO-1	CVSM SmartCare Protection 1YR
S1-CVSM-PRO-3	CVSM SmartCare Protection 3YR
S1-CVSM-PRO-PS	CVSM SmartCare Protection 3YR POS

### SmartCare protection plus plans

Part Number	Description
S9-CVSM-PROPLUS-1	CVSM SmartCare Protection Plus 1YR
S9-CVSM-PROPLUS-3	CVSM SmartCare Protection Plus 3YR
S9-CVSM-PROPLUS-PS	CVSM SmartCare Protection Plus 3YR POS

**SmartCare biomed plans**

<b>Part Number</b>	<b>Description</b>
S2-6000	Biomed partnership program, 1 year
S2-6000-2	Biomed partnership program, 2 years
S2-6000-5	Biomed partnership program, 5 years
S2-6000-O2	Biomed partnership program, 1 year, with CO2
S2-6000-O2-2	Biomed partnership program, 2 years, with CO2
S2-6000-O2-5	Biomed partnership program, 5 years, with CO2
S2-6000-ES	Biomed partnership program, 1 year, with ES
S2-6000-ES-2	Biomed partnership program, 2 years, with ES
S2-6000-ES-5	Biomed partnership program, 5 years, with ES

**Other service plans**

<b>Part Number</b>	<b>Description</b>
S1-6000	Comprehensive partnership program, 1 year
S1-6000-2	Comprehensive partnership program, 2 years
S1-6000-2C	Comprehensive partnership program, 2 years, with calibration
S1-6000-5	Comprehensive partnership program, 5 years
S1-6000-5C	Comprehensive partnership program, 5 years, with calibration
S1-6000-O2	Comprehensive partnership program, 1 year, with CO2
S1-6000-O2-2	Comprehensive partnership program, 2 years, with CO2
S1-6000-O2-5	Comprehensive partnership program, 5 years, with CO2
S1-6000-O2-C	Comprehensive partnership program, 1 year, with CO2, with calibration
S1-6000-O2-2C	Comprehensive partnership program, 2 years, with CO2, with calibration
S1-6000-O2-5C	Comprehensive partnership program, 5 years, with CO2, with calibration
S1-6000-ES	Comprehensive partnership program, 1 year, with EarlySense



<b>Part Number</b>	<b>Description</b>
S1-6000-ES-2	Comprehensive partnership program, 2 years, with EarlySense
S1-6000-ES-5	Comprehensive partnership program, 5 years, with EarlySense
S1-6000-ES-C	Comprehensive partnership program, 1 year, with EarlySense and calibration
S1-6000-ES-2C	Comprehensive partnership program, 2 years, with EarlySense and calibration
S1-6000-ES-5C	Comprehensive partnership program, 5 years, with EarlySense and calibration
PRV-ESS	Preventive annual sensor replacement program (selected countries)
PRV-001	Preventive Welch Allyn bench service, per unit (selected countries)
PRV-002	Preventive onsite service, per unit (selected countries)
S4-6000	CVSM, Warranty extension, 1 year (selected countries)
S4-6000-2	CVSM, Warranty extension, 2 years (selected countries)
S4-6000-5	CVSM, Warranty extension, 5 years (selected countries)
S4-6000-O2	CVSM with CO2, Warranty extension, 1 year (selected countries)
S4-6000-O2-2	CVSM with CO2, Warranty extension, 2 years (selected countries)
S4-6000-O2-5	CVSM with CO2, Warranty extension, 5 years (selected countries)
S4-6000-ES	CVSM with EarlySense, Warranty extension, 1 year (selected countries)
S4-6000-ES-2	CVSM with EarlySense, Warranty extension, 2 years (selected countries)
S4-6000-ES-5	CVSM with EarlySense, Warranty extension, 5 years (selected countries)

## SmartCare services for maintenance and repair, Integrated Wall System

### SmartCare protection plans

Part Number	Description
S1-CIWS-PRO-1	CIWS SmartCare Protection 1YR
S1-CIWS-PRO-3	CIWS SmartCare Protection 3YR
S1-CIWS-PRO-PS	CIWS SmartCare Protection 3YR POS

### SmartCare protection plus plans

Part Number	Description
S9-CIWS-PROPLUS-1	CIWS SmartCare Protection Plus 1YR
S9-CIWS-PROPLUS-3	CIWS SmartCare Protection Plus 3YR
S9-CIWS-PROPLUS-PS	CIWS SmartCare Protection Plus 3YR POS

### SmartCare biomed plans, Integrated Wall System

Part Number	Description
S2-CIWS	One-year Biomed Partnership Program
S2-CIWS-2	Two-year Biomed Partnership Program
S2-CIWS-5	Five-year Biomed Partnership Program

### Other service plans

Part Number	Description
103371	Barcode license

### Partnership Programs for Global Use

S1-CIWS	One-year Comprehensive Partnership Program
S1-CIWS-2	Two-year Comprehensive Partnership Program

### Technical Training

CIWSSERREPW-TRN	Technical online training for Biomed
-----------------	--------------------------------------

<b>Part Number</b>	<b>Description</b>
CIWSSERREP-TRN	Technical onsite training for Biomed
<b>International Only</b>	
PRV-001	Preventive SVC WA bench per unit
PRV-002	Preventive SVC planned onsite per unit
S4-CIWS	One-year Extended Warranty
S4-CIWS-2	Two-year Extended Warranty
S4-CIWS-5	Five-year Extended Warranty

## Literature/Documentation

<b>Part Number</b>	<b>Description</b>
108093	Connex Devices CD, Instructions for Use, Quick Reference, Multi-language
4600-90E	Blood Pressure Accuracy and Variability Card-English

## Warranty

### Vital Signs Monitor 6000 Series

Welch Allyn warrants the product to be free of defects in material and workmanship and to perform in accordance with manufacturer's specifications for the period of two years from the date of purchase from Welch Allyn or its authorized distributors or agents.

The warranty period shall start on the date of purchase. The date of purchase is: 1) the invoiced ship date if the device was purchased directly from Welch Allyn, 2) the date specified during product registration, 3) the date of purchase of the product from a Welch Allyn authorized distributor as documented from a receipt from said distributor.

This warranty does not cover damage caused by 1) handling during shipping, 2) use or maintenance contrary to labeled instructions, 3) alteration or repair by anyone not authorized by Welch Allyn, and 4) accidents.

The product warranty is also subject to the following terms and limitations: Accessories are not covered by the warranty. Refer to the instructions for use provided with individual accessories for warranty information.

Shipping cost to return a device to a Welch Allyn Service center is not included.

A service notification number must be obtained from Welch Allyn prior to returning any products or accessories to Welch Allyn's designated service centers for repair. To obtain a service notification number, contact Welch Allyn Technical Support.

THIS WARRANTY IS IN LIEU OF ALL OTHER WARRANTIES, EXPRESS OR IMPLIED, INCLUDING BUT NOT LIMITED TO THE IMPLIED WARRANTIES OF MERCHANTABILITY AND FITNESS FOR A PARTICULAR PURPOSE. WELCH ALLYN'S OBLIGATION UNDER THIS WARRANTY IS LIMITED TO REPAIR OR REPLACEMENT OF PRODUCTS CONTAINING A DEFECT. WELCH ALLYN IS NOT RESPONSIBLE FOR ANY INDIRECT OR CONSEQUENTIAL DAMAGES RESULTING FROM A PRODUCT DEFECT COVERED BY THE WARRANTY.

### Integrated Wall System

Welch Allyn warrants the product to be free of defects in material and workmanship and to perform in accordance with manufacturer's specifications for the period of one year from the date of purchase from Welch Allyn or its authorized distributors or agents. The coiled cords carry a special 10-year warranty against breakage during normal usage.

The warranty period shall start on the date of purchase. The date of purchase is: 1) the invoiced ship date if the device was purchased directly from Welch Allyn, 2) the date specified during product registration, 3) the date of purchase of the product from a Welch Allyn authorized distributor as documented from a receipt from said distributor.

This warranty does not cover damage caused by: 1) handling during shipping, 2) use or maintenance contrary to labeled instructions, 3) alteration or repair by anyone not authorized by Welch Allyn, and 4) accidents.

The product warranty is also subject to the following terms and limitations: Accessories are not covered by the warranty. Refer to the instructions for use provided with individual accessories for warranty information.

A service notification number must be obtained from Welch Allyn prior to returning any products or accessories to Welch Allyn's designated service centers for repair. To obtain a service notification number, contact Welch Allyn Technical Support.

THIS WARRANTY IS IN LIEU OF ALL OTHER WARRANTIES, EXPRESS OR IMPLIED, INCLUDING BUT NOT LIMITED TO THE IMPLIED WARRANTIES OF MERCHANTABILITY AND FITNESS FOR A PARTICULAR PURPOSE. WELCH ALLYN'S OBLIGATION UNDER THIS WARRANTY IS LIMITED TO REPAIR OR REPLACEMENT OF PRODUCTS CONTAINING A DEFECT. WELCH ALLYN IS NOT RESPONSIBLE FOR ANY INDIRECT OR CONSEQUENTIAL DAMAGES RESULTING FROM A PRODUCT DEFECT COVERED BY THE WARRANTY.